

| | |
|-------------|-------|
| 21: | 10.7x |
| 22: | 9.9 ↑ |
| 23: | 9.9 ← |
| 24: | 10.3x |
| 25: | 9.2 ↑ |
| 26: | 9.9 ↓ |
| 27: | 9.9 ← |
| 28: | 9.2 ↖ |
| 29: | 9.8 ↓ |
| 30: | 9.7 ↑ |
| Serie 92.0 | |
| Total 637.0 | |

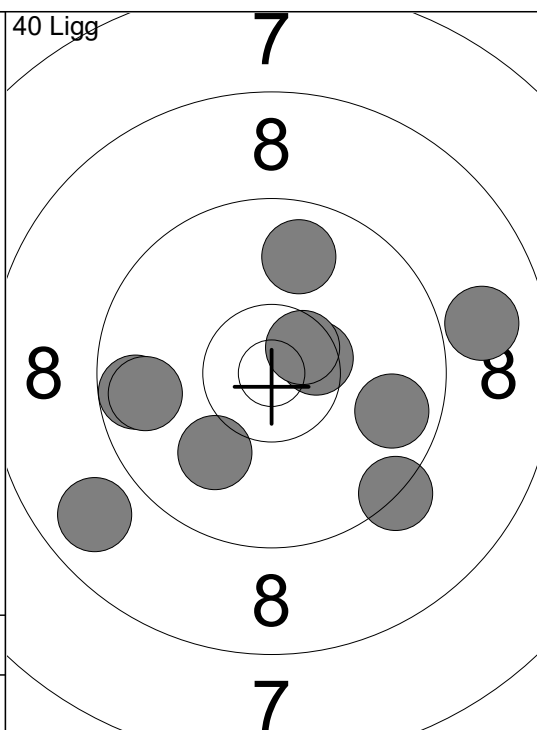

| | |
|-------------|--------|
| 31: | 10.5x |
| 32: | 9.8 → |
| 33: | 8.9 → |
| 34: | 8.8 ↙ |
| 35: | 9.8 ↑ |
| 36: | 10.6x |
| 37: | 9.3 ↘ |
| 38: | 9.7 ← |
| 39: | 10.0 ↙ |
| 40: | 9.7 ← |
| Serie 91.0 | |
| Total 728.0 | |

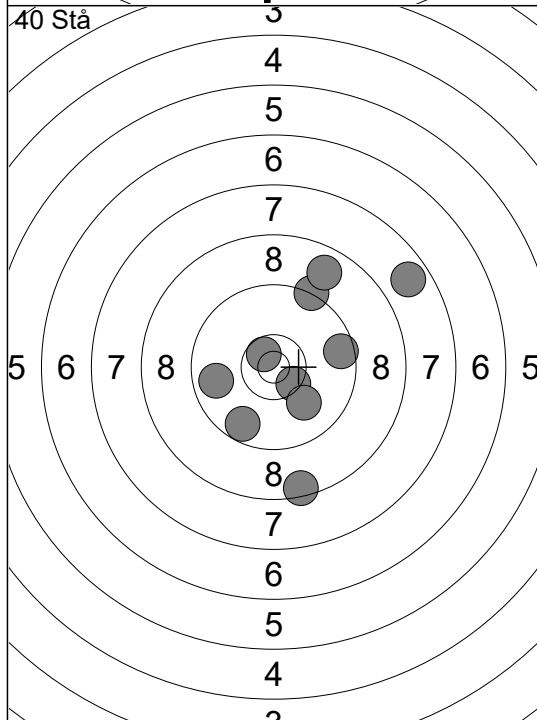

| | |
|-------------|--------|
| 1: | 9.6 ↙ |
| 2: | 10.6x |
| 3: | 9.8 ← |
| 4: | 10.4x |
| 5: | 9.6 → |
| 6: | 10.0 ↘ |
| 7: | 8.5 ↓ |
| 8: | 9.3 ↑ |
| 9: | 8.8 ↑ |
| 10: | 7.7 ↗ |
| Serie 89.0 | |
| Total 817.0 | |

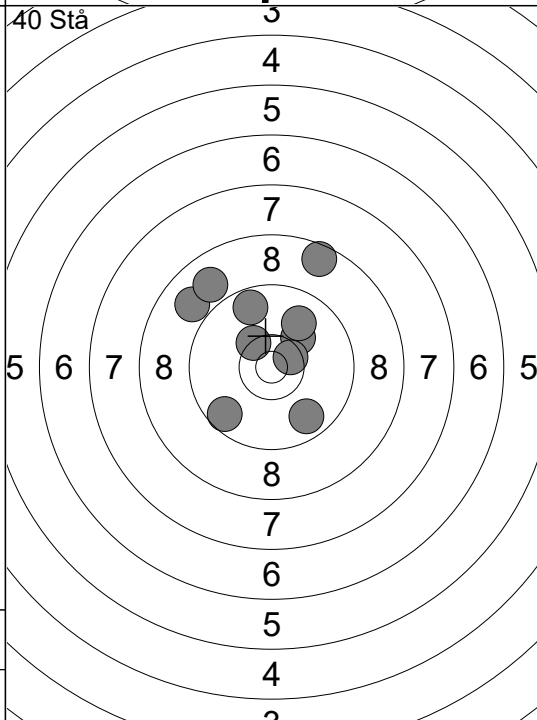

| | |
|-------------|--------|
| 11: | 10.2 ↗ |
| 12: | 8.6 ↑ |
| 13: | 9.6 ↙ |
| 14: | 8.9 ↖ |
| 15: | 10.3x |
| 16: | 8.9 ↖ |
| 17: | 9.7 ↘ |
| 18: | 9.9 ↑ |
| 19: | 10.5x |
| 20: | 9.7 ↑ |
| Serie 90.0 | |
| Total 907.0 | |

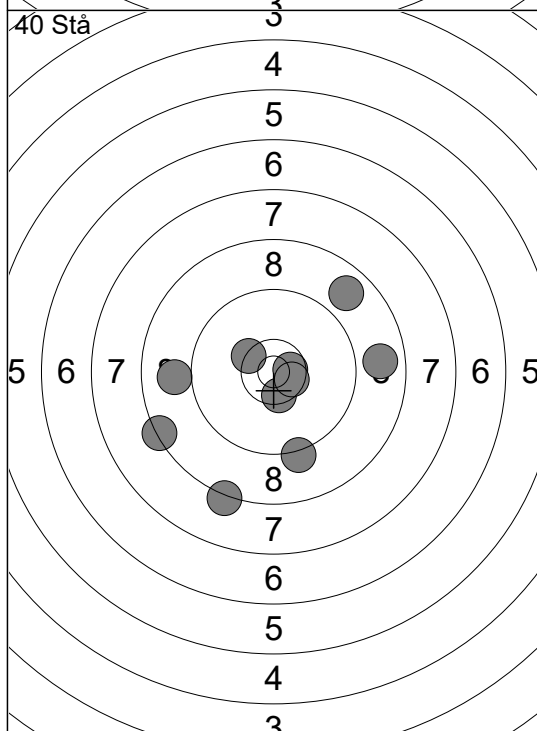

| | |
|-------------|-------|
| 21: | 9.2 ↓ |
| 22: | 8.8 → |
| 23: | 8.8 ↗ |
| 24: | 10.6x |
| 25: | 10.4x |
| 26: | 9.0 ← |
| 27: | 10.5x |
| 28: | 10.6x |
| 29: | 8.2 ↓ |
| 30: | 8.4 ← |
| Serie 90.0 | |
| Total 997.0 | |

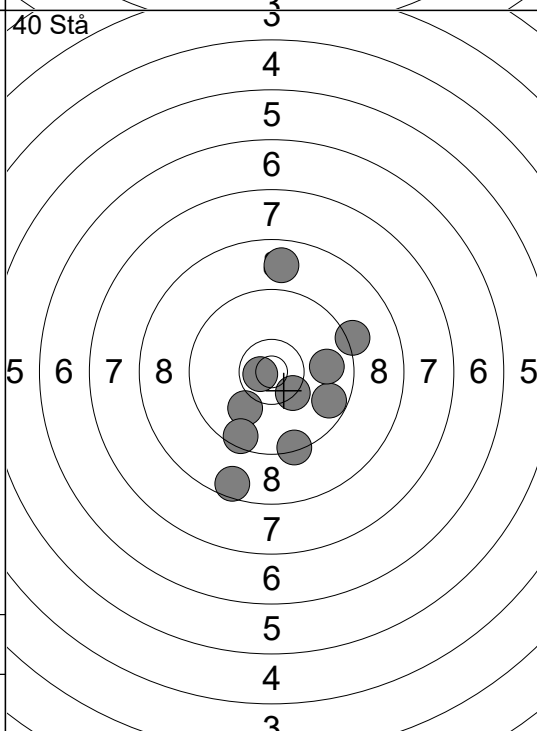

| | |
|--------------|--------|
| 31: | 8.6 ↓ |
| 32: | 9.7 → |
| 33: | 10.7x |
| 34: | 10.1 ↙ |
| 35: | 9.2 → |
| 36: | 10.4x |
| 37: | 9.8 → |
| 38: | 9.5 ↙ |
| 39: | 9.4 ↓ |
| 40: | 8.8 ↑ |
| Serie 91.0 | |
| Total 1088.0 | |

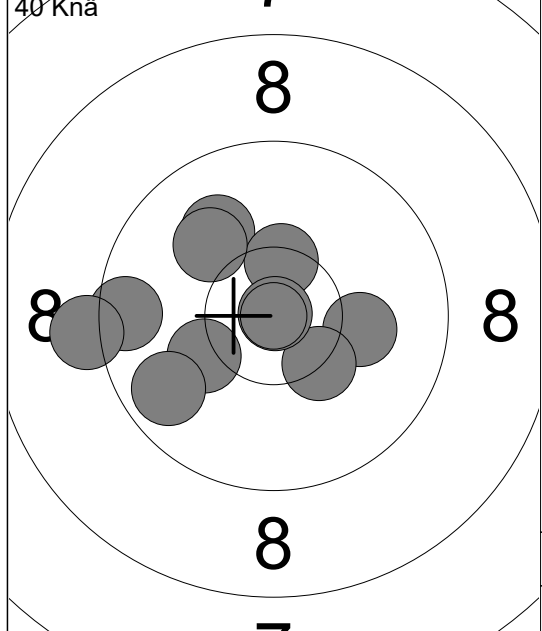

| | |
|------------|---------|
| 1: | 10.0 ↖ |
| 2: | 10.4x ↗ |
| 3: | 9.6 ← |
| 4: | 10.1 → |
| 5: | 9.2 ← |
| 6: | 10.2 ↙ |
| 7: | 9.7 ↙ |
| 8: | 10.3x ↘ |
| 9: | 10.1 ↖ |
| 10: | 10.9x ↗ |
| Serie 97.0 | |
| Total 97.0 | |

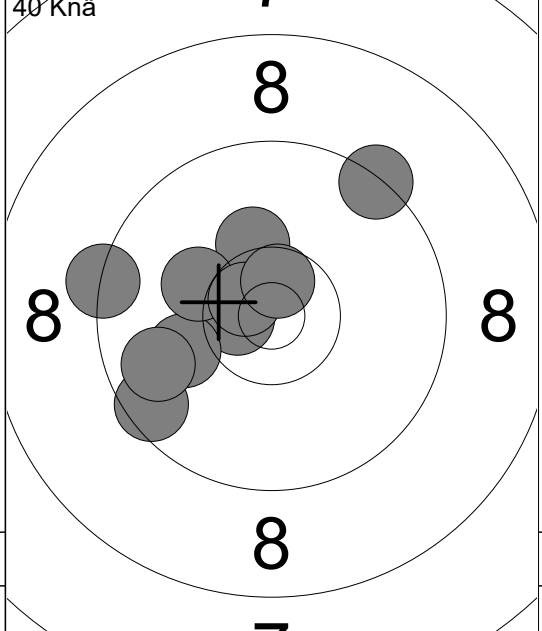

| | |
|-------------|---------|
| 11: | 10.6x ↖ |
| 12: | 10.1 ← |
| 13: | 9.4 ↗ |
| 14: | 10.2 ↗ |
| 15: | 9.5 ↙ |
| 16: | 10.2 ↙ |
| 17: | 10.7x ↘ |
| 18: | 9.8 ← |
| 19: | 10.6x ↗ |
| 20: | 9.3 ← |
| Serie 96.0 | |
| Total 193.0 | |

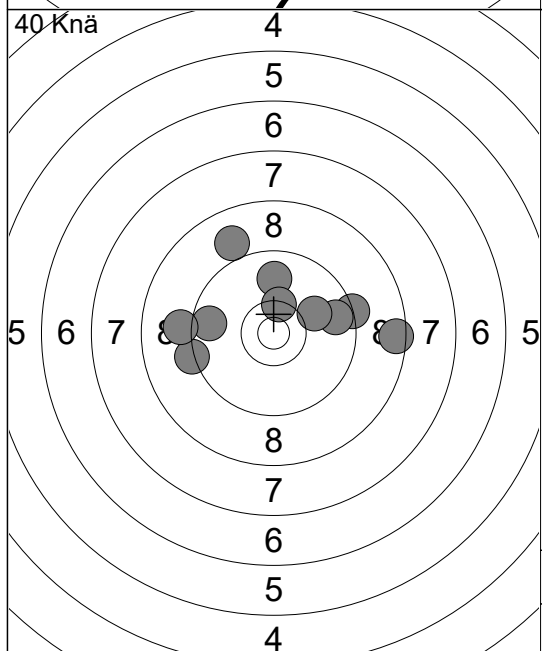

| | |
|-------------|---------|
| 21: | 9.3 ← |
| 22: | 9.0 ↖ |
| 23: | 9.3 → |
| 24: | 9.6 ← |
| 25: | 9.9 ↑ |
| 26: | 9.1 ← |
| 27: | 10.4x ↗ |
| 28: | 9.7 → |
| 29: | 10.0 → |
| 30: | 8.5 → |
| Serie 91.0 | |
| Total 284.0 | |

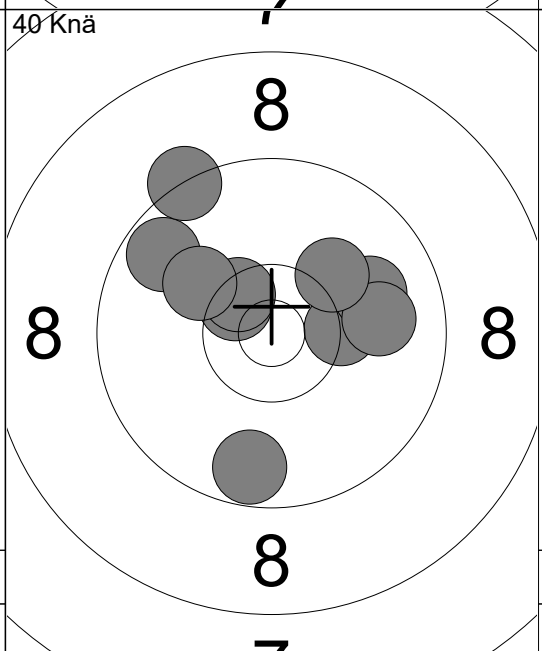

| | |
|-------------|---------|
| 31: | 9.7 ↓ |
| 32: | 10.3x → |
| 33: | 9.9 → |
| 34: | 9.9 → |
| 35: | 10.2 ↗ |
| 36: | 10.5x ↘ |
| 37: | 10.5x ↘ |
| 38: | 9.7 ↖ |
| 39: | 10.1 ↖ |
| 40: | 9.3 ↖ |
| Serie 95.0 | |
| Total 379.0 | |

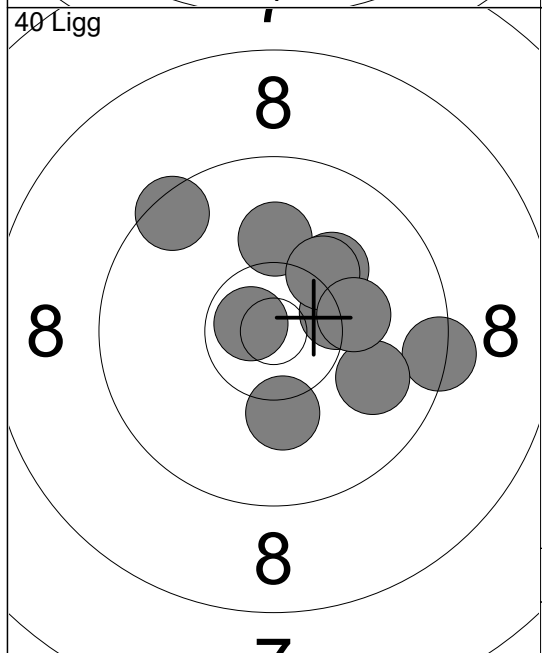

| | |
|-------------|---------|
| 1: | 10.3x → |
| 2: | 10.1 ↗ |
| 3: | 10.7x ↘ |
| 4: | 9.4 → |
| 5: | 9.9 → |
| 6: | 10.2 ↓ |
| 7: | 9.5 ↖ |
| 8: | 10.1 ↑ |
| 9: | 10.2 ↗ |
| 10: | 10.2 → |
| Serie 97.0 | |
| Total 476.0 | |

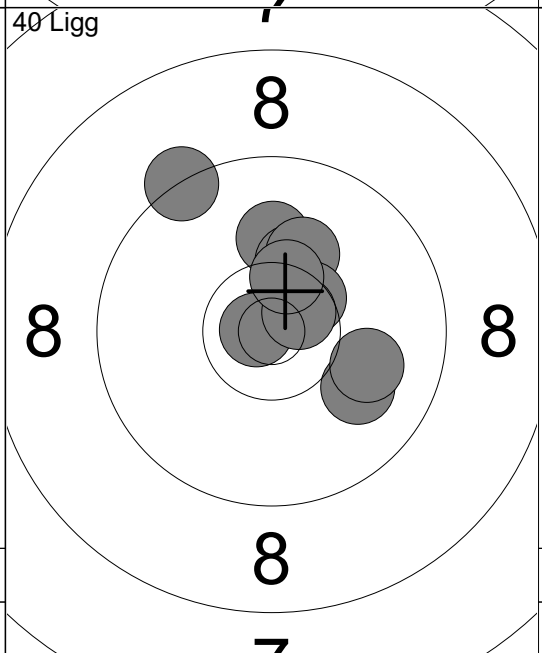

| | |
|-------------|---------|
| 11: | 10.1 ↑ |
| 12: | 10.3 ↑ |
| 13: | 10.0 → |
| 14: | 10.2 ↗ |
| 15: | 10.5x ↗ |
| 16: | 9.3 ↖ |
| 17: | 10.8x ↘ |
| 18: | 10.6x ↗ |
| 19: | 10.4x ↗ |
| 20: | 10.0 → |
| Serie 99.0 | |
| Total 575.0 | |

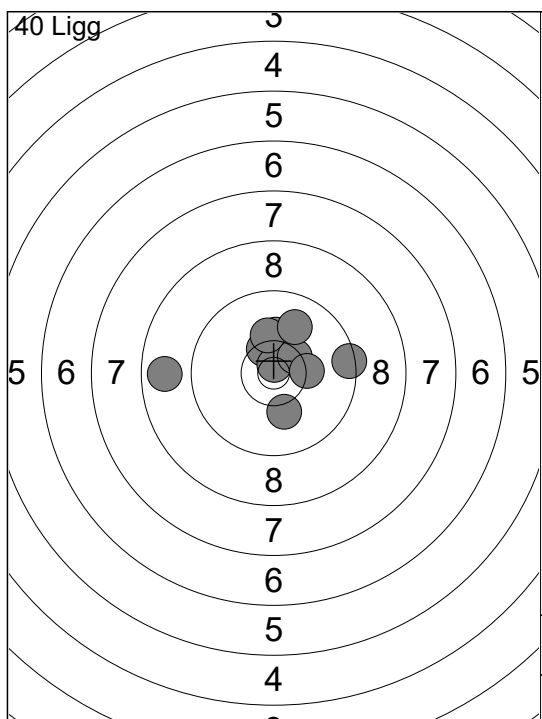

| | | |
|-------|-------|---|
| 21: | 10.2 | ↑ |
| 22: | 10.4 | ↖ |
| 23: | 8.8 | ← |
| 24: | 10.8 | ↗ |
| 25: | 9.4 | → |
| 26: | 10.2 | ↑ |
| 27: | 10.4 | ↗ |
| 28: | 10.3 | → |
| 29: | 9.9 | ↗ |
| 30: | 10.2 | ↓ |
| Serie | 96.0 | |
| Total | 671.0 | |

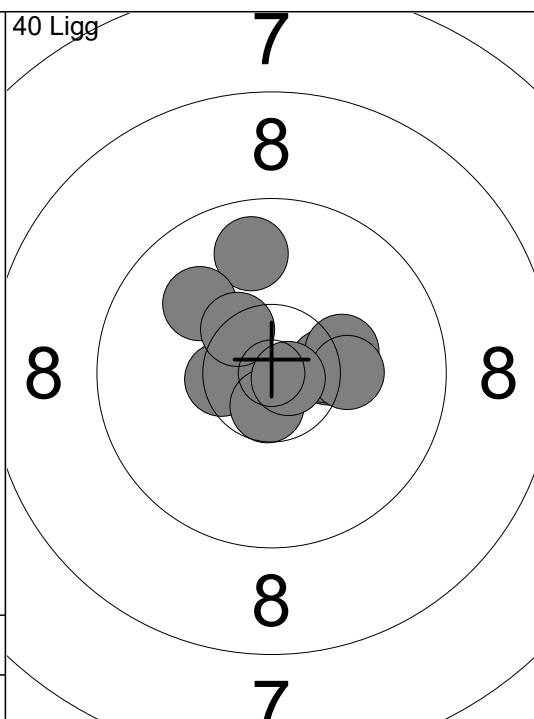

| | | |
|-------|-------|---|
| 31: | 10.4 | ↘ |
| 32: | 9.8 | ↑ |
| 33: | 10.5 | ↖ |
| 34: | 10.0 | ↖ |
| 35: | 10.4 | ↖ |
| 36: | 10.4 | ↘ |
| 37: | 10.3 | → |
| 38: | 10.2 | → |
| 39: | 10.6 | ↓ |
| 40: | 10.8 | ↘ |
| Serie | 99.0 | |
| Total | 770.0 | |

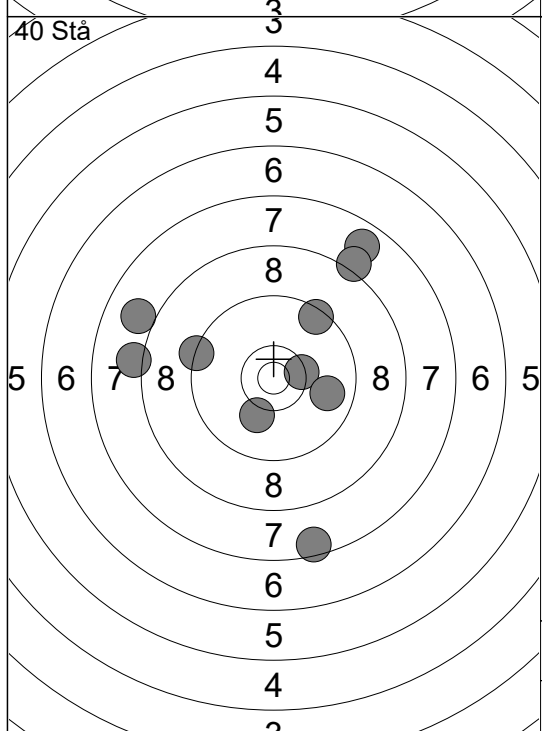

| | | |
|-------|-------|---|
| 1: | 7.8 | ↗ |
| 2: | 10.4 | ↘ |
| 3: | 8.0 | ← |
| 4: | 9.8 | → |
| 5: | 8.1 | ← |
| 6: | 8.2 | ↗ |
| 7: | 9.5 | ↗ |
| 8: | 7.5 | ↓ |
| 9: | 9.3 | ← |
| 10: | 10.1 | ↓ |
| Serie | 85.0 | |
| Total | 855.0 | |

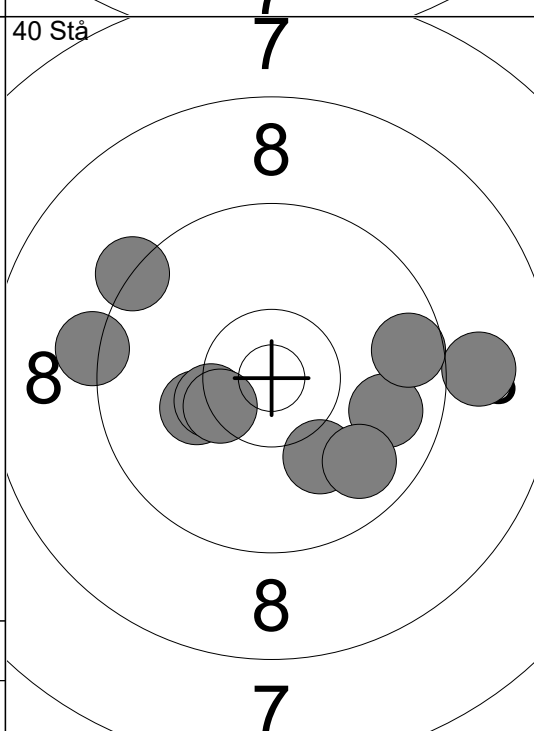

| | | |
|-------|-------|---|
| 11: | 10.2 | ↖ |
| 12: | 9.8 | → |
| 13: | 9.0 | → |
| 14: | 10.1 | ↓ |
| 15: | 10.3 | ↖ |
| 16: | 10.4 | ↖ |
| 17: | 9.2 | ← |
| 18: | 9.3 | ↖ |
| 19: | 9.8 | ↓ |
| 20: | 9.6 | → |
| Serie | 94.0 | |
| Total | 949.0 | |

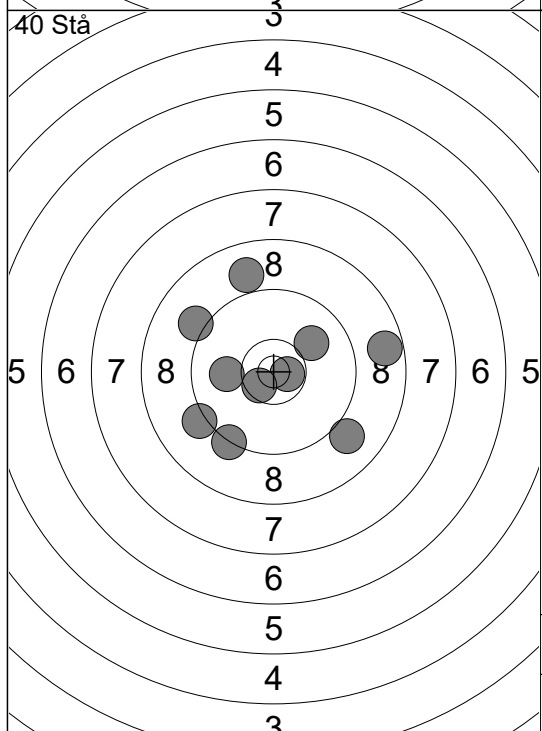

| | | |
|-------|--------|---|
| 21: | 9.1 | ↖ |
| 22: | 9.2 | ↖ |
| 23: | 8.9 | ↑ |
| 24: | 9.3 | ↓ |
| 25: | 10.7 | ↘ |
| 26: | 10.0 | ↗ |
| 27: | 9.0 | ↓ |
| 28: | 10.0 | ← |
| 29: | 8.7 | → |
| 30: | 10.6 | ↖ |
| Serie | 92.0 | |
| Total | 1041.0 | |

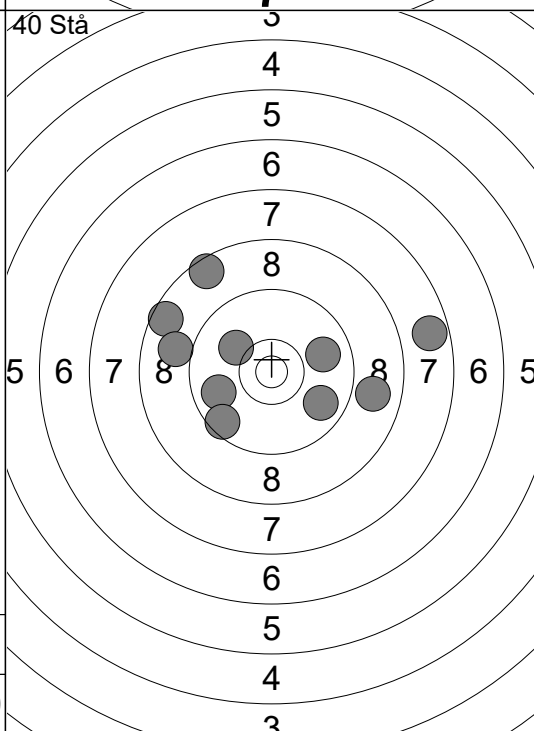

| | | |
|-------|--------|---|
| 31: | 8.6 | ↖ |
| 32: | 8.9 | → |
| 33: | 9.0 | ← |
| 34: | 9.8 | ← |
| 35: | 10.1 | ↖ |
| 36: | 9.9 | → |
| 37: | 8.6 | ↖ |
| 38: | 7.7 | → |
| 39: | 9.8 | ↓ |
| 40: | 9.5 | ↖ |
| Serie | 86.0 | |
| Total | 1127.0 | |

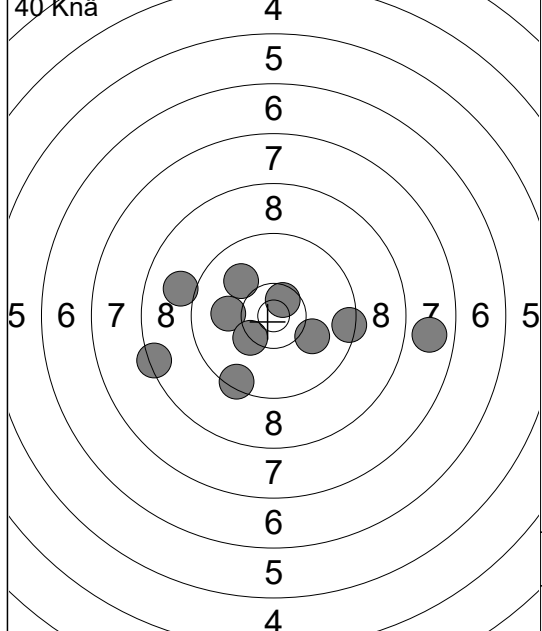

| |
|-------------|
| 1: 8.4 ← |
| 2: 9.4 ↓ |
| 3: 9.0 ← |
| 4: 10.0 ← |
| 5: 10.3x ↘ |
| 6: 7.8 → |
| 7: 9.4 → |
| 8: 10.1 → |
| 9: 10.0 ↖ |
| 10: 10.6x ↗ |
| Serie 92.0 |
| Total 92.0 |

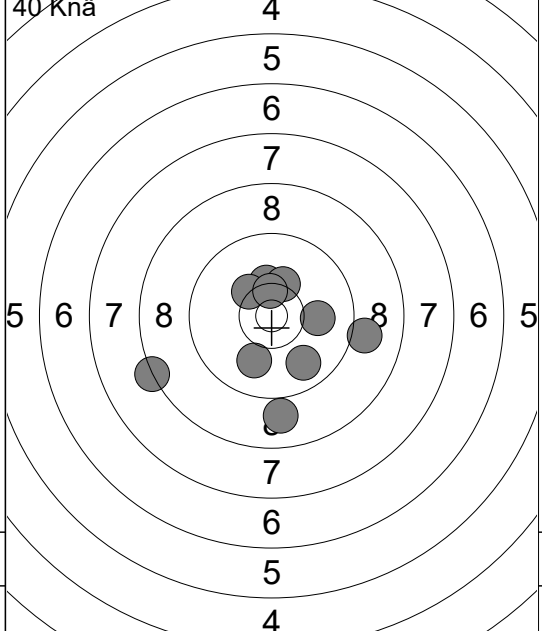

| |
|-------------|
| 11: 10.3 ↑ |
| 12: 10.3 ↗ |
| 13: 8.9 ↓ |
| 14: 9.8 ↓ |
| 15: 9.0 → |
| 16: 8.3 ← |
| 17: 10.3 ↖ |
| 18: 10.0 ↓ |
| 19: 10.0 → |
| 20: 10.4x ↗ |
| Serie 94.0 |
| Total 186.0 |

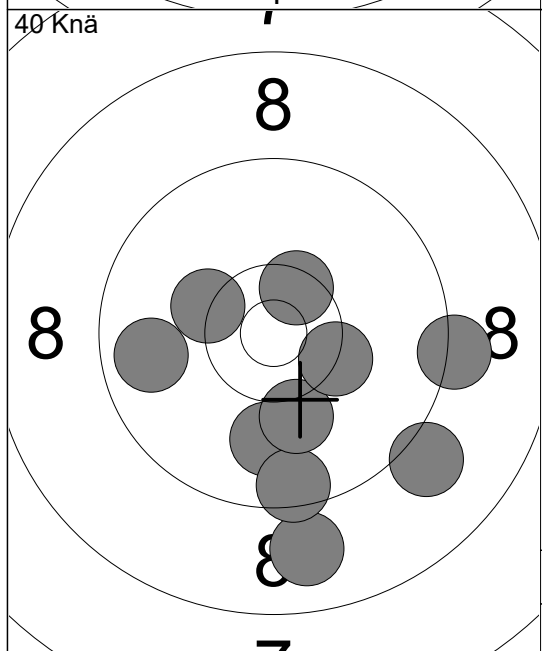

| |
|-------------|
| 21: 9.8 ← |
| 22: 10.3 ↖ |
| 23: 9.1 ↓ |
| 24: 10.0 ↓ |
| 25: 9.2 → |
| 26: 8.9 ↓ |
| 27: 10.5x ↗ |
| 28: 9.5 ↓ |
| 29: 10.1 ↓ |
| 30: 10.3x → |
| Serie 94.0 |
| Total 280.0 |

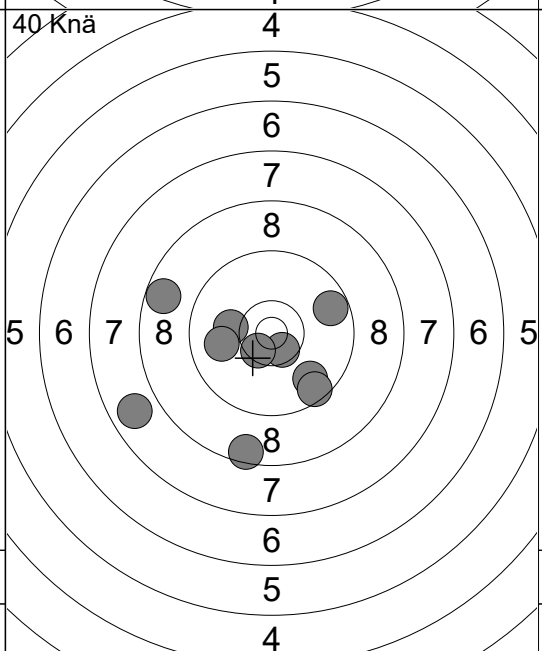

| |
|-------------|
| 31: 9.8 ↓ |
| 32: 10.6x ↘ |
| 33: 10.1 ← |
| 34: 9.5 ↓ |
| 35: 10.5x ↘ |
| 36: 9.7 → |
| 37: 9.9 ← |
| 38: 7.8 ← |
| 39: 8.7 ← |
| 40: 8.5 ↓ |
| Serie 89.0 |
| Total 369.0 |

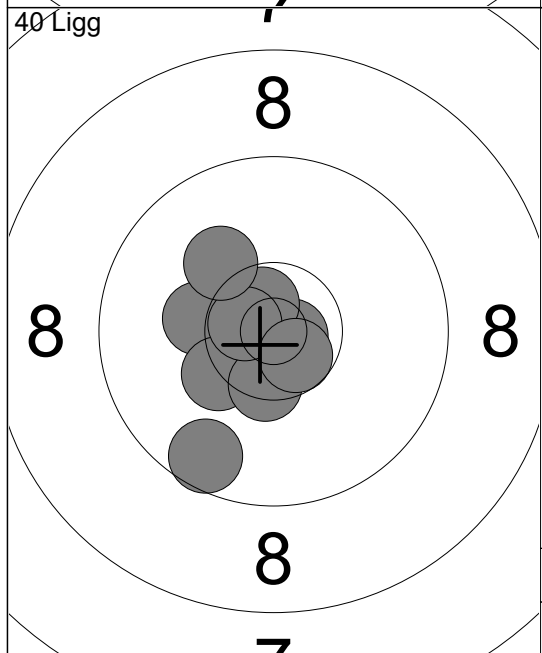

| |
|-------------|
| 1: 9.6 ↓ |
| 2: 10.8x → |
| 3: 10.2 ← |
| 4: 10.7x ↓ |
| 5: 10.3x ↘ |
| 6: 10.4x ↓ |
| 7: 10.7x ↗ |
| 8: 10.7x ↘ |
| 9: 10.1 ↖ |
| 10: 10.6x ↘ |
| Serie 99.0 |
| Total 468.0 |

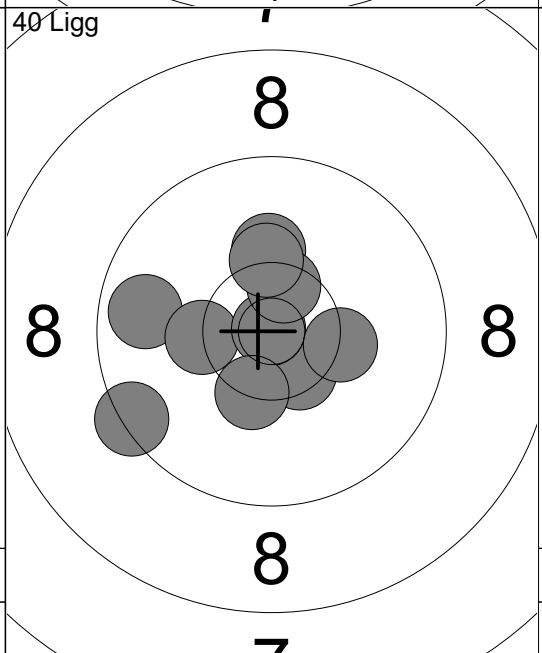

| |
|-------------|
| 11: 9.7 ← |
| 12: 10.2 ↑ |
| 13: 10.5x ↘ |
| 14: 10.3x ↖ |
| 15: 10.9x ↘ |
| 16: 9.4 ← |
| 17: 10.5x ↗ |
| 18: 10.3 → |
| 19: 10.3 ↑ |
| 20: 10.3x ↘ |
| Serie 98.0 |
| Total 566.0 |

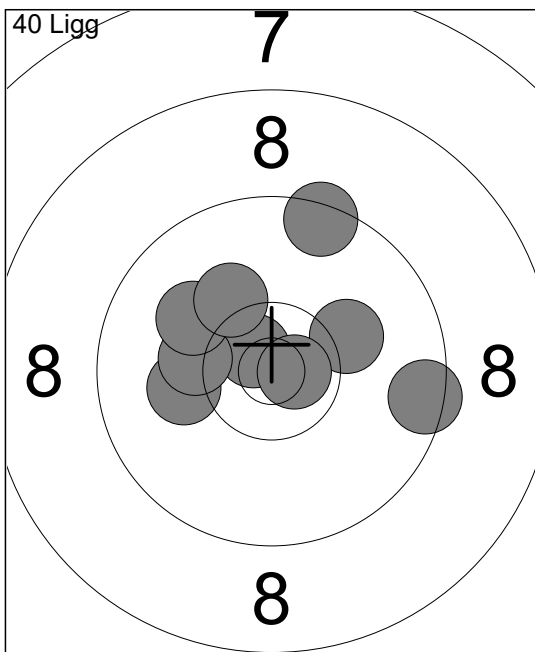

| | | |
|-----|------|---|
| 21: | 10.2 | → |
| 22: | 10.1 | ← |
| 23: | 10.3 | ↖ |
| 24: | 10.7 | ↖ |
| 25: | 10.7 | ↗ |
| 26: | 10.2 | ← |
| 27: | 9.4 | ↑ |
| 28: | 10.1 | ↖ |
| 29: | 10.2 | ↗ |
| 30: | 9.5 | → |

| | |
|-------|-------|
| Serie | 98.0 |
| Total | 664.0 |

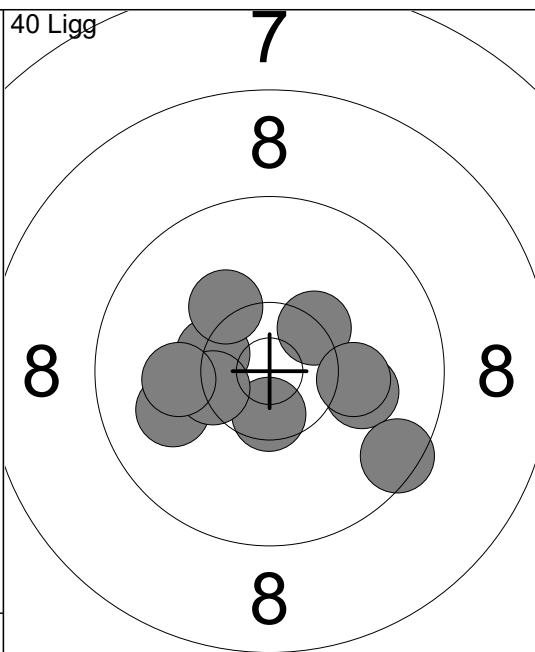

| | | |
|-----|------|---|
| 31: | 10.4 | ↗ |
| 32: | 10.0 | ← |
| 33: | 10.5 | ↓ |
| 34: | 10.1 | → |
| 35: | 9.5 | ↘ |
| 36: | 10.4 | ↖ |
| 37: | 10.4 | ↖ |
| 38: | 10.2 | ↖ |
| 39: | 10.1 | ← |
| 40: | 10.2 | → |

| | |
|-------|-------|
| Serie | 99.0 |
| Total | 763.0 |

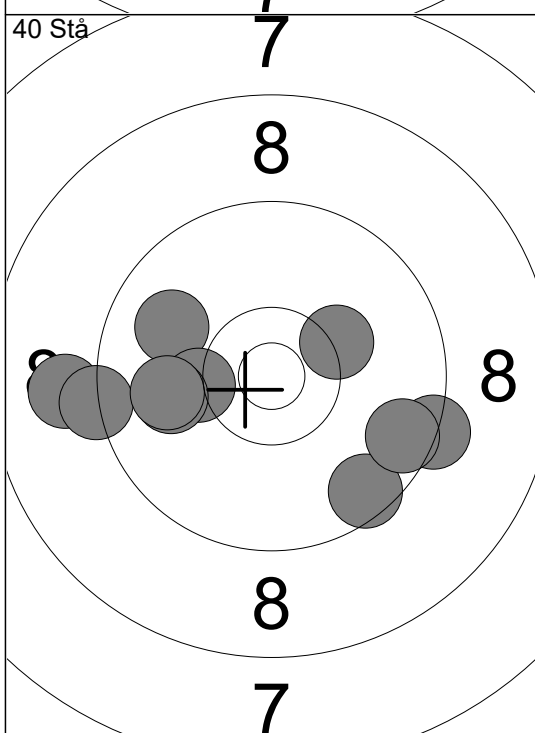

| | | |
|-----|------|---|
| 1: | 9.9 | ↖ |
| 2: | 9.0 | ← |
| 3: | 9.6 | ↘ |
| 4: | 9.3 | → |
| 5: | 9.3 | ← |
| 6: | 10.3 | ↗ |
| 7: | 10.3 | ← |
| 8: | 10.0 | ← |
| 9: | 10.0 | ← |
| 10: | 9.6 | → |

| | |
|-------|-------|
| Serie | 94.0 |
| Total | 857.0 |

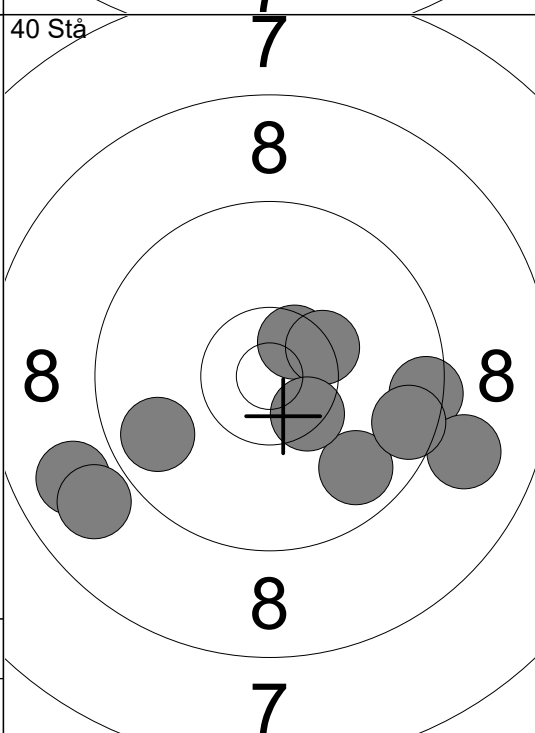

| | | |
|-----|------|---|
| 11: | 10.6 | ↗ |
| 12: | 8.9 | ← |
| 13: | 9.5 | → |
| 14: | 9.8 | ↘ |
| 15: | 10.4 | ↗ |
| 16: | 9.0 | → |
| 17: | 10.4 | ↖ |
| 18: | 9.8 | ← |
| 19: | 9.6 | → |
| 20: | 8.9 | ← |

| | |
|-------|-------|
| Serie | 91.0 |
| Total | 948.0 |

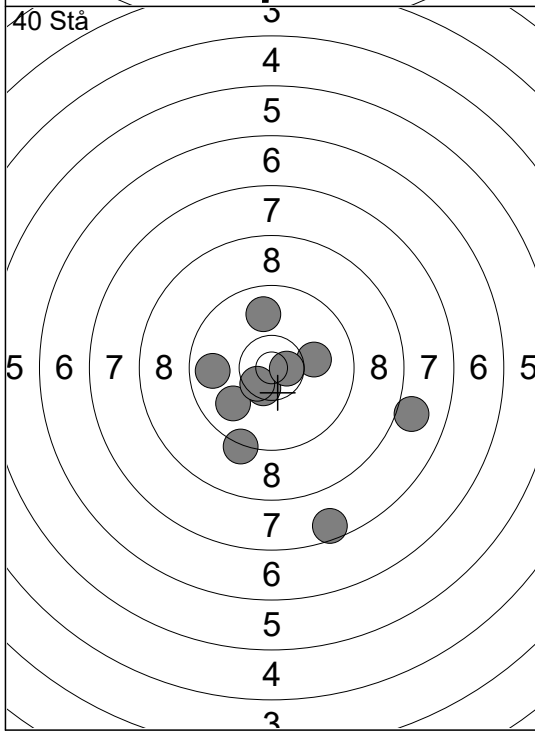

| | | |
|-----|------|---|
| 21: | 8.0 | → |
| 22: | 9.3 | ↓ |
| 23: | 10.5 | ↖ |
| 24: | 9.8 | ← |
| 25: | 9.9 | ↖ |
| 26: | 10.5 | ↖ |
| 27: | 10.1 | → |
| 28: | 10.6 | ↗ |
| 29: | 9.9 | ↑ |
| 30: | 7.6 | ↓ |

| | |
|-------|--------|
| Serie | 91.0 |
| Total | 1039.0 |

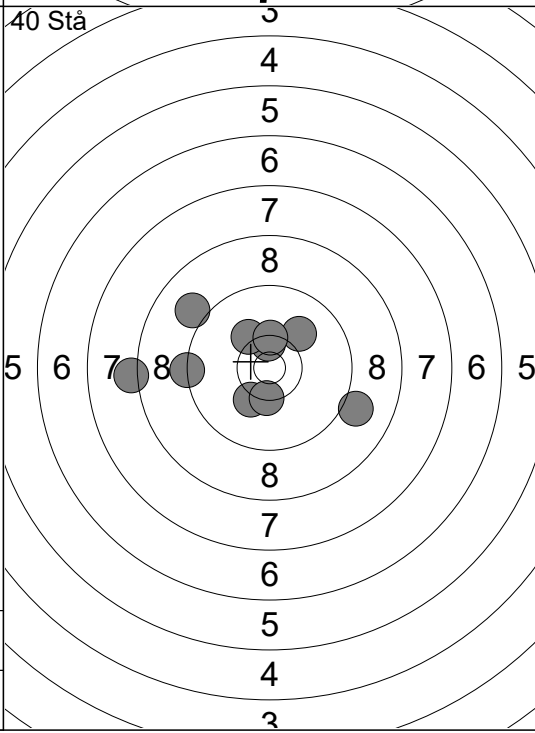

| | | |
|-----|------|---|
| 31: | 10.5 | ↗ |
| 32: | 8.2 | ← |
| 33: | 10.2 | ↓ |
| 34: | 9.3 | ← |
| 35: | 9.0 | ↖ |
| 36: | 10.3 | ↓ |
| 37: | 10.0 | ↗ |
| 38: | 9.0 | ↘ |
| 39: | 10.2 | ↖ |
| 40: | 10.3 | ↗ |

| | |
|-------|--------|
| Serie | 95.0 |
| Total | 1134.0 |

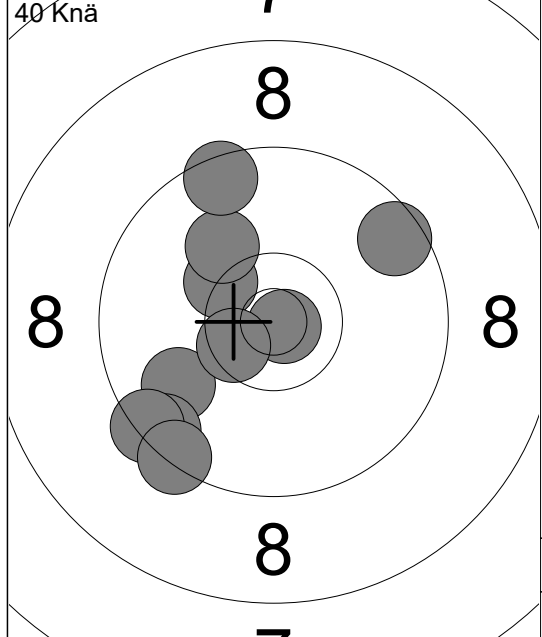

| | | |
|-------|------|------|
| 1: | 9.9 | ↙ |
| 2: | 9.5 | ↙ |
| 3: | 10.8 | x→ |
| 4: | 10.3 | x↘ |
| 5: | 9.4 | ↙ |
| 6: | 9.6 | ↗ |
| 7: | 9.4 | ↙ |
| 8: | 10.1 | ↖ |
| 9: | 10.5 | x↘ |
| 10: | 9.5 | ↖ |
| Serie | | 94.0 |
| Total | | 94.0 |

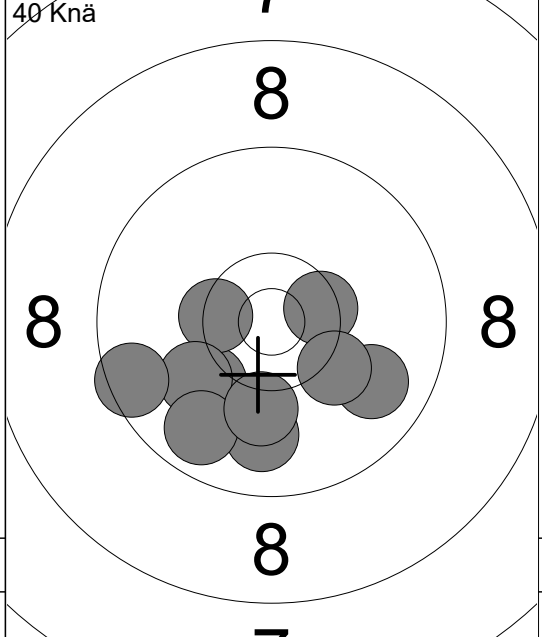

| | | |
|-------|------|-------|
| 11: | 10.1 | ↙ |
| 12: | 9.9 | ↓ |
| 13: | 9.9 | → |
| 14: | 10.4 | x↘ |
| 15: | 10.5 | x→ |
| 16: | 10.1 | ↙ |
| 17: | 9.5 | ↙ |
| 18: | 9.8 | ↙ |
| 19: | 10.2 | ↘ |
| 20: | 10.1 | ↓ |
| Serie | | 96.0 |
| Total | | 190.0 |

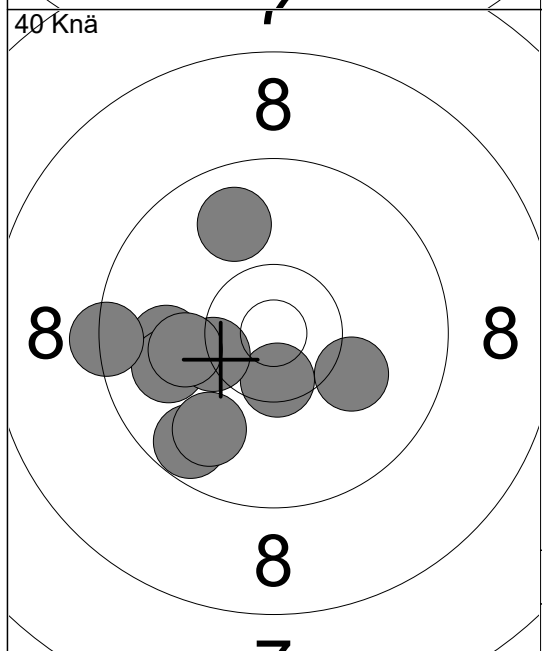

| | | |
|-------|------|-------|
| 21: | 10.1 | → |
| 22: | 9.9 | ← |
| 23: | 9.7 | ↙ |
| 24: | 9.9 | ← |
| 25: | 10.5 | x↓ |
| 26: | 10.3 | x↘ |
| 27: | 10.1 | ← |
| 28: | 9.4 | ← |
| 29: | 9.9 | ↖ |
| 30: | 9.9 | ↙ |
| Serie | | 94.0 |
| Total | | 284.0 |

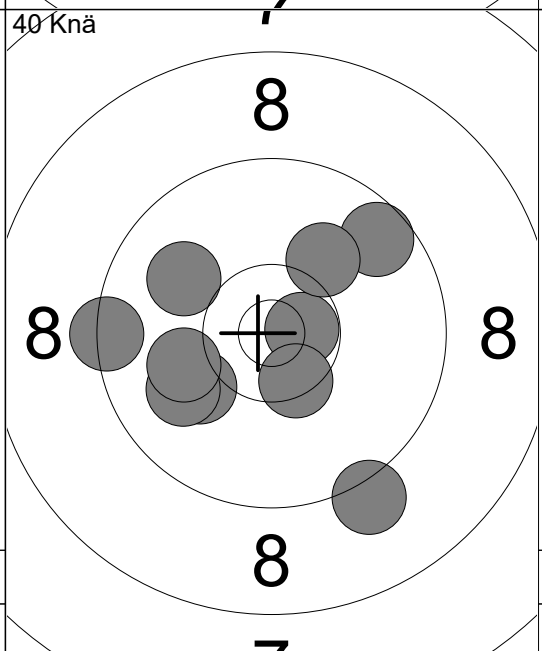

| | | |
|-------|------|-------|
| 31: | 10.1 | ↙ |
| 32: | 10.0 | ↙ |
| 33: | 10.7 | x→ |
| 34: | 10.4 | x↓ |
| 35: | 9.4 | ← |
| 36: | 9.6 | ↗ |
| 37: | 10.1 | ↖ |
| 38: | 10.0 | ↘ |
| 39: | 10.1 | ← |
| 40: | 9.1 | ↓ |
| Serie | | 97.0 |
| Total | | 381.0 |

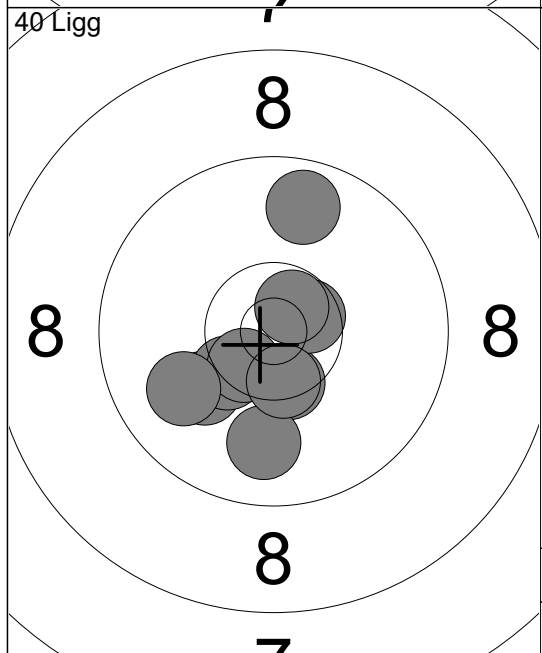

| | | |
|-------|------|-------|
| 1: | 10.1 | ↙ |
| 2: | 10.4 | x↓ |
| 3: | 10.6 | x→ |
| 4: | 10.4 | x↘ |
| 5: | 9.9 | ↓ |
| 6: | 10.5 | x↘ |
| 7: | 9.9 | ↙ |
| 8: | 9.7 | ↖ |
| 9: | 10.5 | x↓ |
| 10: | 10.7 | x↗ |
| Serie | | 97.0 |
| Total | | 478.0 |

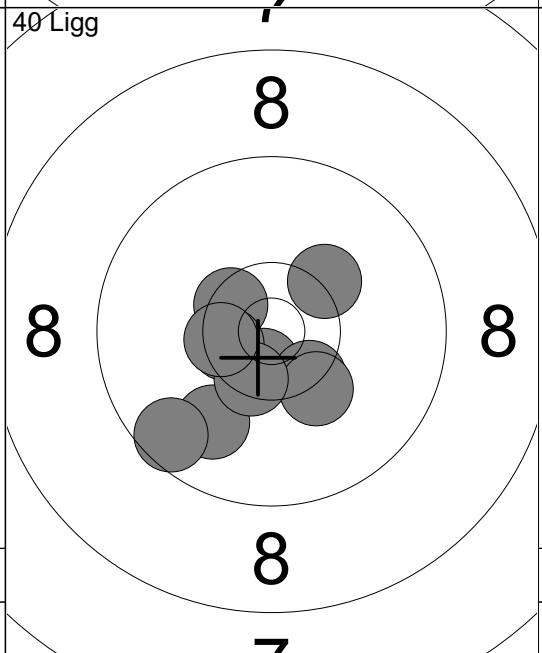

| | | |
|-------|------|-------|
| 11: | 10.6 | x↓ |
| 12: | 10.4 | x↓ |
| 13: | 10.5 | x↘ |
| 14: | 9.9 | ↙ |
| 15: | 10.3 | ↘ |
| 16: | 10.5 | x↘ |
| 17: | 10.5 | x↓ |
| 18: | 10.5 | x↘ |
| 19: | 9.6 | ↙ |
| 20: | 10.3 | ↗ |
| Serie | | 98.0 |
| Total | | 576.0 |

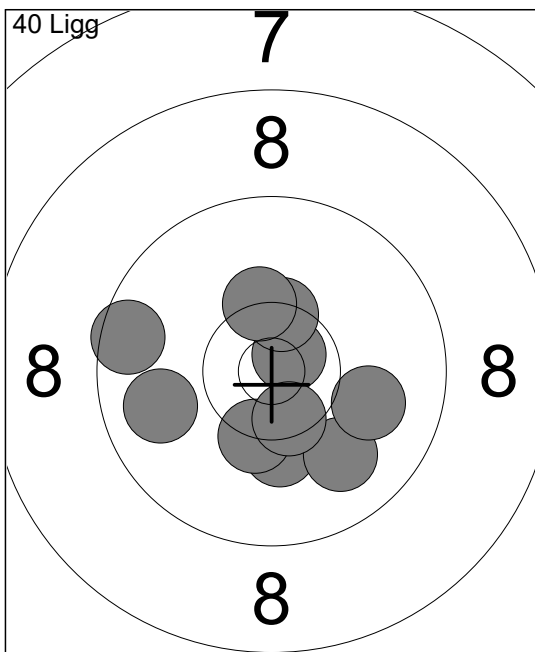

| | |
|-----|---------|
| 21: | 10.7x ↗ |
| 22: | 10.2 ↓ |
| 23: | 9.9 ↘ |
| 24: | 10.0 → |
| 25: | 10.4x ↗ |
| 26: | 9.6 ← |
| 27: | 10.3x ↗ |
| 28: | 10.3x ↘ |
| 29: | 10.5x ↘ |
| 30: | 9.9 ← |

| | |
|-------|-------|
| Serie | 97.0 |
| Total | 673.0 |

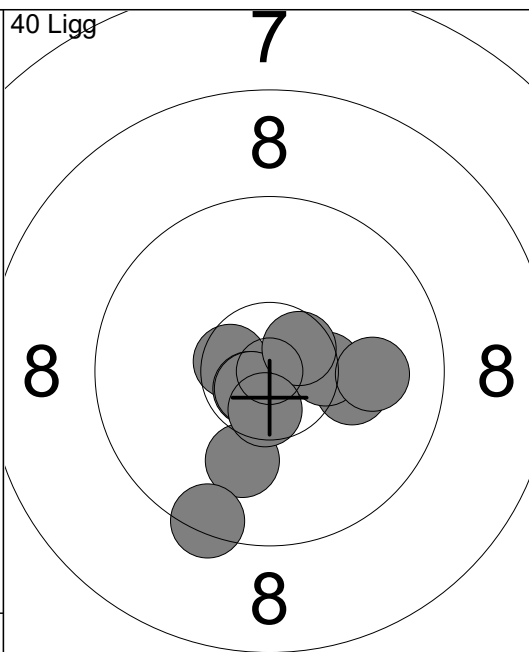

| | |
|-----|---------|
| 31: | 10.6x ↘ |
| 32: | 10.1 ↓ |
| 33: | 10.7x ↘ |
| 34: | 10.7x ↘ |
| 35: | 10.2 → |
| 36: | 10.4x → |
| 37: | 9.4 ↓ |
| 38: | 10.0 → |
| 39: | 10.6x ↗ |
| 40: | 10.6x ↘ |

| | |
|-------|-------|
| Serie | 99.0 |
| Total | 772.0 |

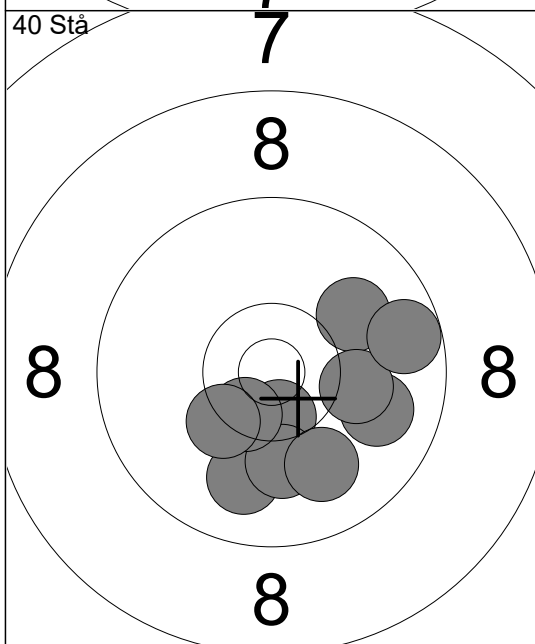

| | |
|-----|---------|
| 1: | 9.9 ↓ |
| 2: | 10.5x ↘ |
| 3: | 10.1 ↓ |
| 4: | 10.0 ↓ |
| 5: | 10.0 ↗ |
| 6: | 10.5x ↘ |
| 7: | 9.9 → |
| 8: | 10.1 → |
| 9: | 10.3x ↘ |
| 10: | 9.7 → |

| | |
|-------|-------|
| Serie | 97.0 |
| Total | 869.0 |

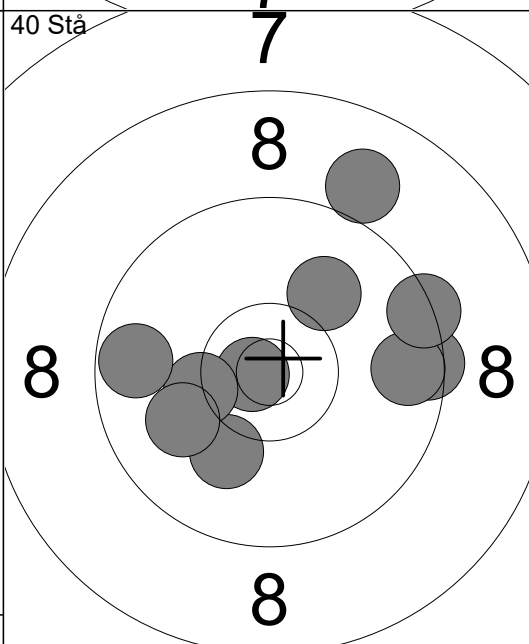

| | |
|-----|---------|
| 11: | 10.0 ↗ |
| 12: | 9.0 ↗ |
| 13: | 10.1 ↘ |
| 14: | 9.5 → |
| 15: | 10.8x ↘ |
| 16: | 9.6 → |
| 17: | 10.3 ↙ |
| 18: | 10.0 ↙ |
| 19: | 9.7 ← |
| 20: | 9.4 → |

| | |
|-------|-------|
| Serie | 95.0 |
| Total | 964.0 |

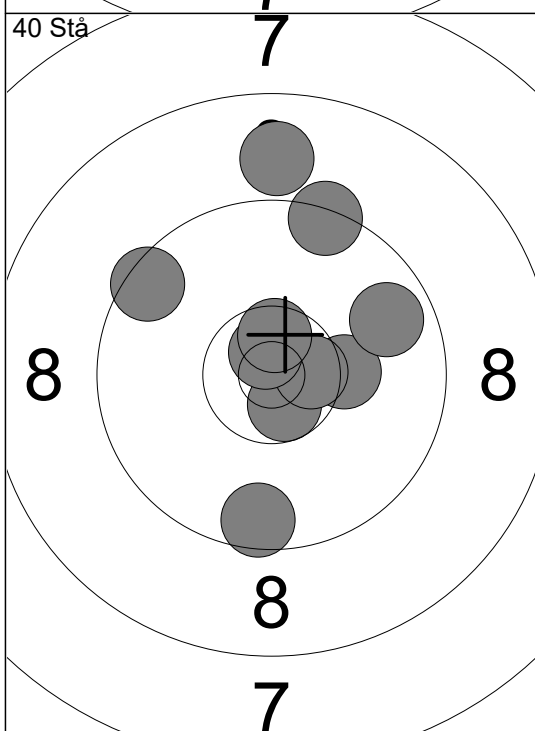

| | |
|-----|---------|
| 21: | 9.4 ↗ |
| 22: | 10.3 → |
| 23: | 10.6x ↘ |
| 24: | 9.7 → |
| 25: | 10.6x → |
| 26: | 9.6 ↓ |
| 27: | 10.7x ↗ |
| 28: | 10.6x ↗ |
| 29: | 9.5 ↙ |
| 30: | 8.9 ↗ |

| | |
|-------|--------|
| Serie | 94.0 |
| Total | 1058.0 |

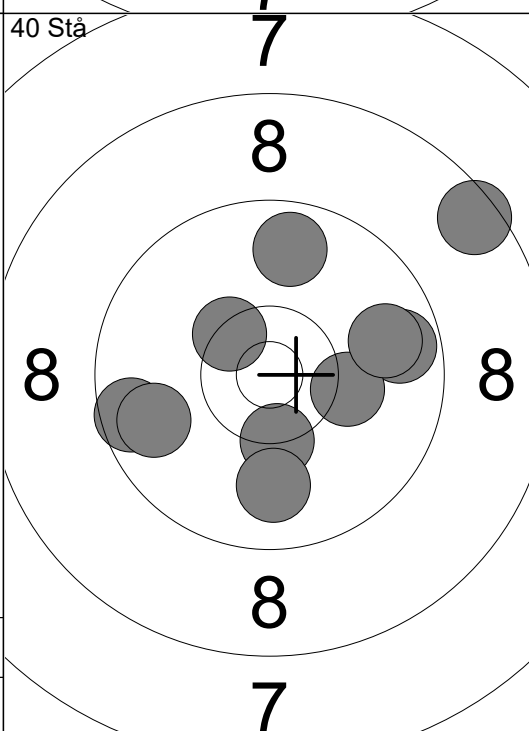

| | |
|-----|---------|
| 31: | 9.7 → |
| 32: | 8.5 ↗ |
| 33: | 10.2 → |
| 34: | 9.8 → |
| 35: | 9.6 ← |
| 36: | 10.3x ↘ |
| 37: | 9.7 ↗ |
| 38: | 9.9 ↓ |
| 39: | 10.4x ↘ |
| 40: | 9.8 ← |

| | |
|-------|--------|
| Serie | 92.0 |
| Total | 1150.0 |

| | | | |
|---------------|--|---------------|--|
| <p>40 Knä</p> | <p>1: 9.7 ↙ 2: 10.2 ↑ 3: 10.2 ← 4: 10.4x ↘ 5: 10.6x ↘ 6: 10.3x ↑ 7: 9.3 ← 8: 10.1 ← 9: 10.1 ↙ 10: 10.3x ↘</p> <p>Serie 98.0 Total 98.0</p> | <p>40 Knä</p> | <p>11: 10.0 ↑ 12: 9.8 ↑ 13: 9.8 ↙ 14: 9.5 → 15: 10.6x ↘ 16: 10.4x ↘ 17: 10.6x ↑ 18: 10.3 → 19: 10.5x ↘ 20: 10.3x →</p> <p>Serie 97.0 Total 195.0</p> |
|---------------|--|---------------|--|

| | | | |
|---------------|---|---------------|--|
| <p>40 Knä</p> | <p>21: 10.0 → 22: 9.2 → 23: 9.7 ↑ 24: 10.5x → 25: 10.5x ↘ 26: 10.7x → 27: 10.5x ↘ 28: 10.0 → 29: 10.4x ↘ 30: 10.0 ↓</p> <p>Serie 98.0 Total 293.0</p> | <p>40 Knä</p> | <p>31: 9.9 ← 32: 10.3 ↙ 33: 10.5x ↘ 34: 10.4x ↘ 35: 10.3 → 36: 10.3 ↑ 37: 10.2 → 38: 10.0 ← 39: 10.0 ↓ 40: 10.5x ↗</p> <p>Serie 99.0 Total 392.0</p> |
|---------------|---|---------------|--|

| | | | |
|----------------|--|----------------|---|
| <p>40 Ligg</p> | <p>1: 10.4x ↑ 2: 9.8 ← 3: 10.5x ↘ 4: 10.4x ↘ 5: 10.7x ↘ 6: 10.2 ↑ 7: 10.0 ↓ 8: 9.6 → 9: 10.4x ↑ 10: 10.2 →</p> <p>Serie 98.0 Total 490.0</p> | <p>40 Ligg</p> | <p>11: 10.3x ↘ 12: 9.4 → 13: 9.8 → 14: 10.6x ↘ 15: 10.3 → 16: 10.0 → 17: 9.7 → 18: 10.8x ↑ 19: 10.4x ↗ 20: 10.2 →</p> <p>Serie 97.0 Total 587.0</p> |
|----------------|--|----------------|---|

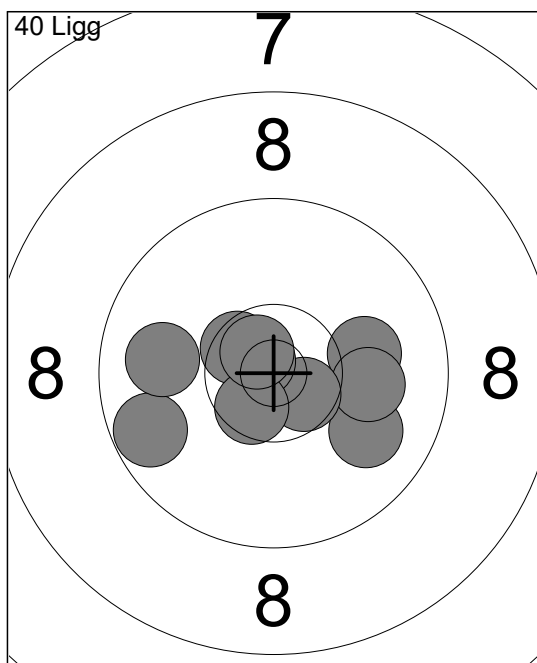

| | | |
|-------|------|-------|
| 21: | 9.9 | ↘ |
| 22: | 10.1 | → |
| 23: | 10.1 | → |
| 24: | 10.6 | ↘ |
| 25: | 10.8 | ↘ |
| 26: | 10.5 | ↘ |
| 27: | 10.6 | ↘ |
| 28: | 10.7 | ↘ |
| 29: | 9.7 | ← |
| 30: | 9.9 | ← |
| Serie | | 97.0 |
| Total | | 684.0 |

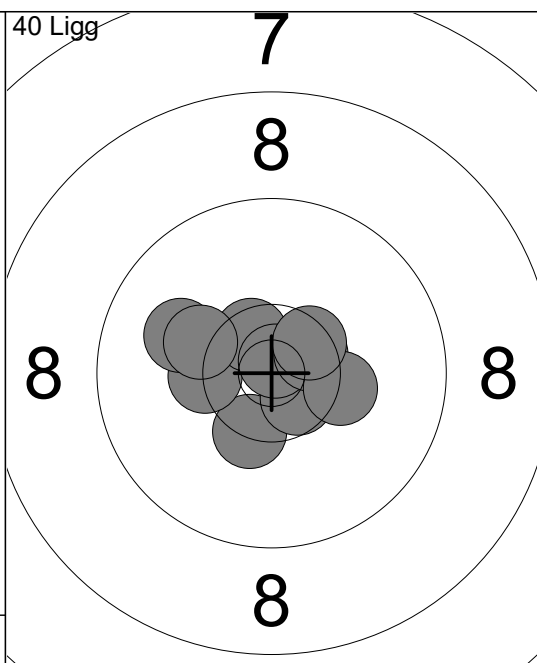

| | | |
|-------|------|-------|
| 31: | 10.4 | ↘ |
| 32: | 10.3 | ↘ |
| 33: | 10.6 | ↘ |
| 34: | 10.0 | ↘ |
| 35: | 10.5 | ↘ |
| 36: | 10.8 | ↗ |
| 37: | 10.2 | ↖ |
| 38: | 10.5 | ↗ |
| 39: | 10.3 | → |
| 40: | 10.5 | ↗ |
| Serie | | 100.0 |
| Total | | 784.0 |

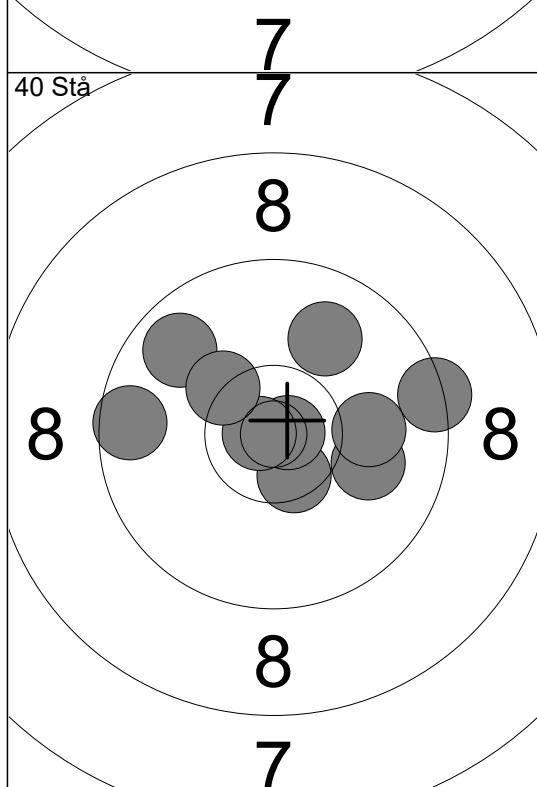

| | | |
|-------|------|-------|
| 1: | 9.8 | ↖ |
| 2: | 10.0 | → |
| 3: | 9.9 | ↗ |
| 4: | 9.4 | → |
| 5: | 10.5 | ↘ |
| 6: | 9.6 | ← |
| 7: | 10.0 | → |
| 8: | 10.8 | ↘ |
| 9: | 10.8 | ↘ |
| 10: | 10.3 | ↘ |
| Serie | | 96.0 |
| Total | | 880.0 |

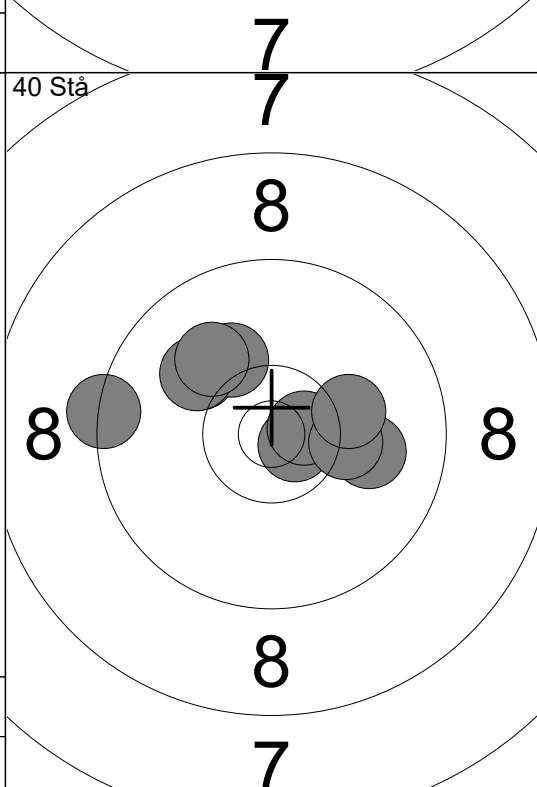

| | | |
|-------|------|-------|
| 11: | 10.7 | ↘ |
| 12: | 10.1 | ↖ |
| 13: | 10.6 | ↘ |
| 14: | 9.4 | ← |
| 15: | 10.2 | ↖ |
| 16: | 10.0 | ↖ |
| 17: | 10.0 | → |
| 18: | 10.2 | → |
| 19: | 10.2 | → |
| 20: | 10.0 | ↖ |
| Serie | | 99.0 |
| Total | | 979.0 |

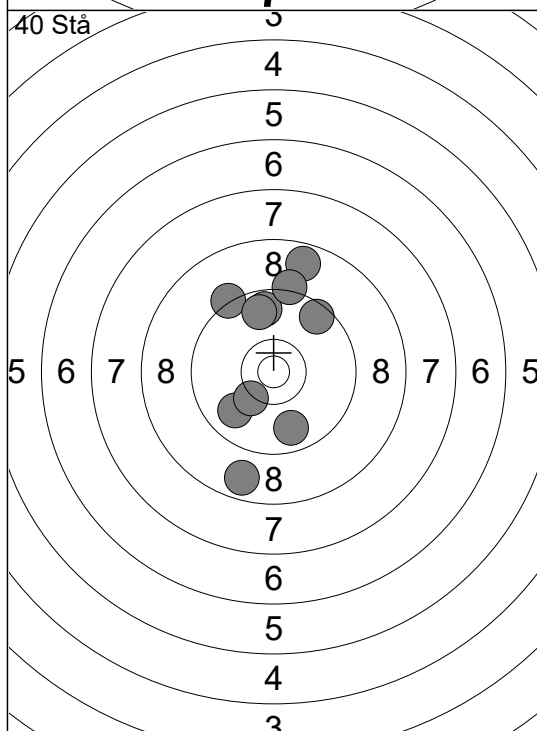

| | | |
|-------|------|--------|
| 21: | 9.6 | ↗ |
| 22: | 9.8 | ↖ |
| 23: | 8.7 | ↗ |
| 24: | 8.7 | ↘ |
| 25: | 9.7 | ↗ |
| 26: | 9.2 | ↗ |
| 27: | 9.3 | ↖ |
| 28: | 9.7 | ↗ |
| 29: | 9.8 | ↘ |
| 30: | 10.3 | ↘ |
| Serie | | 89.0 |
| Total | | 1068.0 |

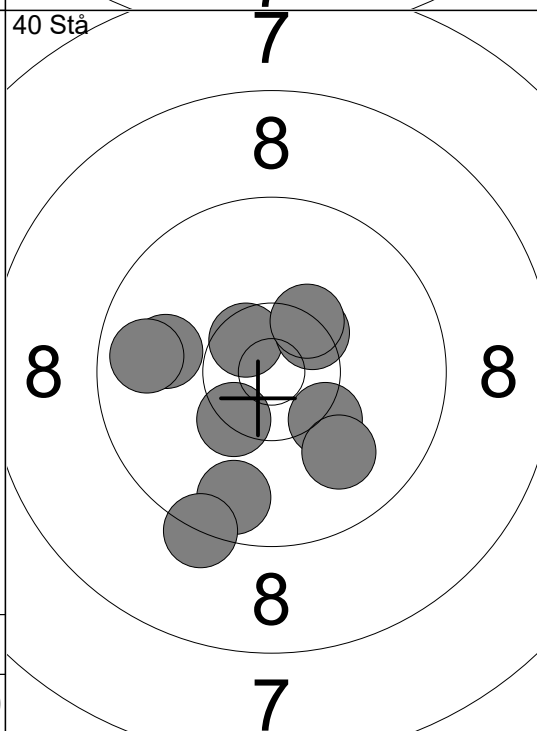

| | | |
|-------|------|--------|
| 31: | 10.4 | ↘ |
| 32: | 10.6 | ↘ |
| 33: | 9.9 | ← |
| 34: | 9.7 | ↓ |
| 35: | 9.8 | ← |
| 36: | 10.3 | ↘ |
| 37: | 10.0 | ↘ |
| 38: | 10.4 | ↗ |
| 39: | 9.3 | ↓ |
| 40: | 10.4 | ↗ |
| Serie | | 96.0 |
| Total | | 1164.0 |

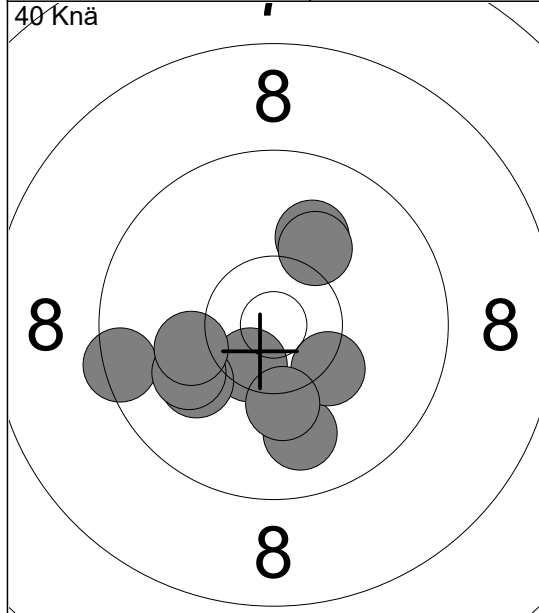

| | | |
|-------|------|------|
| 1: | 9.5 | ← |
| 2: | 10.5 | ↘ |
| 3: | 9.9 | ↓ |
| 4: | 10.0 | ↗ |
| 5: | 10.0 | ↙ |
| 6: | 10.1 | ↗ |
| 7: | 10.0 | ↙ |
| 8: | 10.3 | ↘ |
| 9: | 10.1 | ← |
| 10: | 10.2 | ↓ |
| Serie | | 98.0 |
| Total | | 98.0 |

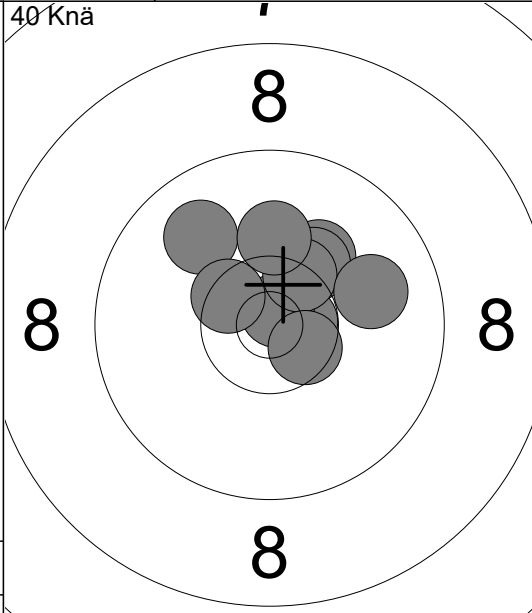

| | | |
|-------|------|-------|
| 11: | 9.9 | ↖ |
| 12: | 10.2 | ↗ |
| 13: | 10.2 | ↗ |
| 14: | 10.7 | ↘ |
| 15: | 10.8 | ↗ |
| 16: | 10.4 | ↗ |
| 17: | 10.6 | ↘ |
| 18: | 10.1 | ↑ |
| 19: | 9.9 | → |
| 20: | 10.5 | ↘ |
| Serie | | 98.0 |
| Total | | 196.0 |

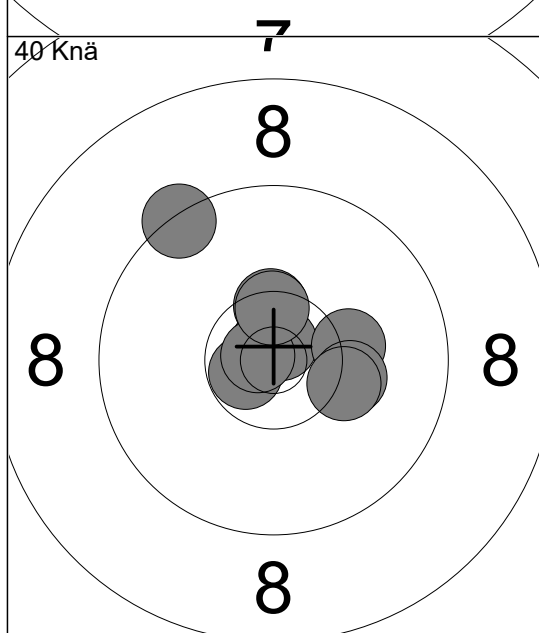

| | | |
|-------|------|-------|
| 21: | 10.8 | ↘ |
| 22: | 10.7 | ↘ |
| 23: | 10.8 | ↗ |
| 24: | 10.4 | ↗ |
| 25: | 10.8 | ↘ |
| 26: | 10.2 | → |
| 27: | 10.5 | ↗ |
| 28: | 10.2 | → |
| 29: | 9.4 | ↖ |
| 30: | 10.3 | → |
| Serie | | 99.0 |
| Total | | 295.0 |

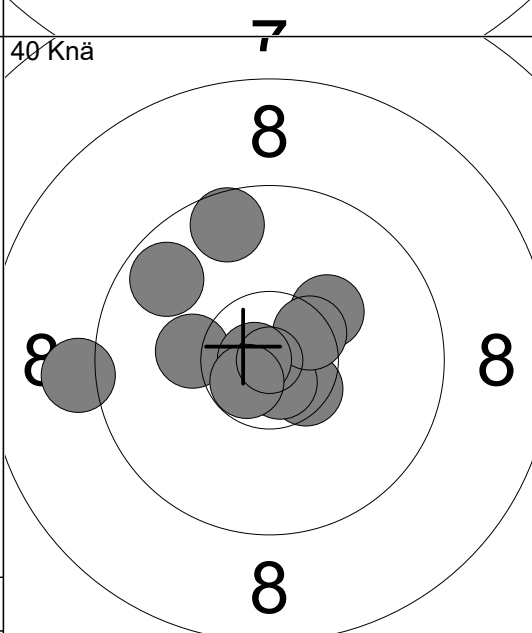

| | | |
|-------|------|-------|
| 31: | 9.7 | ↖ |
| 32: | 10.2 | ↗ |
| 33: | 10.5 | ↘ |
| 34: | 9.1 | ← |
| 35: | 10.7 | ↘ |
| 36: | 9.6 | ↑ |
| 37: | 10.5 | ↗ |
| 38: | 10.2 | ← |
| 39: | 10.8 | ↘ |
| 40: | 10.7 | ↘ |
| Serie | | 97.0 |
| Total | | 392.0 |

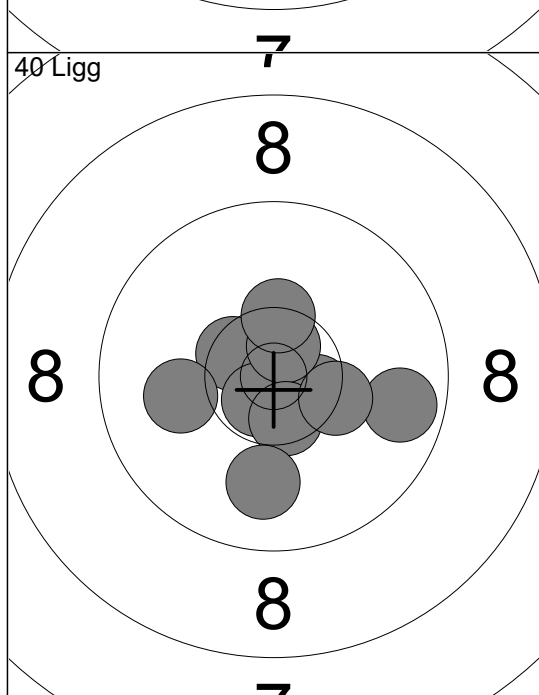

| | | |
|-------|------|-------|
| 1: | 10.5 | ↘ |
| 2: | 9.7 | → |
| 3: | 10.5 | ↘ |
| 4: | 10.7 | ↘ |
| 5: | 10.7 | ↗ |
| 6: | 10.5 | ↘ |
| 7: | 10.4 | ↗ |
| 8: | 10.3 | ↘ |
| 9: | 9.9 | ↓ |
| 10: | 10.1 | ← |
| Serie | | 98.0 |
| Total | | 490.0 |

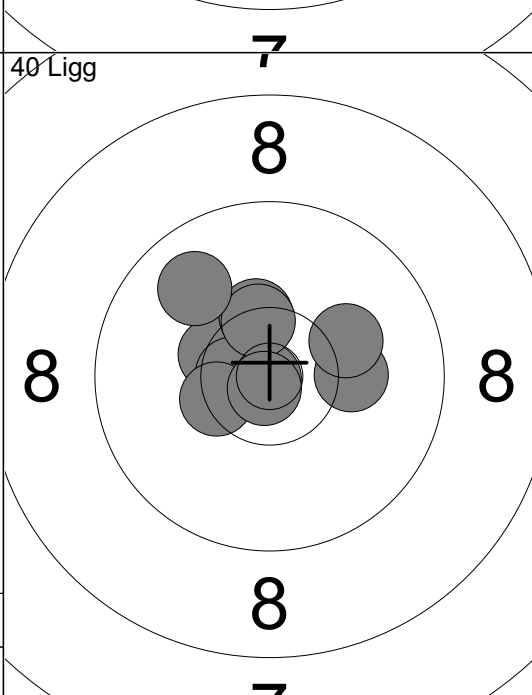

| | | |
|-------|------|-------|
| 11: | 10.9 | ↘ |
| 12: | 10.4 | ↘ |
| 13: | 10.6 | ↘ |
| 14: | 10.2 | → |
| 15: | 10.4 | ↗ |
| 16: | 10.4 | ↘ |
| 17: | 10.4 | ↗ |
| 18: | 9.9 | ↖ |
| 19: | 10.8 | ↘ |
| 20: | 10.2 | ↗ |
| Serie | | 99.0 |
| Total | | 589.0 |

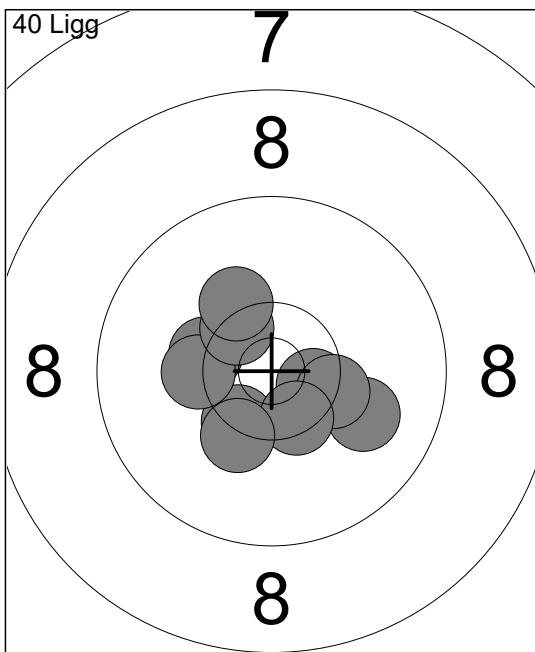

| | |
|-------|-------|
| 21: | 10.3x |
| 22: | 10.4x |
| 23: | 10.0 |
| 24: | 10.5x |
| 25: | 10.3x |
| 26: | 10.3 |
| 27: | 10.4x |
| 28: | 10.4x |
| 29: | 10.2 |
| 30: | 10.3 |
| Serie | 100.0 |
| Total | 689.0 |

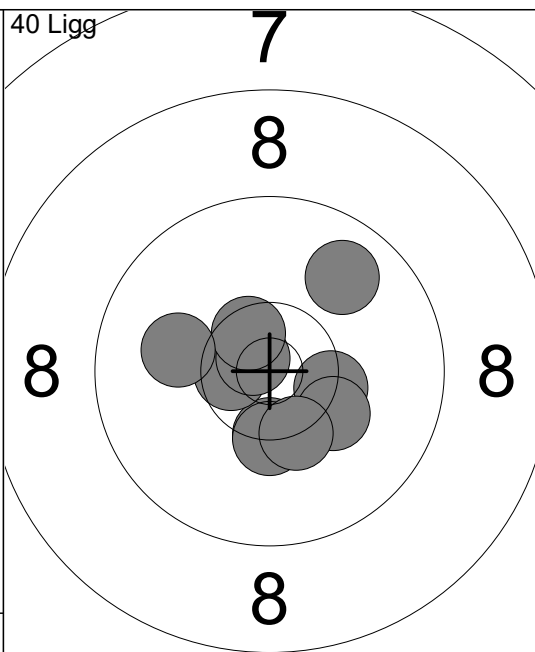

| | |
|-------|-------|
| 31: | 10.4x |
| 32: | 10.2 |
| 33: | 10.3x |
| 34: | 10.6x |
| 35: | 10.3x |
| 36: | 10.8x |
| 37: | 10.5x |
| 38: | 10.1 |
| 39: | 9.8 |
| 40: | 10.3x |
| Serie | 99.0 |
| Total | 788.0 |

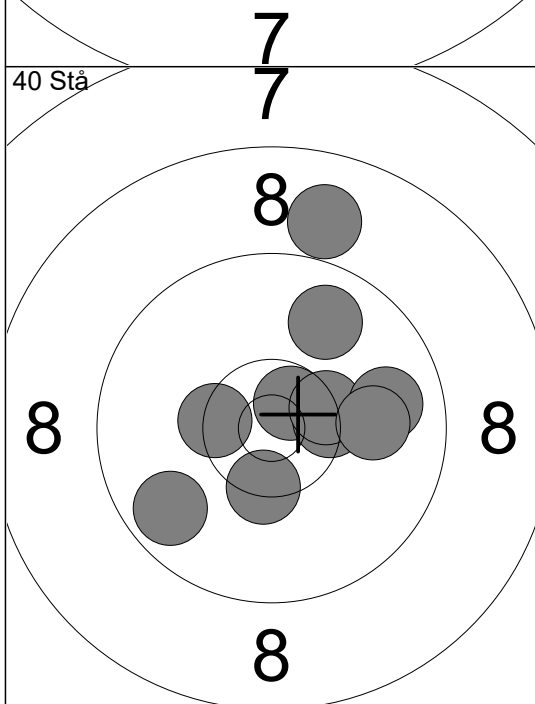

| | |
|-------|-------|
| 1: | 10.4x |
| 2: | 10.7x |
| 3: | 10.4x |
| 4: | 10.4x |
| 5: | 9.8 |
| 6: | 9.7 |
| 7: | 10.4x |
| 8: | 8.9 |
| 9: | 10.0 |
| 10: | 9.8 |
| Serie | 95.0 |
| Total | 883.0 |

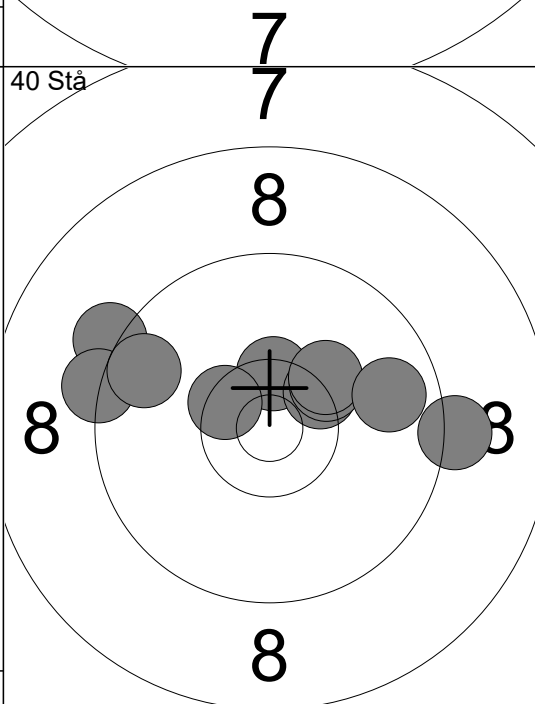

| | |
|-------|-------|
| 11: | 10.4x |
| 12: | 10.5x |
| 13: | 10.4x |
| 14: | 9.2 |
| 15: | 9.2 |
| 16: | 10.3 |
| 17: | 9.3 |
| 18: | 10.2 |
| 19: | 9.6 |
| 20: | 9.8 |
| Serie | 95.0 |
| Total | 978.0 |

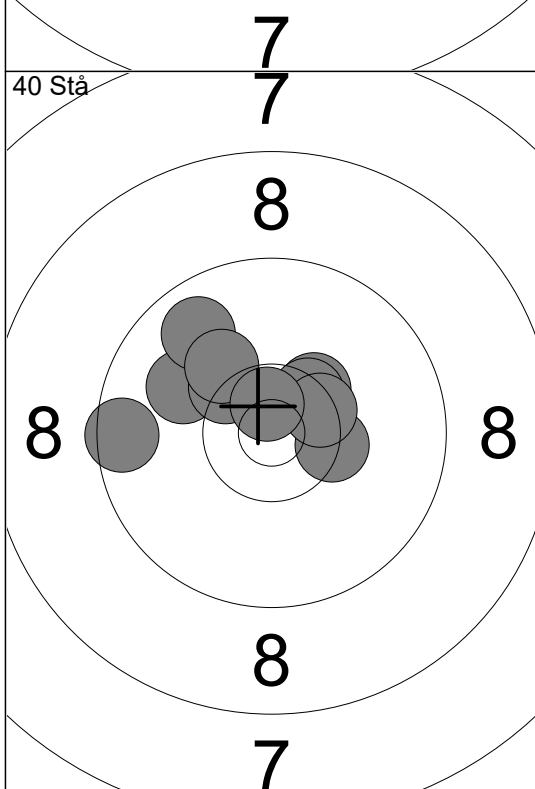

| | |
|-------|--------|
| 21: | 10.4x |
| 22: | 10.4x |
| 23: | 10.5x |
| 24: | 10.0 |
| 25: | 10.4x |
| 26: | 9.5 |
| 27: | 9.8 |
| 28: | 10.3x |
| 29: | 10.2 |
| 30: | 10.7x |
| Serie | 98.0 |
| Total | 1076.0 |

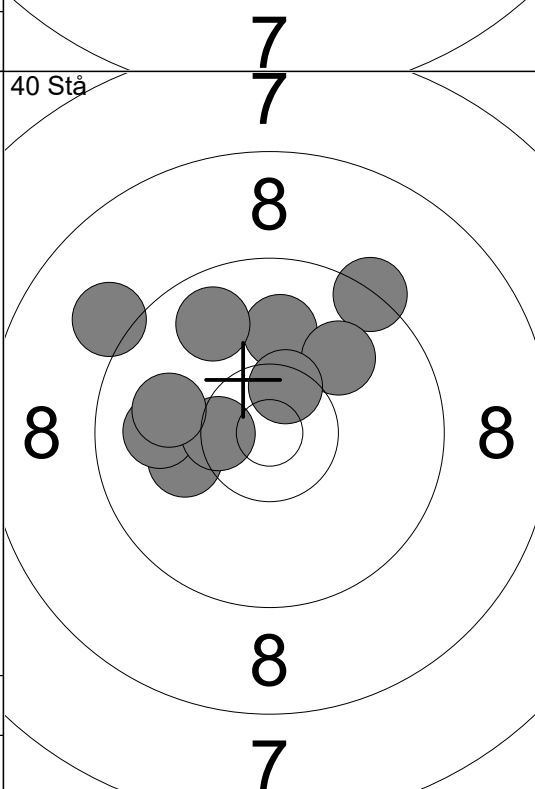

| | |
|-------|--------|
| 31: | 10.1 |
| 32: | 10.0 |
| 33: | 9.3 |
| 34: | 9.8 |
| 35: | 9.1 |
| 36: | 9.9 |
| 37: | 10.5x |
| 38: | 10.0 |
| 39: | 10.0 |
| 40: | 10.5x |
| Serie | 96.0 |
| Total | 1172.0 |

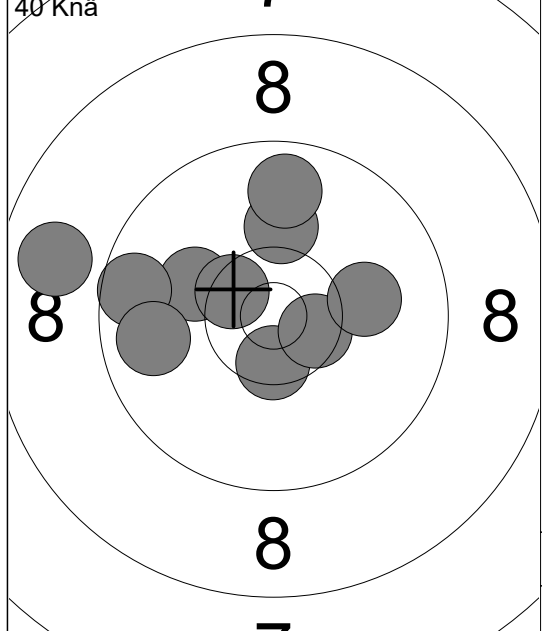

| | | |
|-------|------|------|
| 1: | 8.8 | ← |
| 2: | 10.1 | ↑ |
| 3: | 10.1 | ← |
| 4: | 10.5 | ↘ |
| 5: | 10.5 | ↓ |
| 6: | 9.8 | ↑ |
| 7: | 9.6 | ← |
| 8: | 10.5 | → |
| 9: | 10.1 | → |
| 10: | 9.8 | ← |
| Serie | | 95.0 |
| Total | | 95.0 |

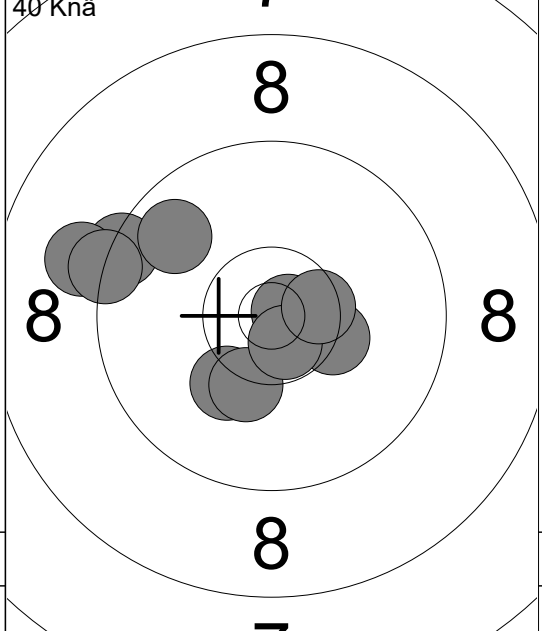

| | | |
|-------|------|-------|
| 11: | 10.3 | → |
| 12: | 10.2 | ↙ |
| 13: | 9.4 | ← |
| 14: | 10.3 | ↓ |
| 15: | 9.8 | ↖ |
| 16: | 9.1 | ← |
| 17: | 10.8 | → |
| 18: | 9.3 | ← |
| 19: | 10.7 | ↘ |
| 20: | 10.5 | → |
| Serie | | 96.0 |
| Total | | 191.0 |

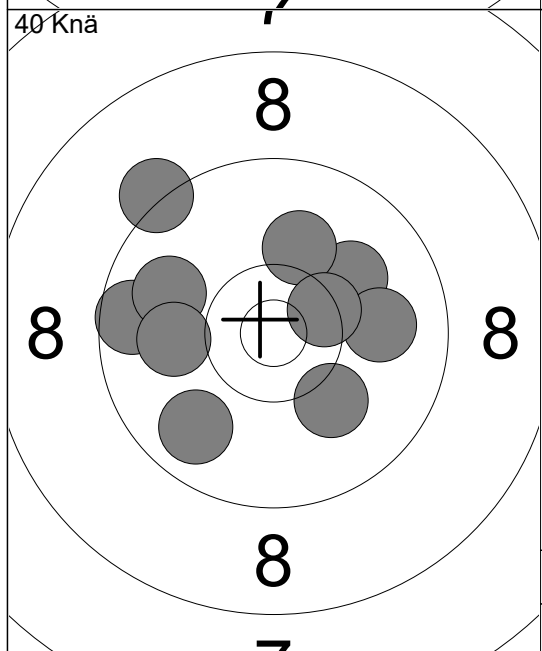

| | | |
|-------|------|-------|
| 21: | 10.1 | ↗ |
| 22: | 9.9 | → |
| 23: | 9.6 | ← |
| 24: | 9.9 | ← |
| 25: | 10.0 | ← |
| 26: | 9.2 | ↖ |
| 27: | 10.1 | ↑ |
| 28: | 10.1 | ↘ |
| 29: | 9.8 | ↙ |
| 30: | 10.4 | ↗ |
| Serie | | 95.0 |
| Total | | 286.0 |

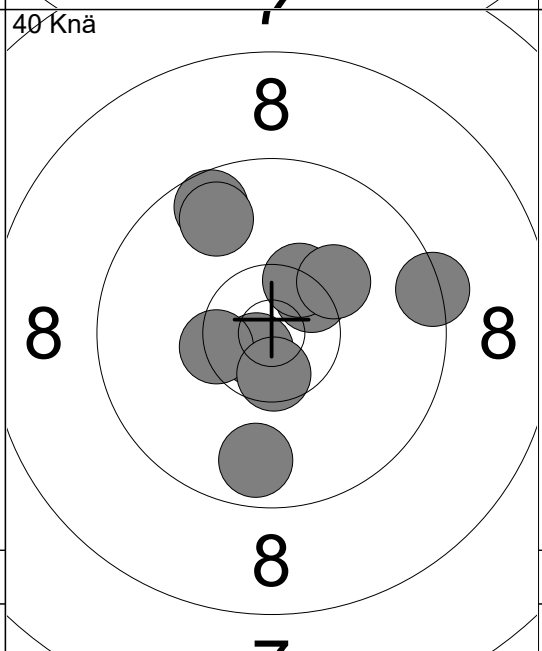

| | | |
|-------|------|-------|
| 31: | 10.4 | ↗ |
| 32: | 10.7 | ↘ |
| 33: | 10.4 | ↗ |
| 34: | 9.6 | ↖ |
| 35: | 9.8 | ↖ |
| 36: | 9.4 | → |
| 37: | 10.4 | ↖ |
| 38: | 10.6 | ↓ |
| 39: | 10.2 | ↗ |
| 40: | 9.7 | ↓ |
| Serie | | 96.0 |
| Total | | 382.0 |

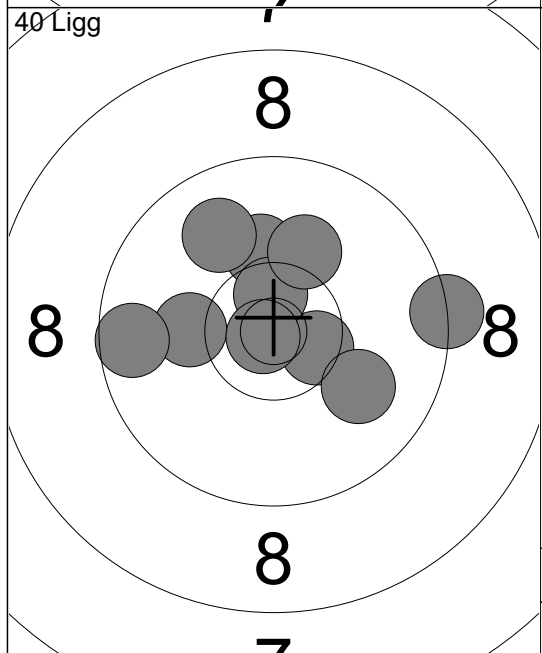

| | | |
|-------|------|-------|
| 1: | 10.2 | ↑ |
| 2: | 10.5 | → |
| 3: | 10.2 | ← |
| 4: | 9.6 | ← |
| 5: | 10.6 | ↑ |
| 6: | 9.9 | ↖ |
| 7: | 9.3 | → |
| 8: | 10.8 | ↖ |
| 9: | 10.1 | ↑ |
| 10: | 10.0 | ↘ |
| Serie | | 97.0 |
| Total | | 479.0 |

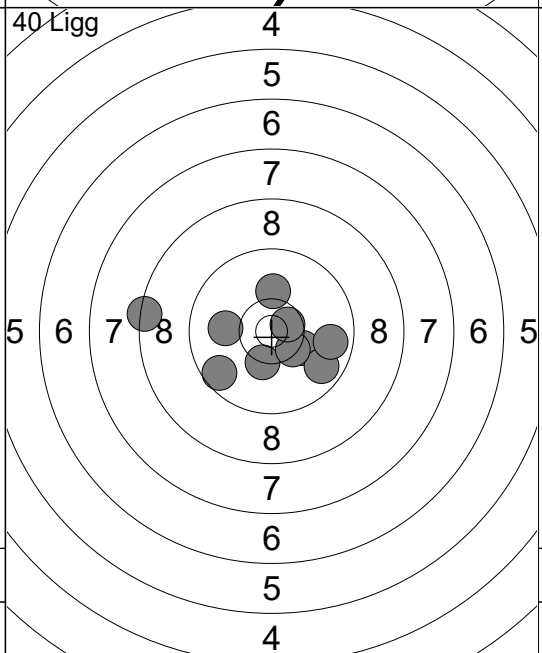

| | | |
|-------|------|-------|
| 11: | 10.0 | ← |
| 12: | 10.3 | → |
| 13: | 8.4 | ← |
| 14: | 9.6 | ↙ |
| 15: | 10.3 | ↘ |
| 16: | 9.7 | ↘ |
| 17: | 10.4 | ↘ |
| 18: | 10.6 | ↗ |
| 19: | 10.1 | ↑ |
| 20: | 9.7 | → |
| Serie | | 95.0 |
| Total | | 574.0 |

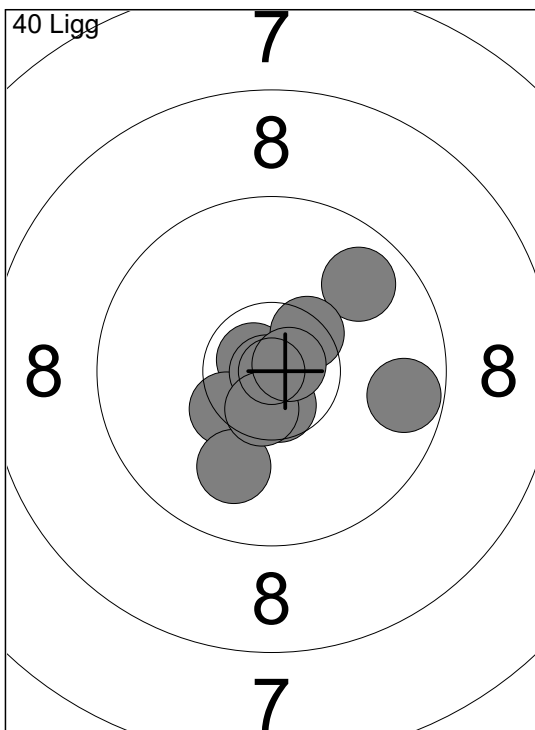

| | |
|-------|-------|
| 21: | 10.7x |
| 22: | 10.6x |
| 23: | 9.8 |
| 24: | 10.4x |
| 25: | 9.7 |
| 26: | 10.0 |
| 27: | 10.5x |
| 28: | 10.9x |
| 29: | 10.6x |
| 30: | 10.8x |
| Serie | 98.0 |
| Total | 672.0 |

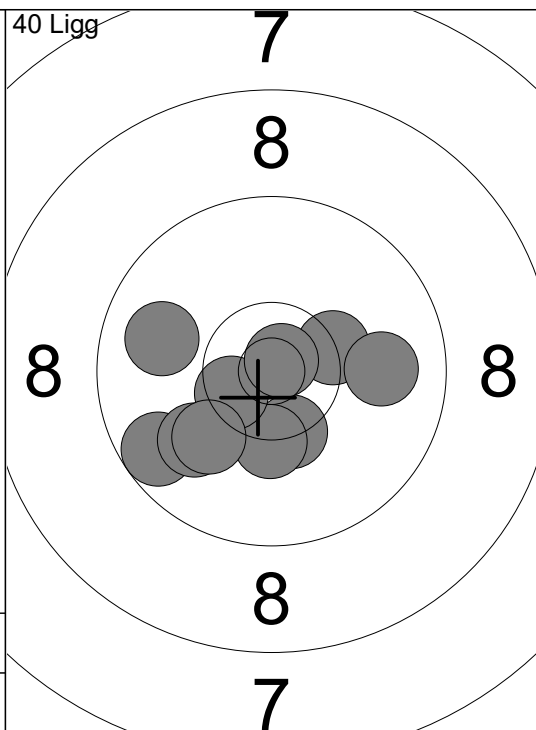

| | |
|-------|-------|
| 31: | 10.3x |
| 32: | 10.4x |
| 33: | 10.3 |
| 34: | 9.7 |
| 35: | 10.0 |
| 36: | 9.9 |
| 37: | 10.5x |
| 38: | 10.8x |
| 39: | 10.1 |
| 40: | 9.9 |
| Serie | 97.0 |
| Total | 769.0 |

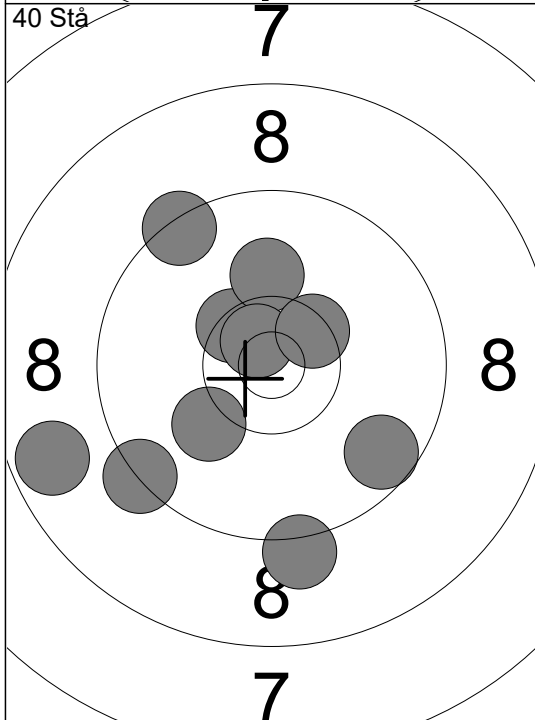

| | |
|-------|-------|
| 1: | 10.4x |
| 2: | 10.1 |
| 3: | 8.7 |
| 4: | 9.3 |
| 5: | 9.4 |
| 6: | 9.6 |
| 7: | 10.1 |
| 8: | 10.7x |
| 9: | 10.4x |
| 10: | 9.2 |
| Serie | 94.0 |
| Total | 863.0 |

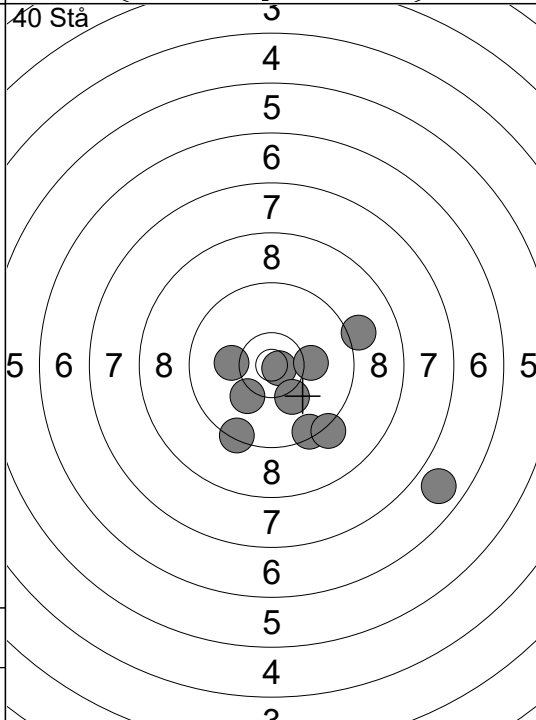

| | |
|-------|-------|
| 11: | 9.4 |
| 12: | 9.1 |
| 13: | 10.8x |
| 14: | 10.1 |
| 15: | 10.2 |
| 16: | 6.8 |
| 17: | 10.2 |
| 18: | 9.4 |
| 19: | 10.2 |
| 20: | 9.2 |
| Serie | 92.0 |
| Total | 955.0 |

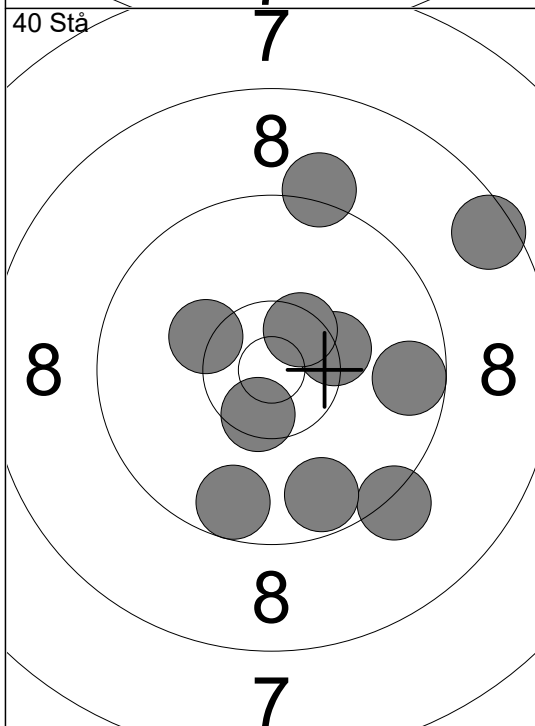

| | |
|-------|--------|
| 21: | 9.7 |
| 22: | 9.2 |
| 23: | 9.7 |
| 24: | 10.3 |
| 25: | 10.3x |
| 26: | 9.2 |
| 27: | 10.5x |
| 28: | 8.5 |
| 29: | 10.5x |
| 30: | 9.7 |
| Serie | 93.0 |
| Total | 1048.0 |

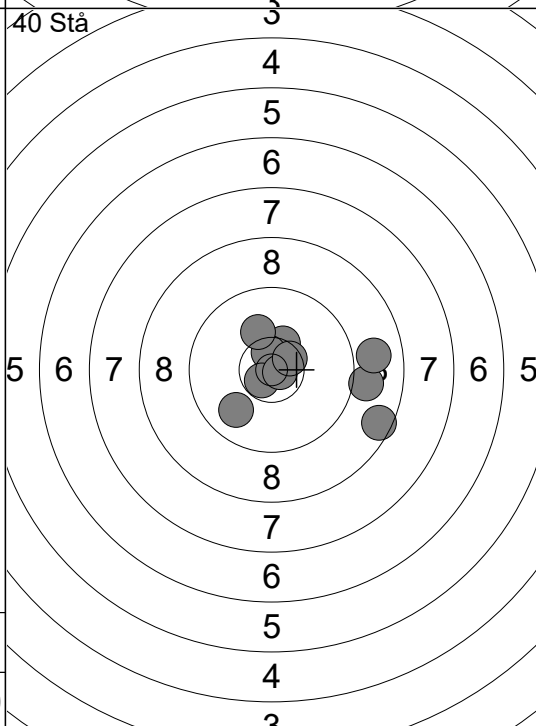

| | |
|-------|--------|
| 31: | 10.4x |
| 32: | 9.0 |
| 33: | 8.9 |
| 34: | 8.5 |
| 35: | 10.6x |
| 36: | 9.9 |
| 37: | 10.7x |
| 38: | 10.1 |
| 39: | 10.8x |
| 40: | 10.5x |
| Serie | 94.0 |
| Total | 1142.0 |

| | | | |
|---------------|---|---------------|--|
| <p>40 Knä</p> | <p>1: 9.8 ↘ 2: 10.5x↘ 3: 10.1 ↗ 4: 9.4 ↑ 5: 10.5x↗ 6: 10.1 ← 7: 9.8 ↗ 8: 10.0 ↓ 9: 10.1 ↗ 10: 10.7x↑</p> <p>Serie 97.0 Total 97.0</p> | <p>40 Knä</p> | <p>11: 10.9x↘ 12: 10.8x↘ 13: 9.7 ↘ 14: 10.9x↘ 15: 10.2 ↗ 16: 9.6 ↑ 17: 9.7 ↗ 18: 10.0 ↑ 19: 9.7 ↑ 20: 10.6x↘</p> <p>Serie 96.0 Total 193.0</p> |
|---------------|---|---------------|--|

| | | | |
|---------------|--|---------------|--|
| <p>40 Knä</p> | <p>21: 9.9 ↓ 22: 9.5 ↓ 23: 9.7 ← 24: 10.6x→ 25: 10.0 ↓ 26: 10.2 → 27: 9.8 ← 28: 10.4x↘ 29: 10.3 → 30: 10.8x↗</p> <p>Serie 96.0 Total 289.0</p> | <p>40 Knä</p> | <p>31: 9.4 ↗ 32: 10.4x↘ 33: 9.9 ↗ 34: 10.5x↘ 35: 10.5x→ 36: 10.2 ↑ 37: 10.4x↗ 38: 10.1 ↗ 39: 9.5 → 40: 9.9 ↗</p> <p>Serie 96.0 Total 385.0</p> |
|---------------|--|---------------|--|

| | | | |
|----------------|---|----------------|--|
| <p>40 Ligg</p> | <p>1: 10.1 ↗ 2: 10.1 → 3: 9.5 → 4: 10.6x↘ 5: 10.0 ← 6: 10.7x↗ 7: 10.9x↘ 8: 10.1 ↗ 9: 10.4x↘ 10: 9.5 →</p> <p>Serie 98.0 Total 483.0</p> | <p>40 Ligg</p> | <p>11: 10.3x↑ 12: 9.7 ↑ 13: 10.6x↘ 14: 9.7 → 15: 10.5x↑ 16: 10.0 → 17: 10.6x→ 18: 10.2 ↗ 19: 10.3x↘ 20: 10.3 ↗</p> <p>Serie 98.0 Total 581.0</p> |
|----------------|---|----------------|--|

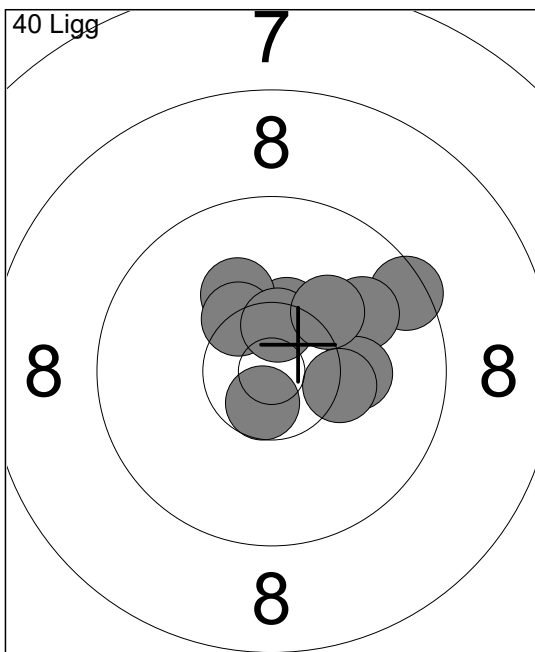

- 21: 10.4x ↗
- 22: 10.2 ↖
- 23: 10.4x ↘
- 24: 10.5x ↗
- 25: 9.5 ↗
- 26: 9.9 ↗
- 27: 10.2 →
- 28: 10.6x ↘
- 29: 10.2 ↗
- 30: 10.3x →

Serie 98.0
Total 679.0

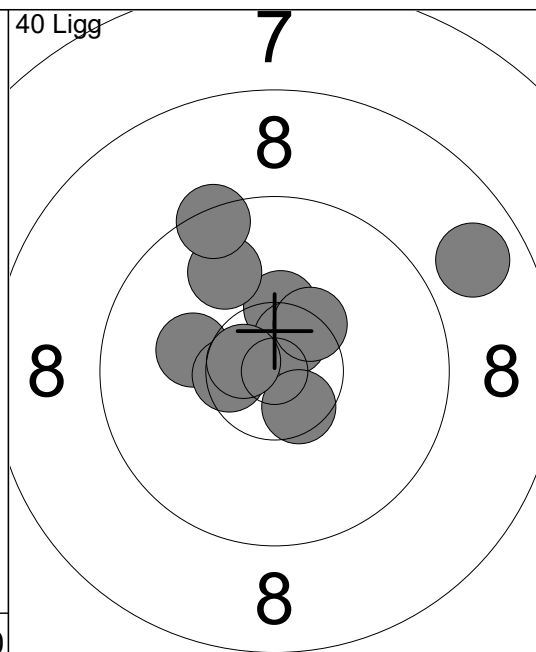

- 31: 10.3x ↗
- 32: 10.2 ↖
- 33: 10.5x ↘
- 34: 10.6x ↗
- 35: 10.4x ↗
- 36: 10.5x ↘
- 37: 10.6x ↘
- 38: 8.8 ↗
- 39: 9.9 ↖
- 40: 9.4 ↖

Serie 96.0
Total 775.0

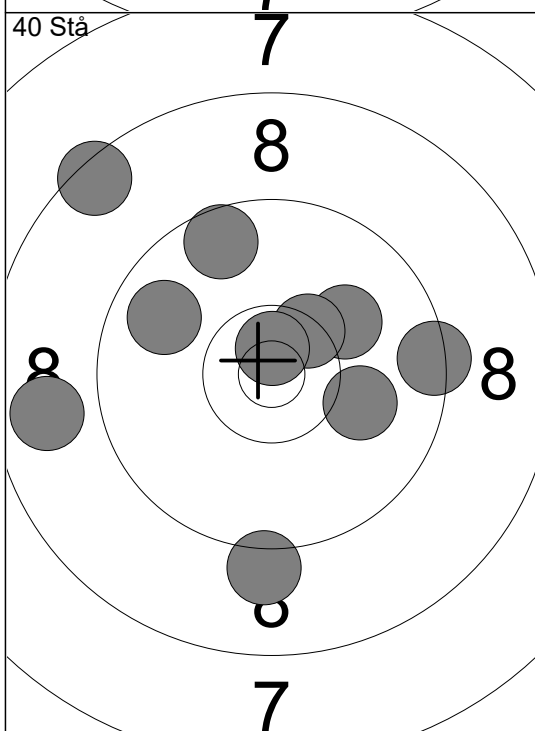

- 1: 10.1 ↗
- 2: 9.1 ↓
- 3: 10.4x ↗
- 4: 9.8 ↖
- 5: 8.8 ←
- 6: 9.4 →
- 7: 10.7x ↗
- 8: 10.1 →
- 9: 8.5 ↖
- 10: 9.6 ↖

Serie 92.0
Total 867.0

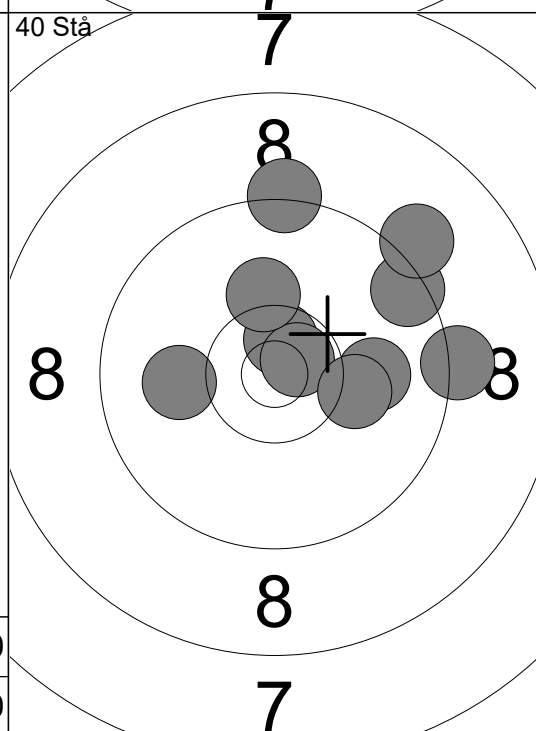

- 11: 10.6x ↗
- 12: 10.0 →
- 13: 10.7x ↗
- 14: 10.2 ↑
- 15: 9.5 ↗
- 16: 10.2 →
- 17: 9.1 ↗
- 18: 9.3 ↑
- 19: 9.2 →
- 20: 10.1 ←

Serie 96.0
Total 963.0

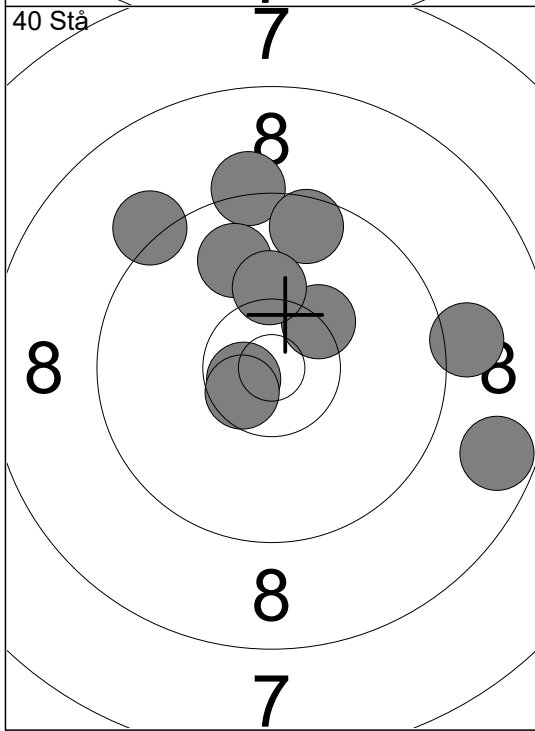

- 21: 10.7x ↘
- 22: 9.2 ↑
- 23: 9.2 ↖
- 24: 10.6x ↘
- 25: 9.9 ↖
- 26: 10.3x ↗
- 27: 8.7 →
- 28: 9.6 ↑
- 29: 10.2 ↑
- 30: 9.1 →

Serie 93.0
Total 1056.0

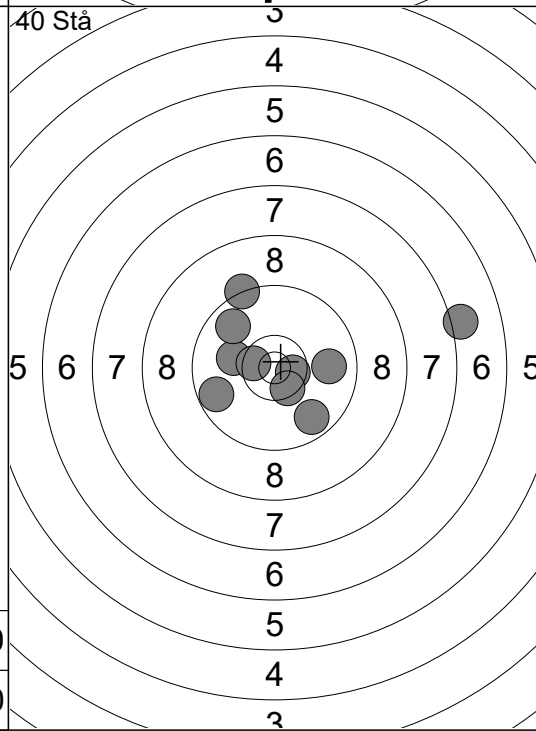

- 31: 10.1 ←
- 32: 10.6x →
- 33: 9.9 →
- 34: 7.1 →
- 35: 9.7 ←
- 36: 9.8 ↖
- 37: 10.5x ↘
- 38: 9.7 ↘
- 39: 9.3 ↖
- 40: 10.5x ↘

Serie 92.0
Total 1148.0

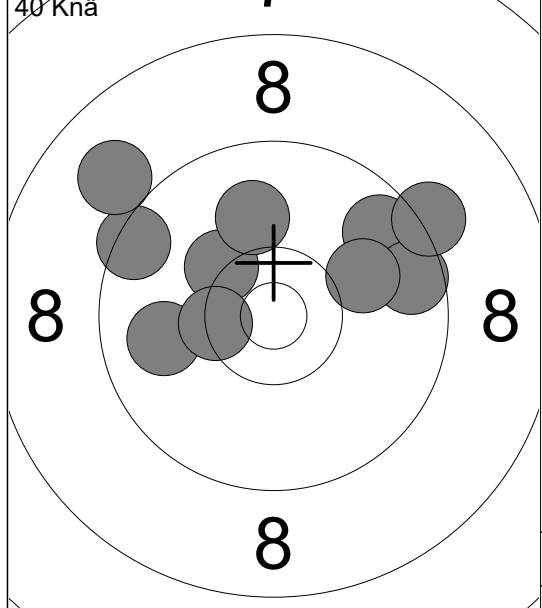

| | | |
|-------|------|------|
| 1: | 9.7 | ↗ |
| 2: | 9.5 | ↖ |
| 3: | 9.0 | ↖ |
| 4: | 9.6 | → |
| 5: | 9.2 | ↗ |
| 6: | 9.9 | ← |
| 7: | 10.3 | ↖ |
| 8: | 10.0 | ↗ |
| 9: | 10.4 | ↖ |
| 10: | 10.0 | ↑ |
| Serie | | 94.0 |
| Total | | 94.0 |

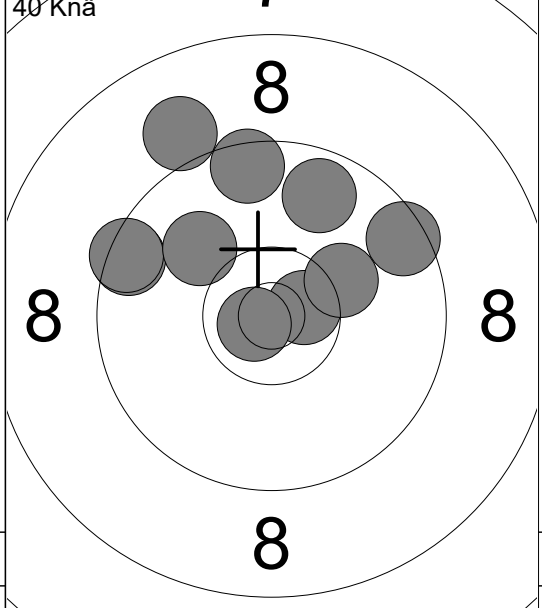

| | | |
|-------|------|-------|
| 11: | 9.5 | ↖ |
| 12: | 9.0 | ↖ |
| 13: | 9.5 | ↖ |
| 14: | 9.5 | ↗ |
| 15: | 10.6 | ↗ |
| 16: | 10.8 | ↖ |
| 17: | 10.2 | ↗ |
| 18: | 10.0 | ↖ |
| 19: | 9.5 | ↑ |
| 20: | 9.7 | ↑ |
| Serie | | 94.0 |
| Total | | 188.0 |

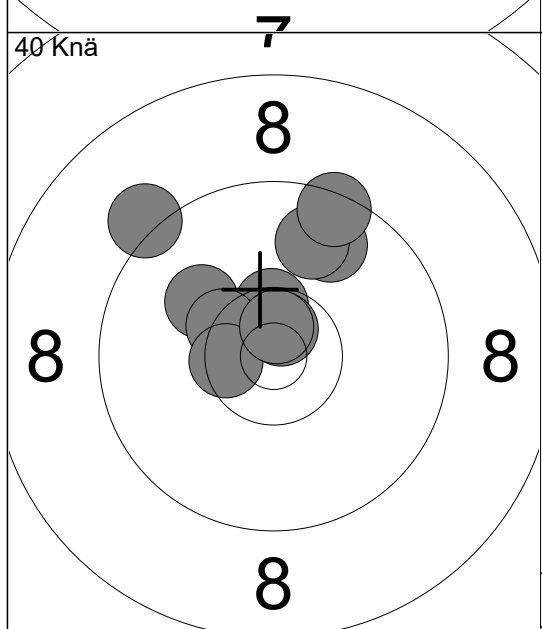

| | | |
|-------|------|-------|
| 21: | 10.1 | ↖ |
| 22: | 9.2 | ↖ |
| 23: | 10.5 | ↗ |
| 24: | 10.4 | ↖ |
| 25: | 9.8 | ↗ |
| 26: | 10.5 | ↖ |
| 27: | 10.7 | ↗ |
| 28: | 9.8 | ↗ |
| 29: | 9.5 | ↗ |
| 30: | 10.7 | ↗ |
| Serie | | 96.0 |
| Total | | 284.0 |

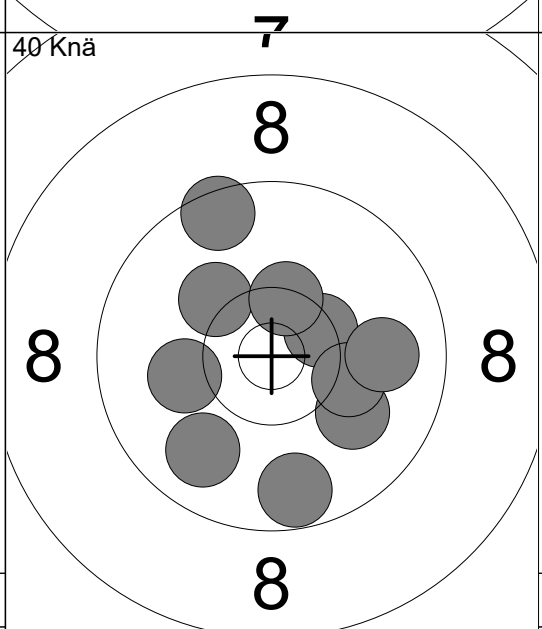

| | | |
|-------|------|-------|
| 31: | 9.5 | ↑ |
| 32: | 10.4 | ↗ |
| 33: | 10.2 | ↖ |
| 34: | 10.4 | ↗ |
| 35: | 9.7 | ↓ |
| 36: | 10.0 | ↘ |
| 37: | 10.2 | → |
| 38: | 10.1 | ← |
| 39: | 9.9 | ↘ |
| 40: | 9.9 | → |
| Serie | | 96.0 |
| Total | | 380.0 |

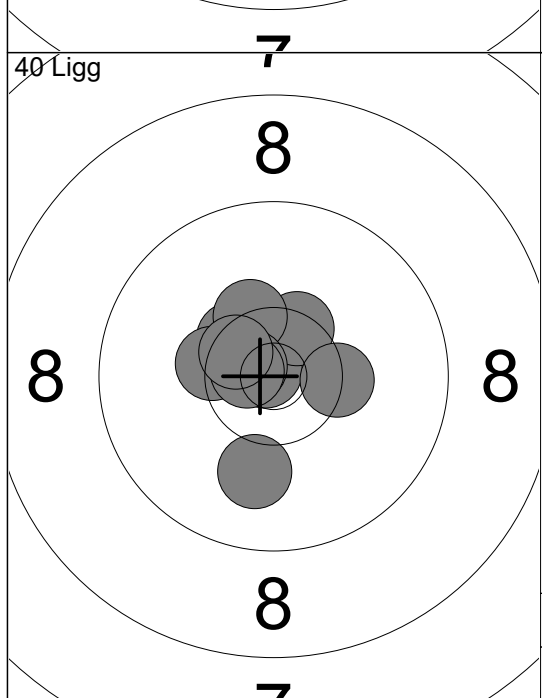

| | | |
|-------|------|-------|
| 1: | 10.9 | ↖ |
| 2: | 10.4 | ↗ |
| 3: | 10.3 | → |
| 4: | 10.4 | ↖ |
| 5: | 10.0 | ↓ |
| 6: | 10.3 | ↖ |
| 7: | 10.4 | ↖ |
| 8: | 10.7 | ↖ |
| 9: | 10.7 | ↖ |
| 10: | 10.5 | ↖ |
| Serie | | 100.0 |
| Total | | 480.0 |

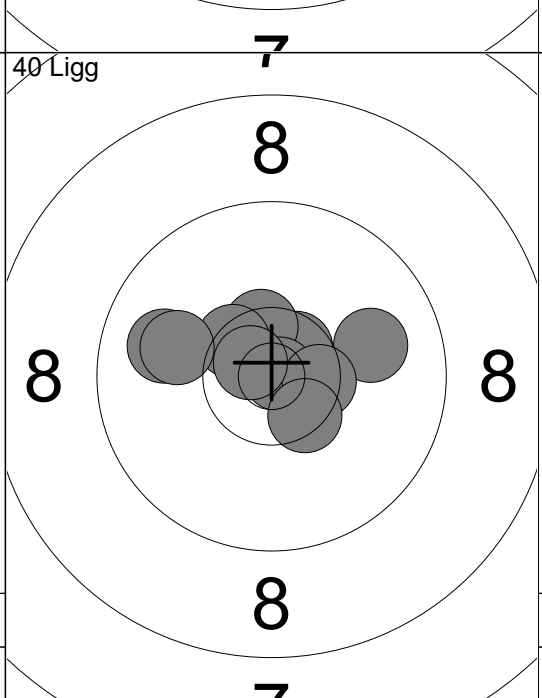

| | | |
|-------|------|-------|
| 11: | 10.0 | → |
| 12: | 10.6 | ↗ |
| 13: | 9.9 | ↖ |
| 14: | 10.5 | ↗ |
| 15: | 10.5 | ↖ |
| 16: | 10.0 | ↖ |
| 17: | 10.9 | ↗ |
| 18: | 10.5 | → |
| 19: | 10.5 | ↖ |
| 20: | 10.7 | ↖ |
| Serie | | 99.0 |
| Total | | 579.0 |

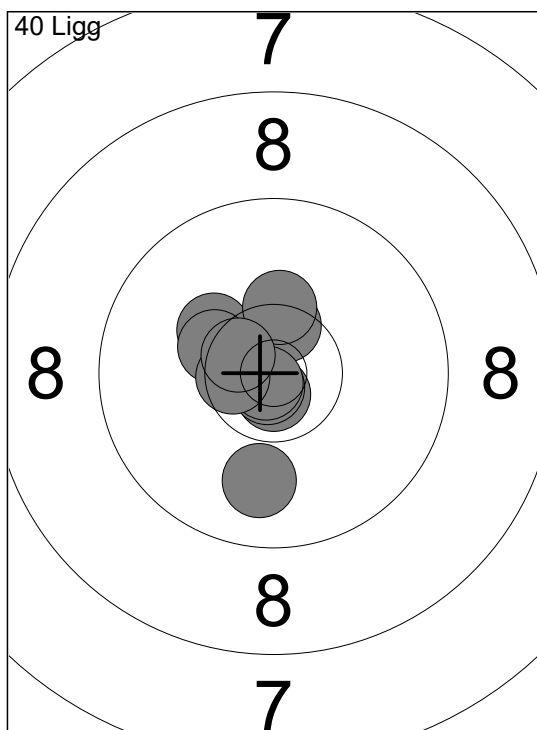

| | |
|-------------|---------|
| 21: | 10.3 ↗ |
| 22: | 10.8x ↓ |
| 23: | 10.8x ↓ |
| 24: | 10.5x ↗ |
| 25: | 10.3x ↗ |
| 26: | 10.8x ↓ |
| 27: | 10.6x ↗ |
| 28: | 9.9 ↓ |
| 29: | 10.3x ↗ |
| 30: | 10.6x ↗ |
| Serie 99.0 | |
| Total 678.0 | |

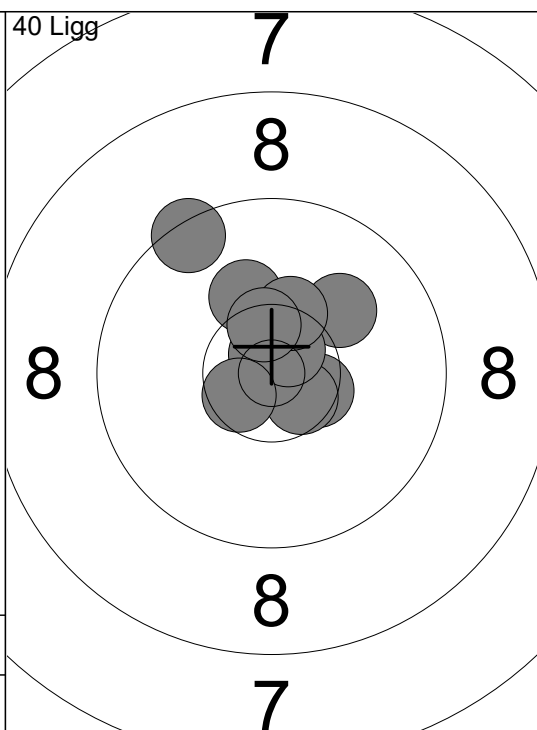

| | |
|-------------|---------|
| 31: | 10.1 ↗ |
| 32: | 10.5x ↗ |
| 33: | 10.2 ↗ |
| 34: | 10.8x ↗ |
| 35: | 10.6x ↗ |
| 36: | 10.7x ↗ |
| 37: | 10.6x ↗ |
| 38: | 10.4x ↗ |
| 39: | 10.5x ↗ |
| 40: | 9.4 ↗ |
| Serie 99.0 | |
| Total 777.0 | |

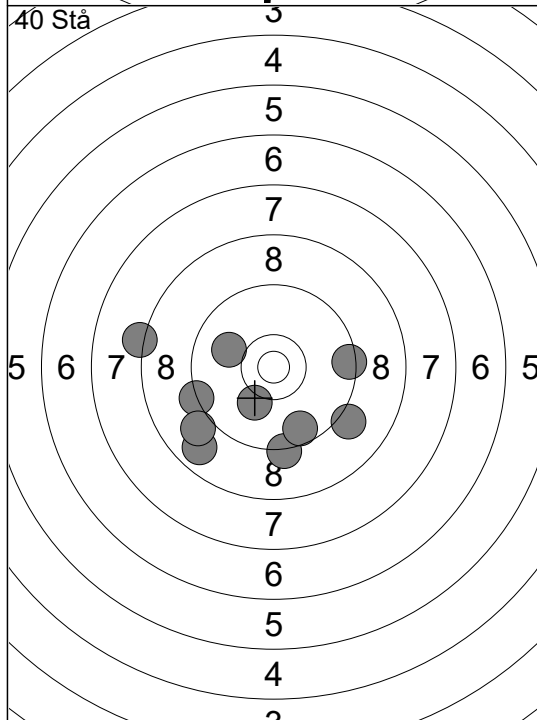

| | |
|-------------|--------|
| 1: | 8.8 ↙ |
| 2: | 8.2 ← |
| 3: | 9.4 → |
| 4: | 10.0 ↗ |
| 5: | 10.1 ↓ |
| 6: | 9.3 ← |
| 7: | 9.2 ↓ |
| 8: | 9.6 ↓ |
| 9: | 9.0 ↙ |
| 10: | 9.1 ↘ |
| Serie 90.0 | |
| Total 867.0 | |

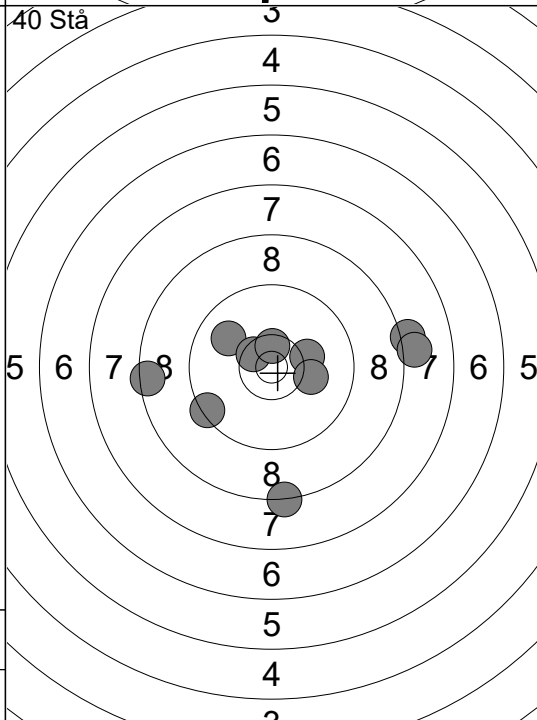

| | |
|-------------|---------|
| 11: | 9.4 ↙ |
| 12: | 9.9 ↙ |
| 13: | 10.2 → |
| 14: | 10.5x ↗ |
| 15: | 10.1 → |
| 16: | 8.2 → |
| 17: | 8.5 ← |
| 18: | 10.5x ↗ |
| 19: | 8.1 → |
| 20: | 8.3 ↓ |
| Serie 90.0 | |
| Total 957.0 | |

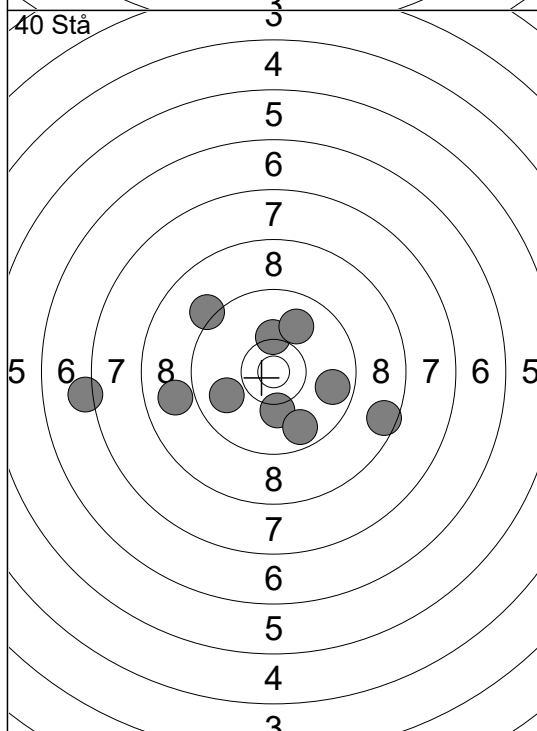

| | |
|--------------|--------|
| 21: | 7.2 ← |
| 22: | 8.9 ← |
| 23: | 9.2 ↙ |
| 24: | 10.2 ↓ |
| 25: | 8.5 → |
| 26: | 9.7 ↓ |
| 27: | 9.9 ↙ |
| 28: | 10.3 ↑ |
| 29: | 9.7 → |
| 30: | 9.9 ↗ |
| Serie 88.0 | |
| Total 1045.0 | |

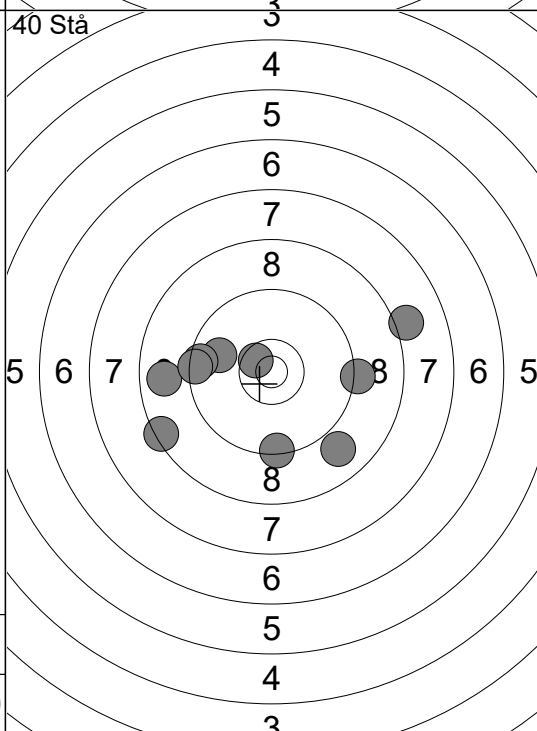

| | |
|--------------|---------|
| 31: | 9.9 ← |
| 32: | 9.2 → |
| 33: | 9.4 ↓ |
| 34: | 8.1 → |
| 35: | 8.4 ↙ |
| 36: | 9.5 ← |
| 37: | 8.8 ← |
| 38: | 8.9 ↓ |
| 39: | 10.6x ↗ |
| 40: | 9.4 ← |
| Serie 87.0 | |
| Total 1132.0 | |

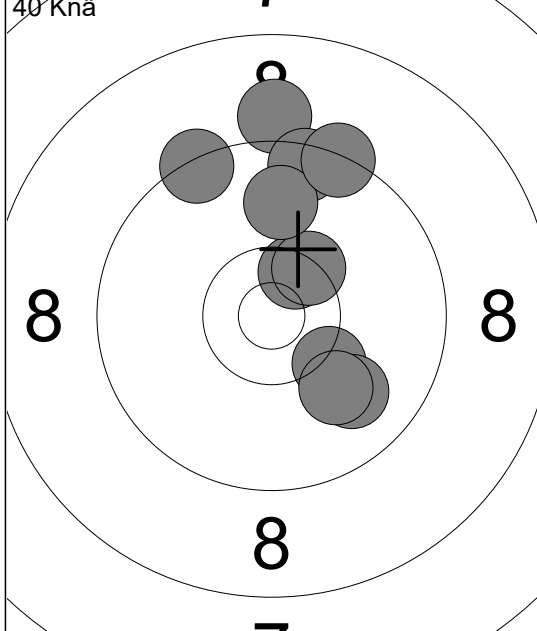

| | |
|------------|---------|
| 1: | 10.5x ↗ |
| 2: | 9.1 ↑ |
| 3: | 9.4 ↖ |
| 4: | 9.5 ↑ |
| 5: | 10.2 ↘ |
| 6: | 10.4x ↗ |
| 7: | 9.9 ↑ |
| 8: | 9.9 ↘ |
| 9: | 10.0 ↘ |
| 10: | 9.4 ↑ |
| Serie 94.0 | |
| Total 94.0 | |

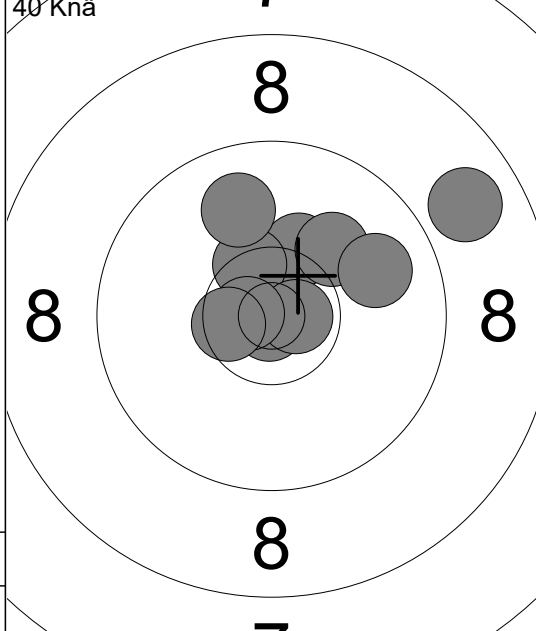

| | |
|-------------|---------|
| 11: | 10.9x ↘ |
| 12: | 10.3 ↗ |
| 13: | 10.4x ↖ |
| 14: | 10.7x ➔ |
| 15: | 10.7x ↙ |
| 16: | 8.8 ➔ |
| 17: | 9.9 ↑ |
| 18: | 10.1 ↗ |
| 19: | 9.9 ➔ |
| 20: | 10.5x ↙ |
| Serie 96.0 | |
| Total 190.0 | |

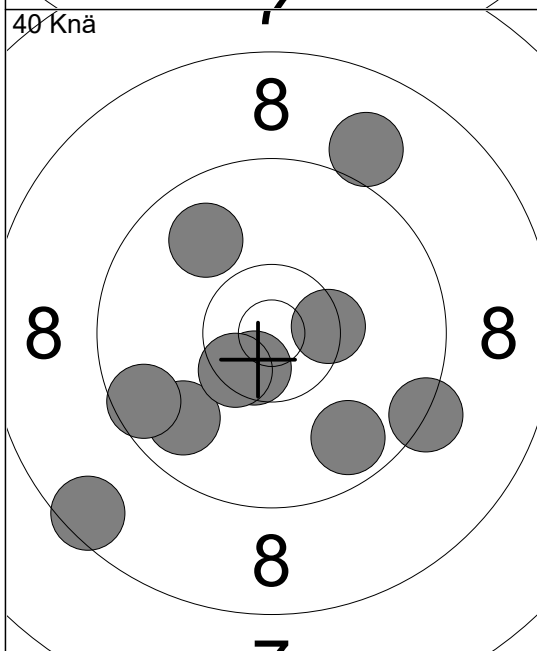

| | |
|-------------|---------|
| 21: | 9.9 ↖ |
| 22: | 9.8 ↘ |
| 23: | 8.5 ↘ |
| 24: | 10.6x ↘ |
| 25: | 9.3 ➔ |
| 26: | 9.0 ↑ |
| 27: | 9.6 ↙ |
| 28: | 10.4x ➔ |
| 29: | 9.7 ↘ |
| 30: | 10.5x ↘ |
| Serie 92.0 | |
| Total 282.0 | |

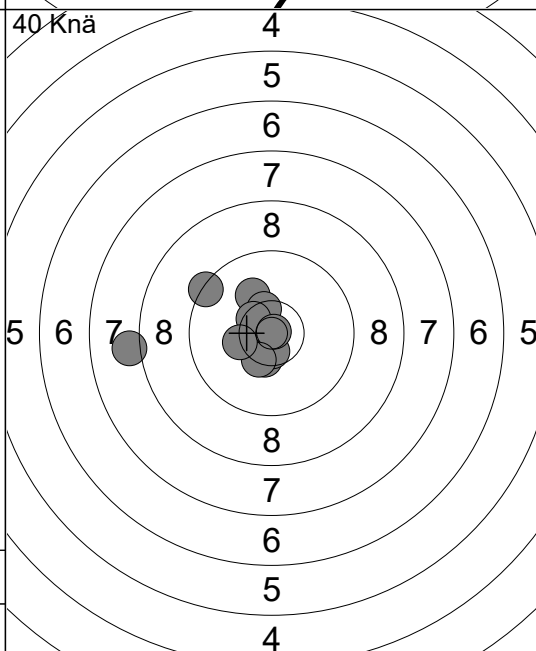

| | |
|-------------|---------|
| 31: | 10.1 ↖ |
| 32: | 10.4x ↘ |
| 33: | 10.4x ↖ |
| 34: | 8.1 ← |
| 35: | 10.5x ↙ |
| 36: | 10.6x ↘ |
| 37: | 10.9x ↗ |
| 38: | 10.4x ↘ |
| 39: | 9.4 ↖ |
| 40: | 10.3x ↙ |
| Serie 97.0 | |
| Total 379.0 | |

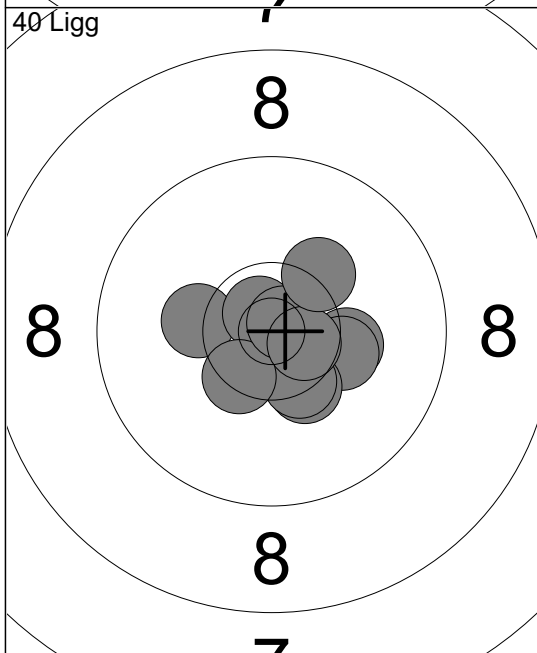

| | |
|-------------|---------|
| 1: | 10.2 ➔ |
| 2: | 10.3 ➔ |
| 3: | 10.3 ↙ |
| 4: | 10.3x ↘ |
| 5: | 10.4x ↘ |
| 6: | 10.7x ↖ |
| 7: | 10.4x ↘ |
| 8: | 10.8x ↗ |
| 9: | 10.6x ➔ |
| 10: | 10.3 ↗ |
| Serie 100.0 | |
| Total 479.0 | |

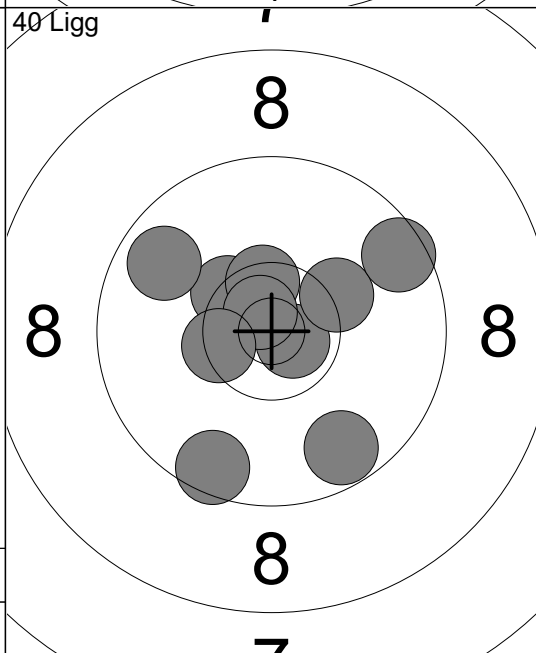

| | |
|-------------|---------|
| 11: | 10.7x ➔ |
| 12: | 9.6 ↘ |
| 13: | 10.2 ↗ |
| 14: | 9.6 ➔ |
| 15: | 10.4x ↙ |
| 16: | 10.5x ↗ |
| 17: | 10.7x ↖ |
| 18: | 9.8 ↖ |
| 19: | 10.4x ↙ |
| 20: | 9.7 ↘ |
| Serie 96.0 | |
| Total 575.0 | |

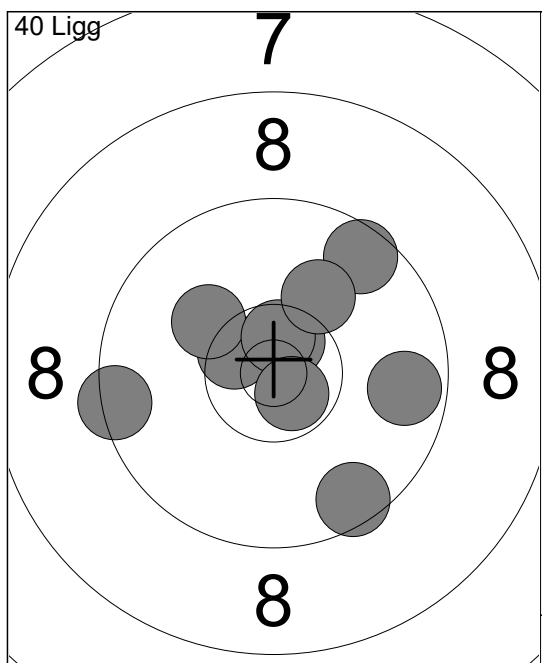

| | |
|-------|---------|
| 21: | 10.6x ↗ |
| 22: | 9.6 ↗ |
| 23: | 10.5x ↘ |
| 24: | 10.2 ↖ |
| 25: | 10.6x ↗ |
| 26: | 10.7x ↘ |
| 27: | 9.4 ← |
| 28: | 10.1 ↗ |
| 29: | 9.7 → |
| 30: | 9.5 ↘ |
| Serie | 96.0 |
| Total | 671.0 |

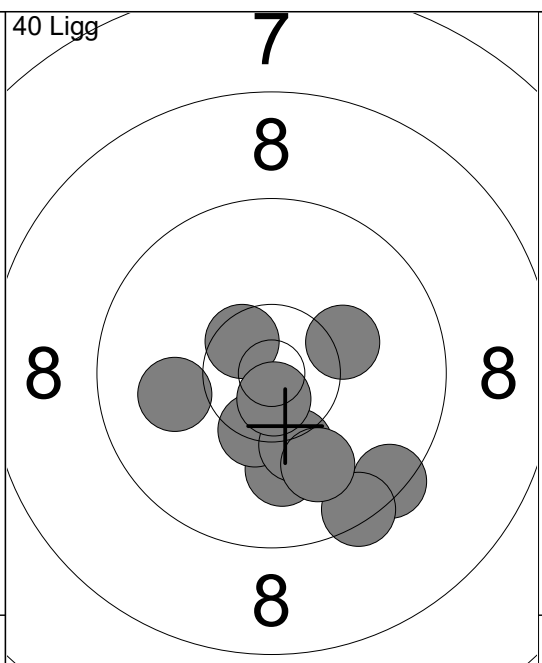

| | |
|-------|---------|
| 31: | 10.2 → |
| 32: | 10.0 ↓ |
| 33: | 10.4x ↘ |
| 34: | 10.2 ↓ |
| 35: | 9.4 ↘ |
| 36: | 10.0 ← |
| 37: | 9.4 ↘ |
| 38: | 10.5x ↘ |
| 39: | 10.0 ↓ |
| 40: | 10.7x ↘ |
| Serie | 98.0 |
| Total | 769.0 |

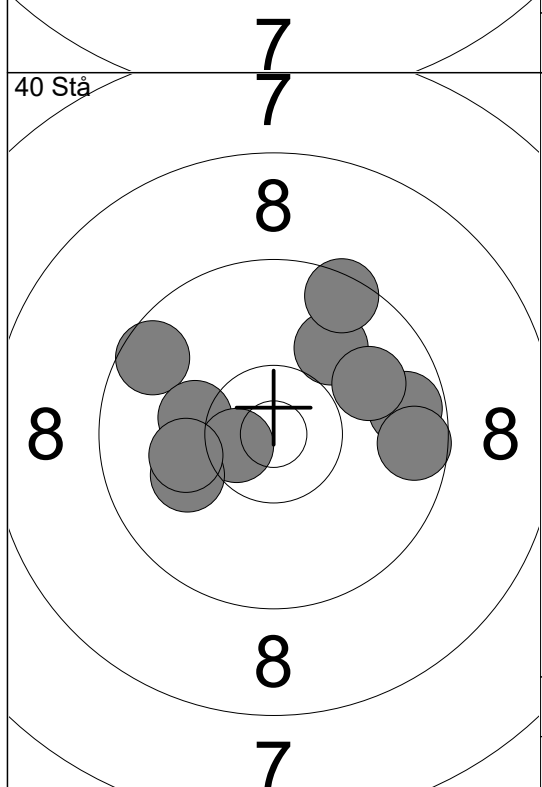

| | |
|-------|---------|
| 1: | 9.6 ← |
| 2: | 10.2 ← |
| 3: | 10.0 ↗ |
| 4: | 9.7 → |
| 5: | 10.6x ↘ |
| 6: | 10.0 ← |
| 7: | 10.1 ← |
| 8: | 9.5 ↗ |
| 9: | 9.6 → |
| 10: | 9.9 ↗ |
| Serie | 95.0 |
| Total | 864.0 |

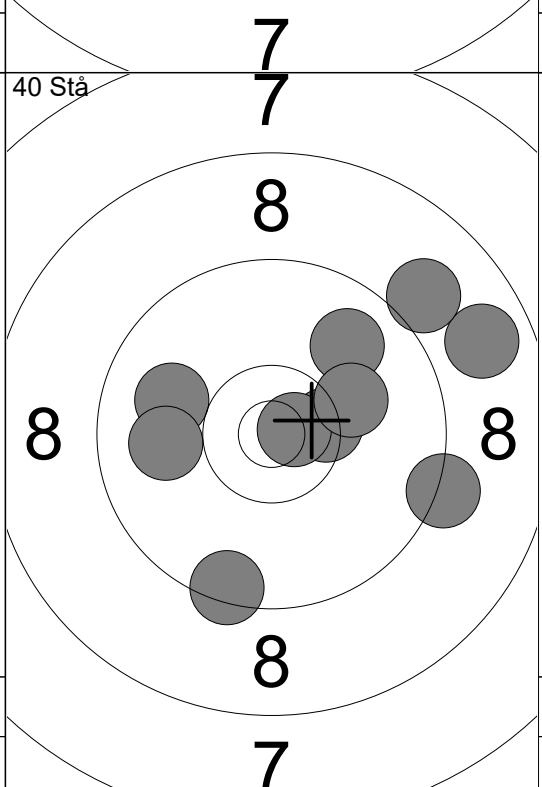

| | |
|-------|---------|
| 11: | 10.0 ← |
| 12: | 8.8 → |
| 13: | 9.9 ← |
| 14: | 9.4 ↓ |
| 15: | 10.4x → |
| 16: | 9.9 ↗ |
| 17: | 10.7x → |
| 18: | 10.1 → |
| 19: | 9.0 ↗ |
| 20: | 9.2 → |
| Serie | 93.0 |
| Total | 957.0 |

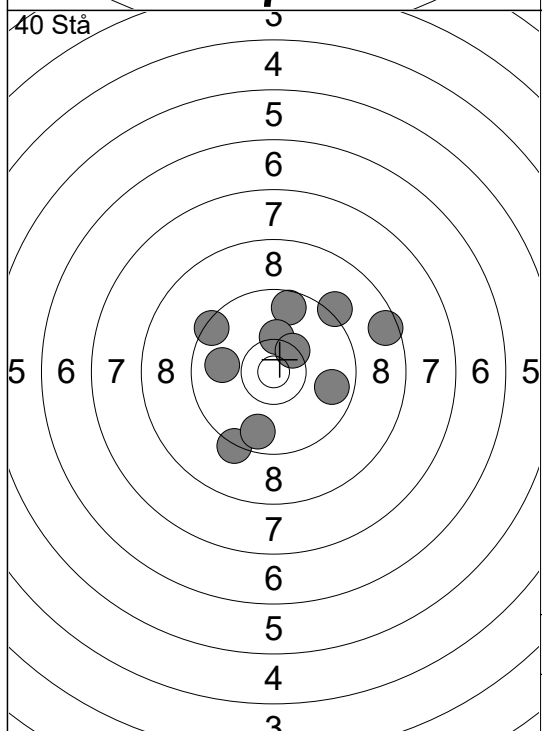

| | |
|-------|---------|
| 21: | 9.3 ↓ |
| 22: | 9.6 ↗ |
| 23: | 9.9 ← |
| 24: | 10.3 ↗ |
| 25: | 8.5 → |
| 26: | 9.7 ↓ |
| 27: | 9.2 ↗ |
| 28: | 9.7 → |
| 29: | 9.4 ↖ |
| 30: | 10.4x ↗ |
| Serie | 91.0 |
| Total | 1048.0 |

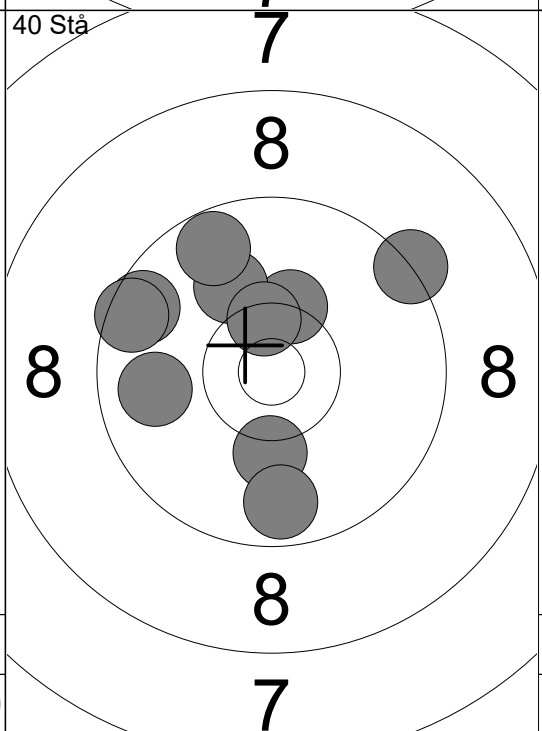

| | |
|-------|---------|
| 31: | 10.3x ↗ |
| 32: | 10.2 ↓ |
| 33: | 9.7 ↓ |
| 34: | 9.8 ← |
| 35: | 9.6 ← |
| 36: | 9.5 ← |
| 37: | 10.1 ↗ |
| 38: | 9.7 ↗ |
| 39: | 9.3 ↗ |
| 40: | 10.4x ↗ |
| Serie | 94.0 |
| Total | 1142.0 |

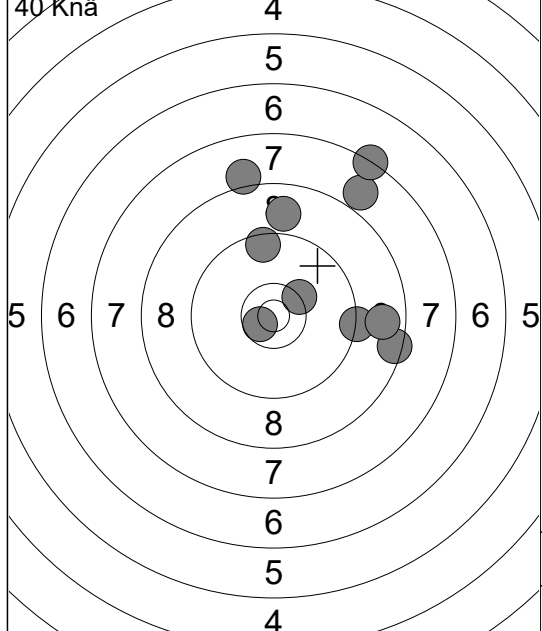

| |
|------------|
| 1: 8.5 → |
| 2: 7.9 ↗ |
| 3: 9.5 ↑ |
| 4: 8.1 ↑ |
| 5: 10.6 ✘ |
| 6: 8.9 ↑ |
| 7: 10.3 ✘ |
| 8: 9.3 → |
| 9: 8.8 → |
| 10: 7.3 ↗ |
| Serie 84.0 |
| Total 84.0 |

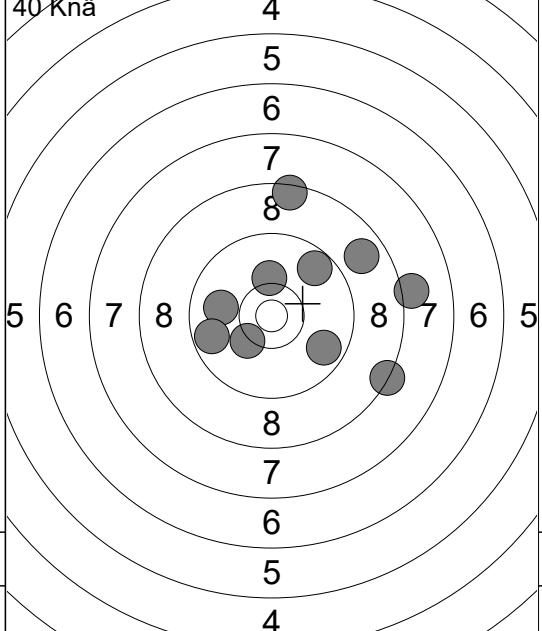

| |
|-------------|
| 11: 9.9 ← |
| 12: 9.7 ← |
| 13: 9.7 ↗ |
| 14: 8.5 ↑ |
| 15: 10.2 ↑ |
| 16: 8.8 ↗ |
| 17: 10.3 ✘ |
| 18: 8.3 → |
| 19: 8.1 → |
| 20: 9.7 → |
| Serie 88.0 |
| Total 172.0 |

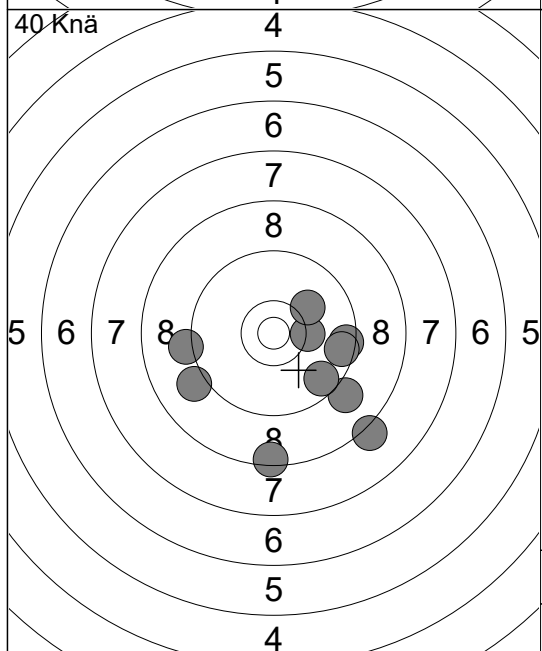

| |
|-------------|
| 21: 8.2 → |
| 22: 9.1 ← |
| 23: 9.5 → |
| 24: 10.3 → |
| 25: 10.1 ↗ |
| 26: 9.1 → |
| 27: 8.4 ↓ |
| 28: 9.6 ↓ |
| 29: 9.2 ← |
| 30: 9.6 → |
| Serie 90.0 |
| Total 262.0 |

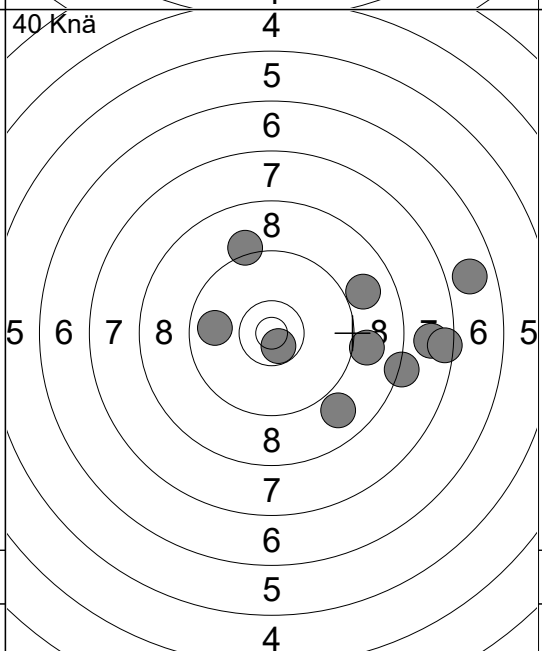

| |
|-------------|
| 31: 7.7 → |
| 32: 8.2 → |
| 33: 9.0 → |
| 34: 10.7 ✘ |
| 35: 8.9 ↓ |
| 36: 6.8 → |
| 37: 7.5 → |
| 38: 9.8 ← |
| 39: 8.9 ↗ |
| 40: 9.2 ↑ |
| Serie 81.0 |
| Total 343.0 |

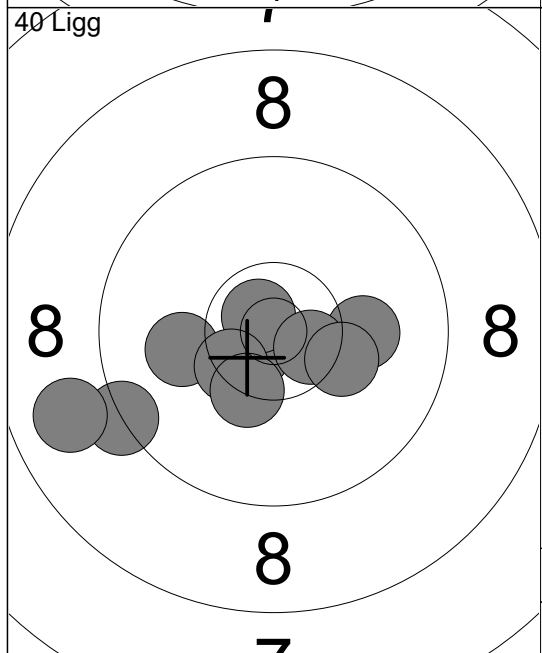

| |
|-------------|
| 1: 10.7 ✘ |
| 2: 9.3 ← |
| 3: 8.9 ← |
| 4: 10.8 ✘ |
| 5: 10.1 ← |
| 6: 10.4 ✘ |
| 7: 10.1 → |
| 8: 10.6 ✘ |
| 9: 10.3 ✘ |
| 10: 10.3 → |
| Serie 97.0 |
| Total 440.0 |

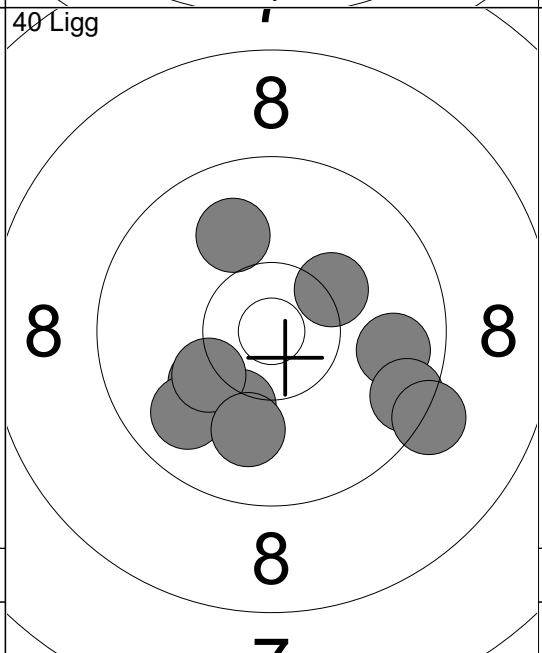

| |
|-------------|
| 11: 10.2 ✘ |
| 12: 10.2 ↓ |
| 13: 9.8 ← |
| 14: 9.8 → |
| 15: 10.0 ↑ |
| 16: 9.5 → |
| 17: 9.3 → |
| 18: 10.2 ✘ |
| 19: 10.0 ↓ |
| 20: 10.3 ↗ |
| Serie 96.0 |
| Total 536.0 |

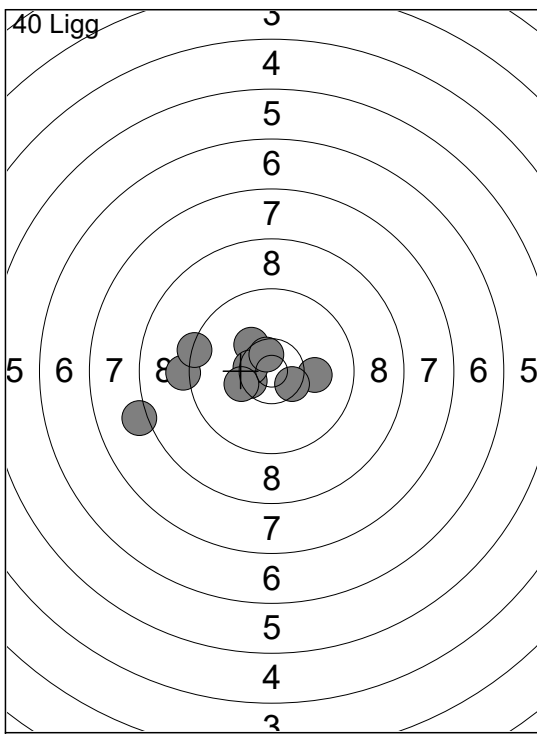

| | | |
|-------|------|-------|
| 21: | 9.2 | ← |
| 22: | 10.3 | ↖ |
| 23: | 10.5 | ✕ |
| 24: | 10.5 | ✕ |
| 25: | 8.1 | ← |
| 26: | 9.3 | ← |
| 27: | 10.6 | ↗ |
| 28: | 10.3 | ✕ |
| 29: | 10.1 | → |
| 30: | 10.5 | ✕ |
| Serie | | 96.0 |
| Total | | 632.0 |

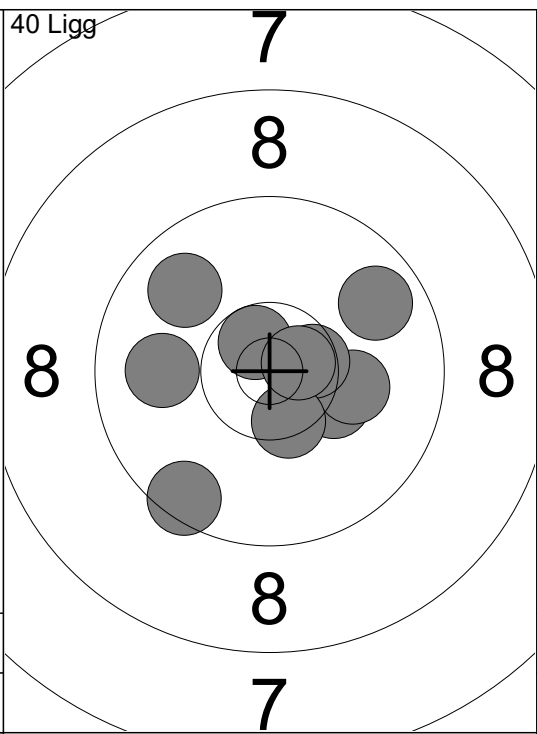

| | | |
|-------|------|-------|
| 31: | 10.3 | ↗ |
| 32: | 10.2 | ↗ |
| 33: | 10.5 | ✕ |
| 34: | 9.8 | ↖ |
| 35: | 10.6 | ↗ |
| 36: | 10.4 | ✕ |
| 37: | 10.7 | ✕ |
| 38: | 9.9 | ← |
| 39: | 9.8 | ↗ |
| 40: | 9.5 | ↙ |
| Serie | | 96.0 |
| Total | | 728.0 |

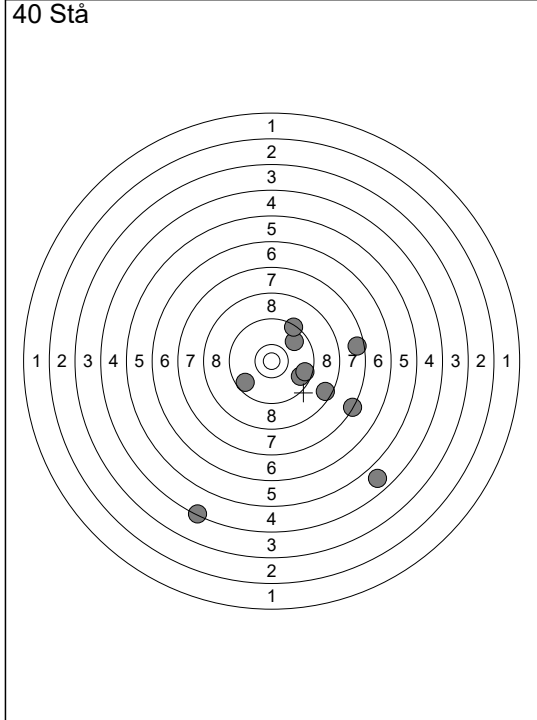

| | | |
|-------|-----|-------|
| 1: | 9.8 | ↗ |
| 2: | 9.7 | → |
| 3: | 9.6 | → |
| 4: | 4.3 | ↙ |
| 5: | 9.6 | ↙ |
| 6: | 7.3 | → |
| 7: | 9.4 | ↗ |
| 8: | 4.8 | ↙ |
| 9: | 8.5 | → |
| 10: | 7.6 | → |
| Serie | | 75.0 |
| Total | | 803.0 |

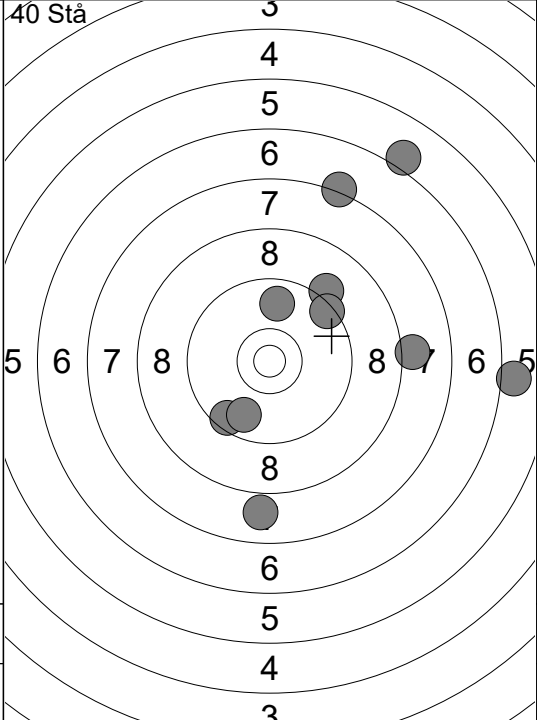

| | | |
|-------|-----|-------|
| 11: | 8.1 | → |
| 12: | 9.8 | ↑ |
| 13: | 9.5 | ↙ |
| 14: | 7.2 | ↗ |
| 15: | 6.1 | ↗ |
| 16: | 9.1 | ↗ |
| 17: | 9.8 | ↙ |
| 18: | 9.4 | ↗ |
| 19: | 7.9 | ↓ |
| 20: | 6.0 | → |
| Serie | | 79.0 |
| Total | | 882.0 |

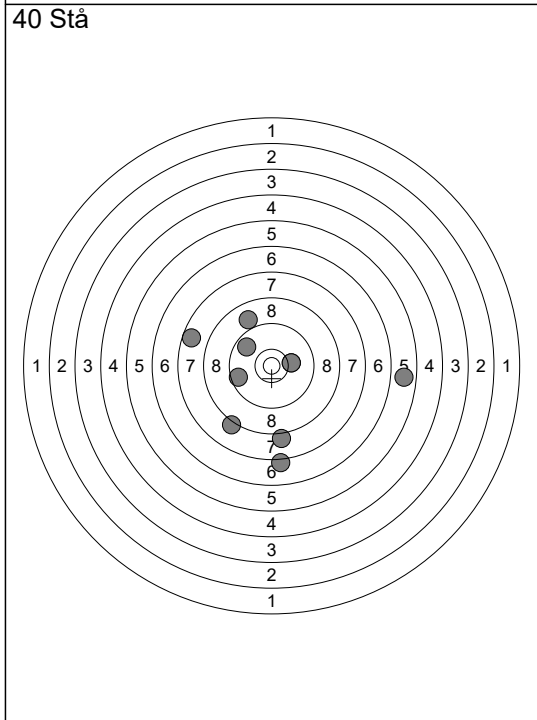

| | | |
|-------|------|-------|
| 21: | 7.6 | ← |
| 22: | 7.2 | ↓ |
| 23: | 9.7 | ↖ |
| 24: | 5.8 | → |
| 25: | 8.9 | ↗ |
| 26: | 10.2 | → |
| 27: | 10.2 | → |
| 28: | 8.1 | ↓ |
| 29: | 8.2 | ↙ |
| 30: | 9.6 | ← |
| Serie | | 81.0 |
| Total | | 963.0 |

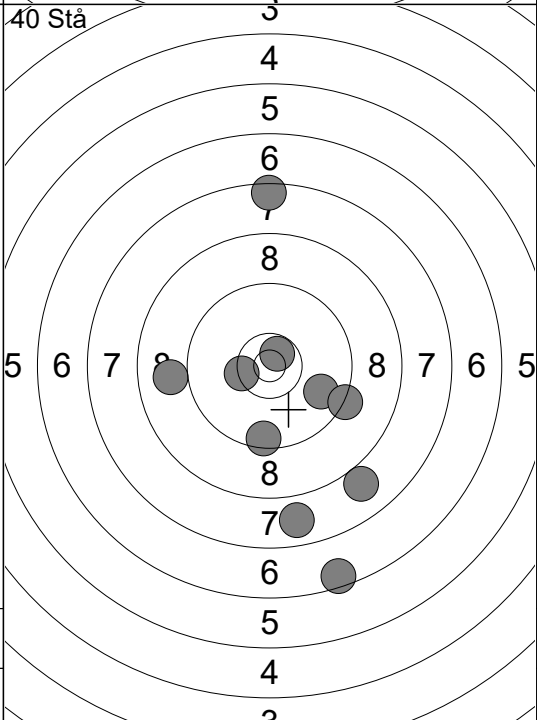

| | | |
|-------|------|--------|
| 31: | 9.5 | ↓ |
| 32: | 7.5 | ↑ |
| 33: | 6.5 | ↙ |
| 34: | 10.7 | ✕ |
| 35: | 7.8 | ↓ |
| 36: | 9.8 | → |
| 37: | 8.9 | ← |
| 38: | 9.3 | → |
| 39: | 10.4 | ✕ |
| 40: | 8.0 | ↙ |
| Serie | | 83.0 |
| Total | | 1046.0 |

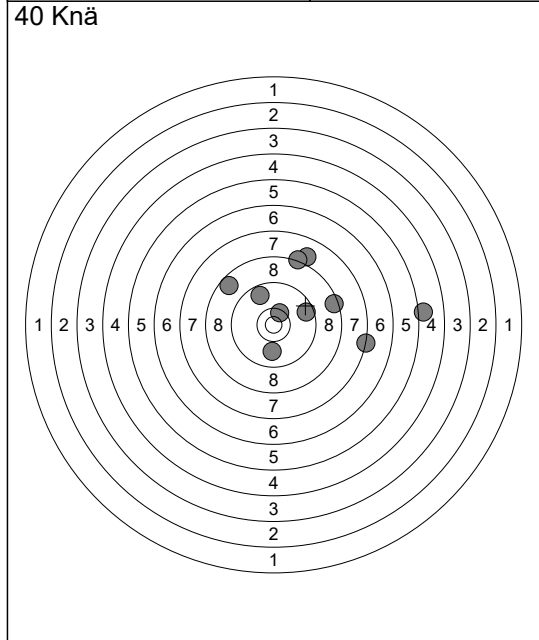

| |
|-------------------|
| 1: 8.5 → |
| 2: 9.6 → |
| 3: 8.6 ↖ |
| 4: 8.0 ↗ |
| 5: 5.1 → |
| 6: 7.3 → |
| 7: 9.7 ↗ |
| 8: 8.3 ↗ |
| 9: 10.4x ↗ |
| 10: 9.9 ↓ |
| Serie 81.0 |
| Total 81.0 |

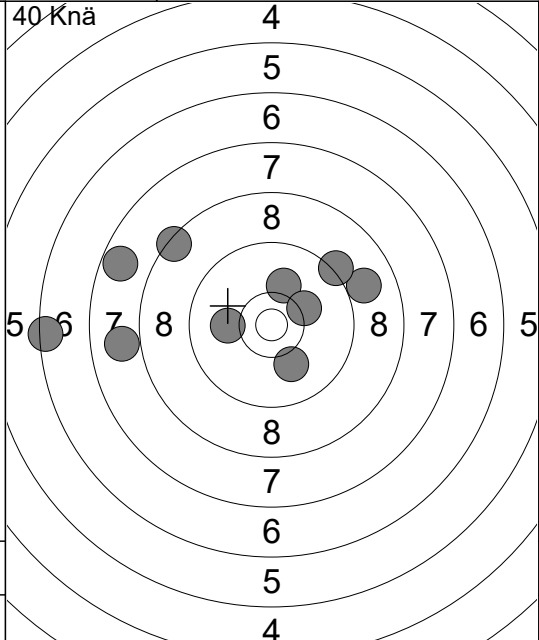

| |
|--------------------|
| 11: 10.1 ↗ |
| 12: 8.9 → |
| 13: 6.4 ← |
| 14: 10.1 ↓ |
| 15: 8.4 ↖ |
| 16: 7.9 ← |
| 17: 9.2 ↗ |
| 18: 10.1 ← |
| 19: 7.7 ↖ |
| 20: 10.2 → |
| Serie 85.0 |
| Total 166.0 |

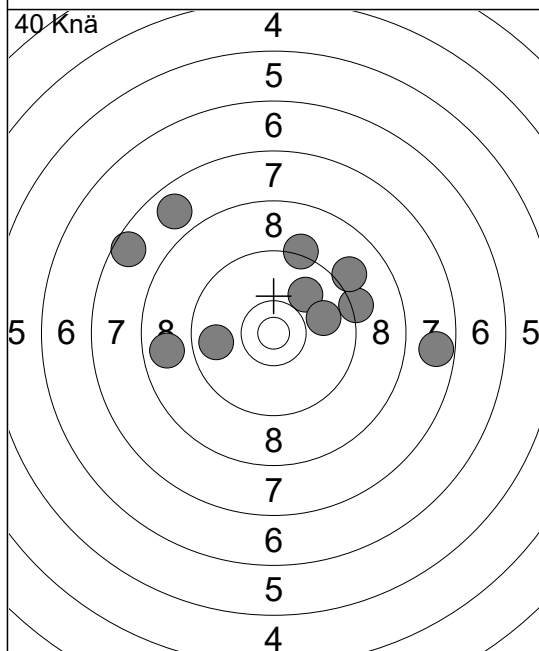

| |
|--------------------|
| 21: 9.9 ↗ |
| 22: 9.2 ↗ |
| 23: 7.8 ↖ |
| 24: 9.8 ← |
| 25: 9.2 → |
| 26: 7.6 ↖ |
| 27: 9.0 ↗ |
| 28: 7.7 → |
| 29: 9.9 → |
| 30: 8.8 ← |
| Serie 83.0 |
| Total 249.0 |

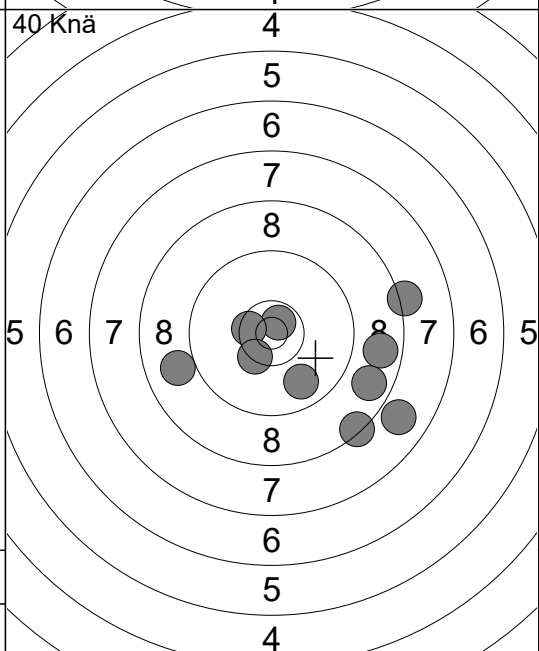

| |
|--------------------|
| 31: 8.7 → |
| 32: 8.9 ← |
| 33: 8.8 → |
| 34: 10.7x ↗ |
| 35: 9.8 ↓ |
| 36: 10.5x ↖ |
| 37: 8.4 ↓ |
| 38: 8.2 → |
| 39: 7.9 ↓ |
| 40: 10.4x ↖ |
| Serie 86.0 |
| Total 335.0 |

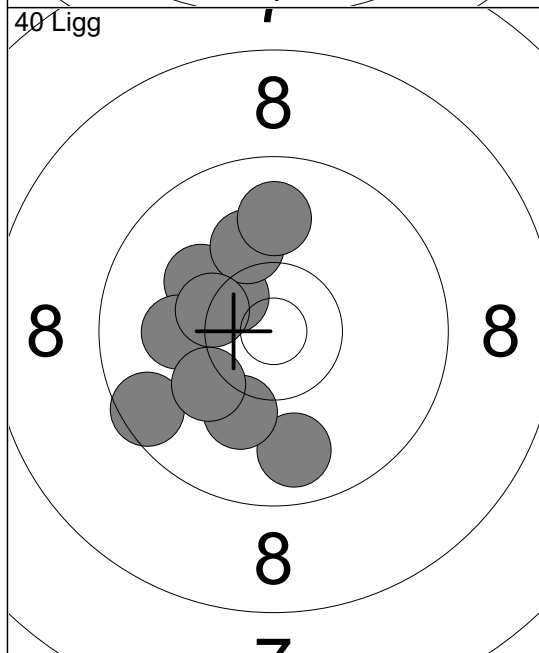

| |
|--------------------|
| 1: 10.4x ↖ |
| 2: 9.8 ↓ |
| 3: 10.1 ↖ |
| 4: 10.1 ↓ |
| 5: 10.1 ↗ |
| 6: 9.5 ↖ |
| 7: 9.9 ↗ |
| 8: 10.1 ← |
| 9: 10.3x ↖ |
| 10: 10.2 ↖ |
| Serie 97.0 |
| Total 432.0 |

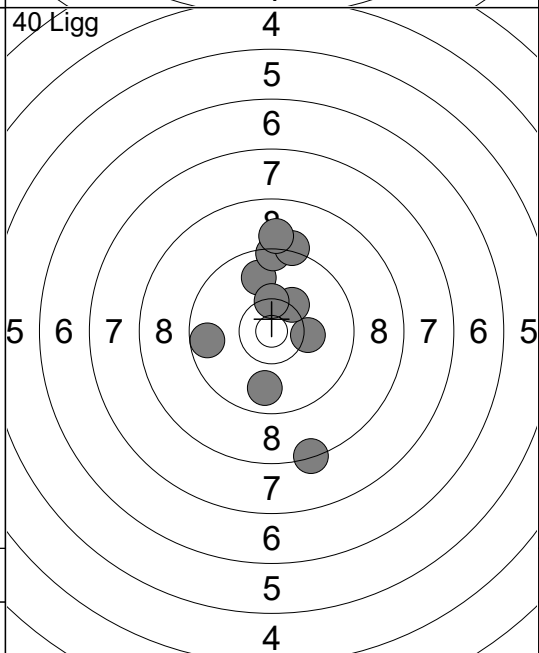

| |
|--------------------|
| 11: 10.2 → |
| 12: 10.3 ↗ |
| 13: 9.8 ↓ |
| 14: 9.8 ↗ |
| 15: 9.4 ↗ |
| 16: 10.3x ↗ |
| 17: 8.3 ↓ |
| 18: 9.2 ↗ |
| 19: 9.7 ← |
| 20: 9.0 ↗ |
| Serie 92.0 |
| Total 524.0 |

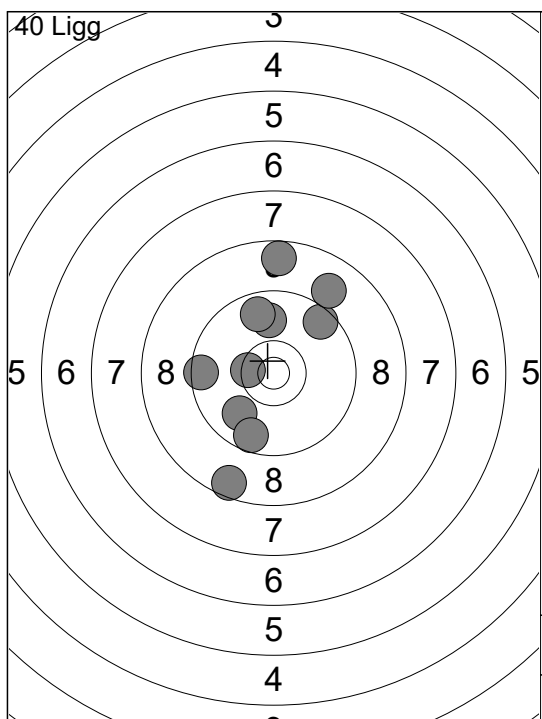

| | | |
|-------|-------|---|
| 21: | 9.9 | ↑ |
| 22: | 9.9 | ↙ |
| 23: | 9.6 | ↗ |
| 24: | 8.6 | ↑ |
| 25: | 9.6 | ↙ |
| 26: | 9.7 | ↑ |
| 27: | 9.0 | ↗ |
| 28: | 10.4 | ↔ |
| 29: | 8.6 | ↙ |
| 30: | 9.5 | ← |
| Serie | 89.0 | |
| Total | 613.0 | |

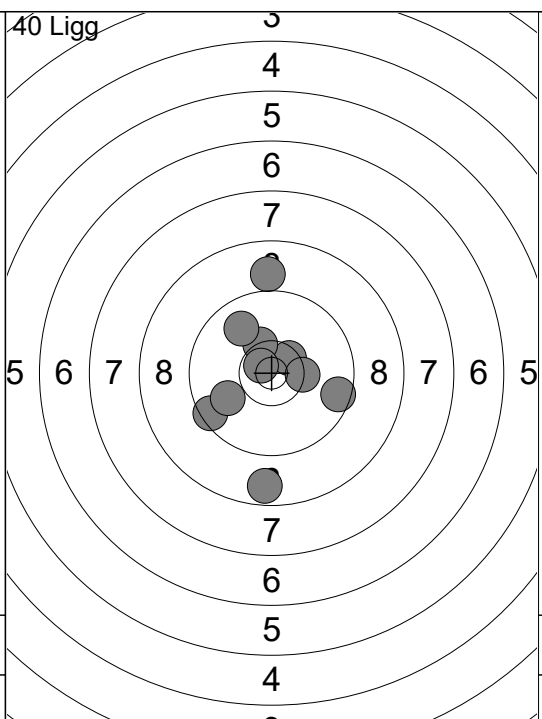

| | | |
|-------|-------|---|
| 31: | 9.6 | → |
| 32: | 9.5 | ↙ |
| 33: | 9.0 | ↑ |
| 34: | 10.5 | ↗ |
| 35: | 10.3 | ↖ |
| 36: | 8.7 | ↓ |
| 37: | 10.3 | → |
| 38: | 10.7 | ↔ |
| 39: | 9.9 | ↙ |
| 40: | 9.9 | ↖ |
| Serie | 93.0 | |
| Total | 706.0 | |

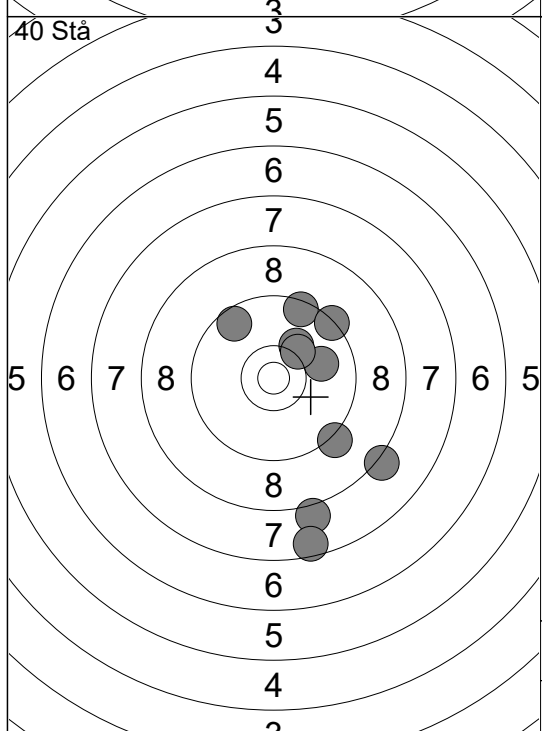

| | | |
|-------|-------|---|
| 1: | 8.1 | ↓ |
| 2: | 10.2 | ↗ |
| 3: | 9.5 | ↑ |
| 4: | 9.6 | ↖ |
| 5: | 8.2 | ↙ |
| 6: | 9.3 | ↗ |
| 7: | 9.9 | → |
| 8: | 10.2 | ↗ |
| 9: | 9.2 | ↙ |
| 10: | 7.6 | ↓ |
| Serie | 88.0 | |
| Total | 794.0 | |

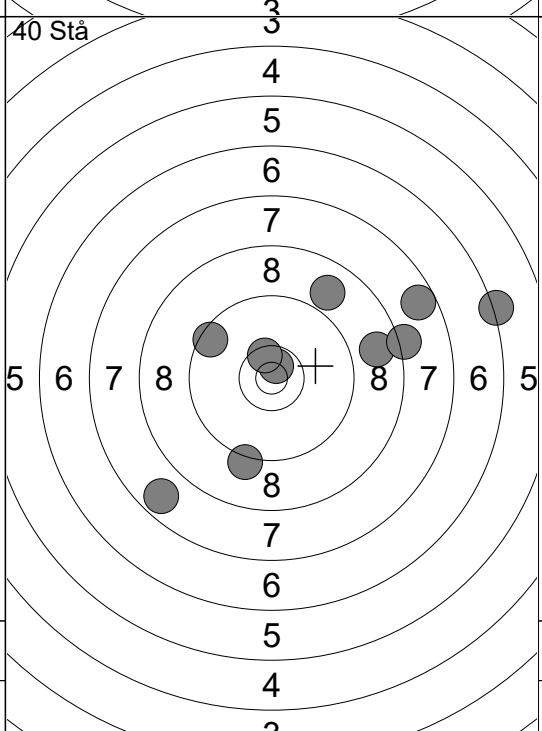

| | | |
|-------|-------|---|
| 11: | 6.2 | → |
| 12: | 8.8 | → |
| 13: | 10.7 | ↖ |
| 14: | 7.7 | ↙ |
| 15: | 10.5 | ↖ |
| 16: | 8.9 | ↗ |
| 17: | 9.5 | ↖ |
| 18: | 8.2 | → |
| 19: | 9.2 | ↓ |
| 20: | 7.6 | ↗ |
| Serie | 82.0 | |
| Total | 876.0 | |

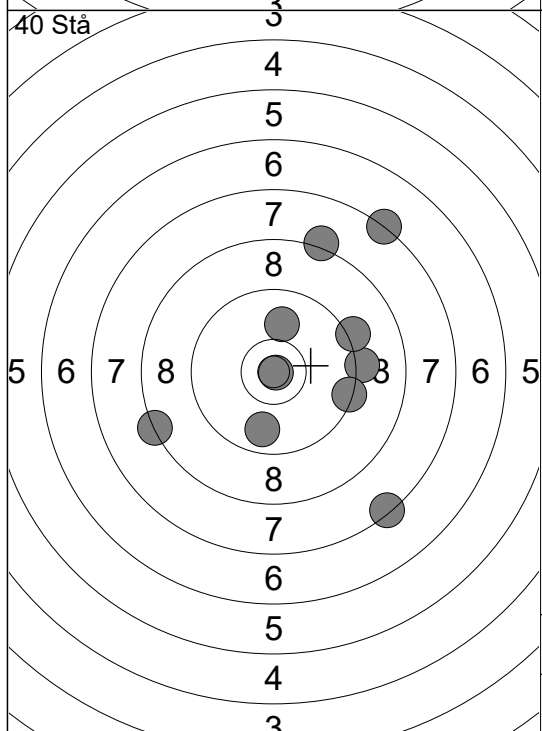

| | | |
|-------|-------|---|
| 21: | 10.9 | → |
| 22: | 7.3 | ↗ |
| 23: | 8.3 | ↙ |
| 24: | 9.8 | ↓ |
| 25: | 10.0 | ↑ |
| 26: | 8.2 | ↗ |
| 27: | 9.2 | → |
| 28: | 9.4 | → |
| 29: | 7.4 | ↙ |
| 30: | 9.2 | ↗ |
| Serie | 86.0 | |
| Total | 962.0 | |

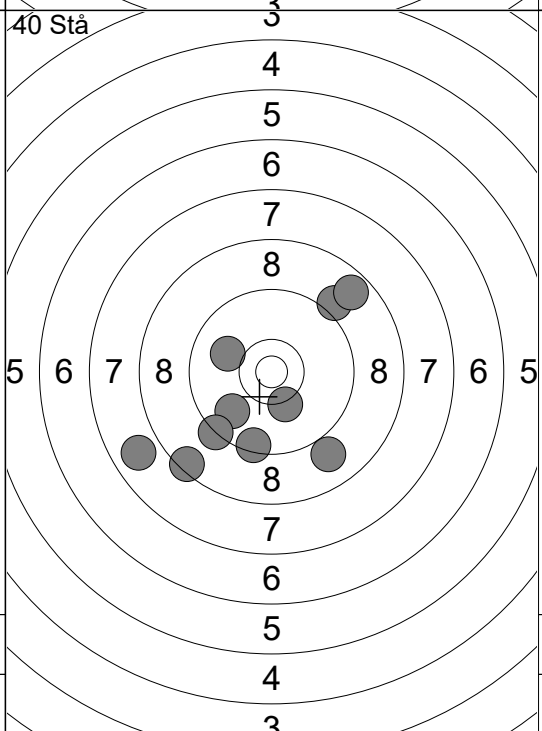

| | | |
|-------|--------|---|
| 31: | 10.2 | ↓ |
| 32: | 8.9 | ↙ |
| 33: | 9.4 | ↓ |
| 34: | 10.0 | ↖ |
| 35: | 9.1 | ↗ |
| 36: | 9.8 | ↙ |
| 37: | 9.3 | ↙ |
| 38: | 8.4 | ↙ |
| 39: | 8.7 | ↗ |
| 40: | 7.8 | ↙ |
| Serie | 87.0 | |
| Total | 1049.0 | |

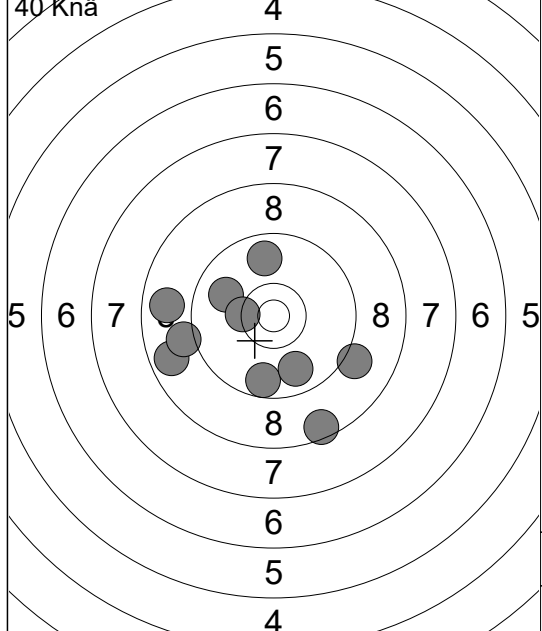

| | | |
|-------|------|------|
| 1: | 9.1 | → |
| 2: | 8.7 | ← |
| 3: | 9.9 | ↖ |
| 4: | 8.8 | ← |
| 5: | 9.6 | ↓ |
| 6: | 10.3 | ↖ |
| 7: | 9.8 | ↓ |
| 8: | 8.5 | ↓ |
| 9: | 9.1 | ← |
| 10: | 9.8 | ↑ |
| Serie | | 88.0 |
| Total | | 88.0 |

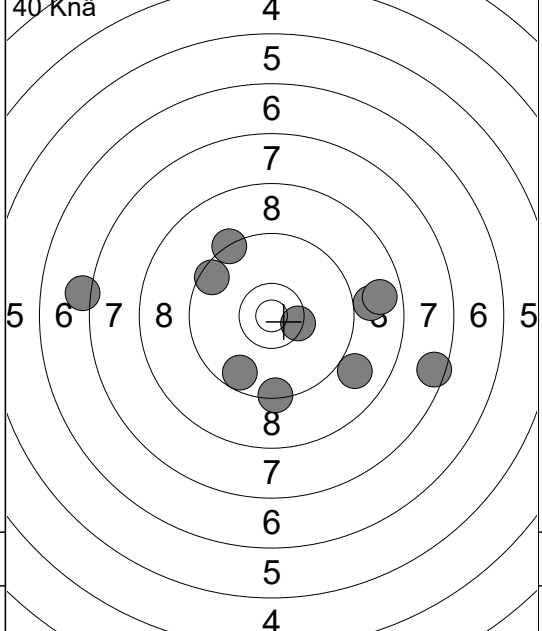

| | | |
|-------|------|-------|
| 11: | 9.0 | ↘ |
| 12: | 10.4 | ↘ |
| 13: | 9.7 | ↘ |
| 14: | 9.4 | ↓ |
| 15: | 8.9 | → |
| 16: | 9.5 | ↖ |
| 17: | 9.3 | ↗ |
| 18: | 7.5 | → |
| 19: | 8.7 | → |
| 20: | 7.1 | ← |
| Serie | | 85.0 |
| Total | | 173.0 |

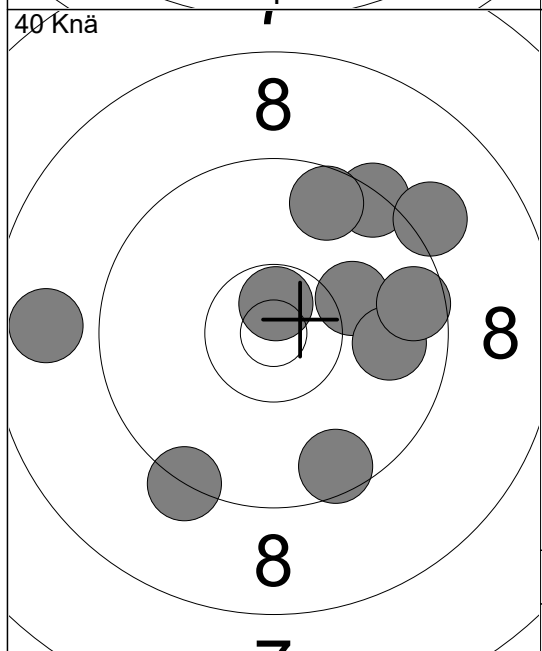

| | | |
|-------|------|-------|
| 21: | 10.1 | → |
| 22: | 10.7 | ↗ |
| 23: | 9.9 | → |
| 24: | 9.4 | ↗ |
| 25: | 9.6 | ↓ |
| 26: | 9.3 | ↘ |
| 27: | 9.6 | → |
| 28: | 8.8 | ← |
| 29: | 9.6 | ↑ |
| 30: | 9.1 | ↗ |
| Serie | | 91.0 |
| Total | | 264.0 |

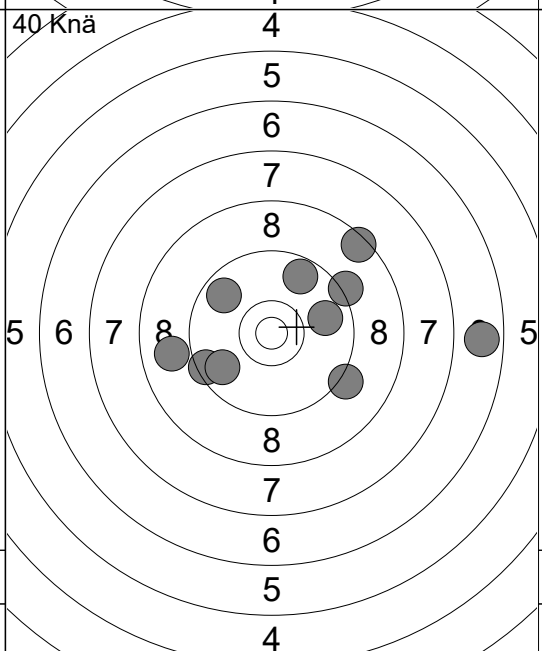

| | | |
|-------|-----|-------|
| 31: | 9.5 | ← |
| 32: | 8.5 | ↗ |
| 33: | 6.7 | → |
| 34: | 9.8 | → |
| 35: | 9.7 | ↖ |
| 36: | 9.2 | ↘ |
| 37: | 9.2 | ↗ |
| 38: | 9.7 | ↗ |
| 39: | 8.9 | ← |
| 40: | 9.8 | ↘ |
| Serie | | 85.0 |
| Total | | 349.0 |

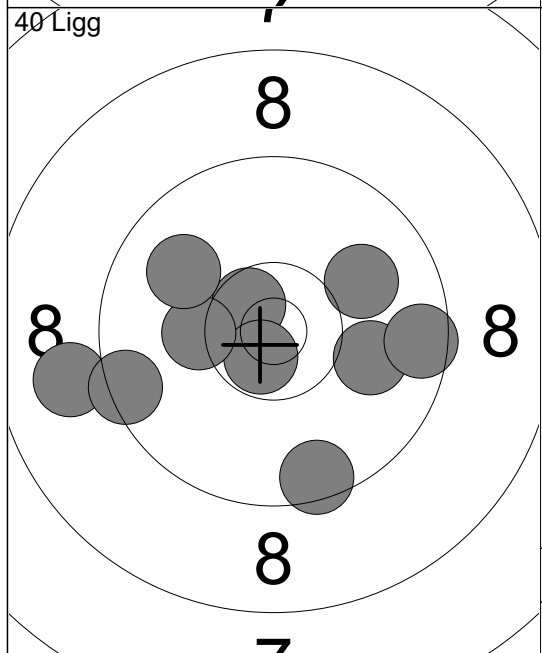

| | | |
|-------|------|-------|
| 1: | 9.5 | ↓ |
| 2: | 10.0 | → |
| 3: | 10.6 | ↖ |
| 4: | 10.0 | ↗ |
| 5: | 9.6 | → |
| 6: | 10.7 | ↘ |
| 7: | 10.2 | ← |
| 8: | 9.9 | ↖ |
| 9: | 9.0 | ← |
| 10: | 9.5 | ← |
| Serie | | 95.0 |
| Total | | 444.0 |

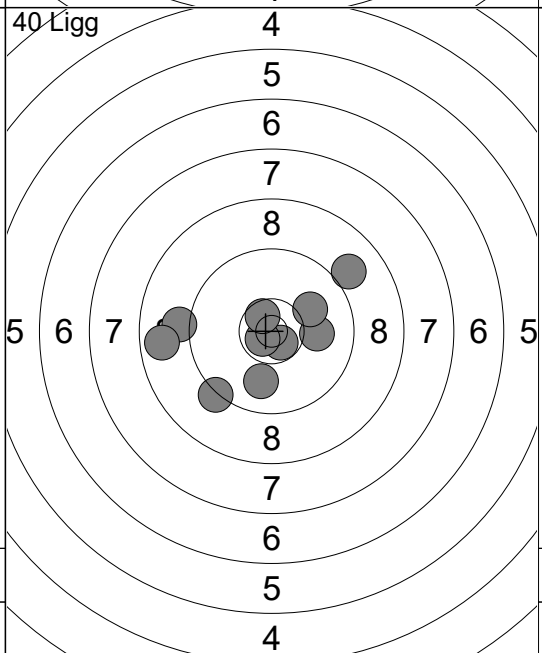

| | | |
|-------|------|-------|
| 11: | 9.1 | ← |
| 12: | 10.6 | ↘ |
| 13: | 9.0 | ↗ |
| 14: | 10.7 | ↖ |
| 15: | 9.3 | ↘ |
| 16: | 10.0 | → |
| 17: | 10.6 | ↖ |
| 18: | 9.9 | ↓ |
| 19: | 8.7 | ← |
| 20: | 10.1 | ↗ |
| Serie | | 94.0 |
| Total | | 538.0 |

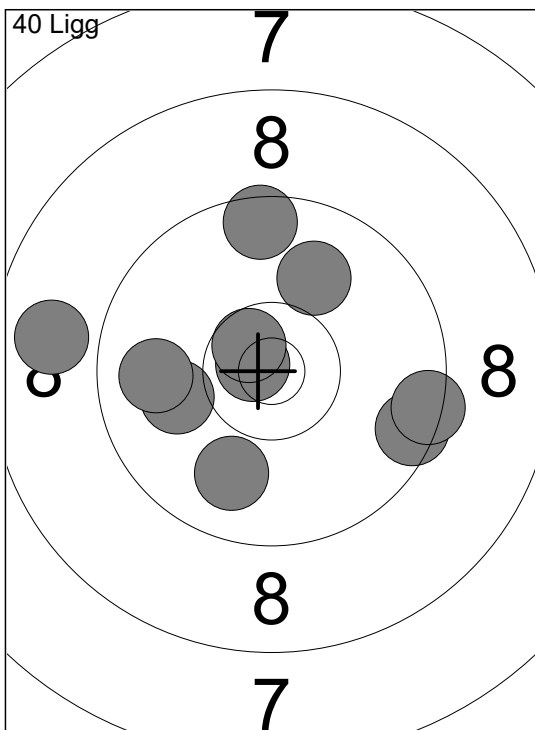

| | |
|-------|-------------------|
| 21: | 10.8 x |
| 22: | 10.6 x |
| 23: | 10.0 ← |
| 24: | 10.0 ↑ |
| 25: | 9.9 ↓ |
| 26: | 8.8 ← |
| 27: | 9.5 → |
| 28: | 9.5 ↑ |
| 29: | 9.4 → |
| 30: | 9.9 ← |
| Serie | 93.0 |
| Total | 631.0 |

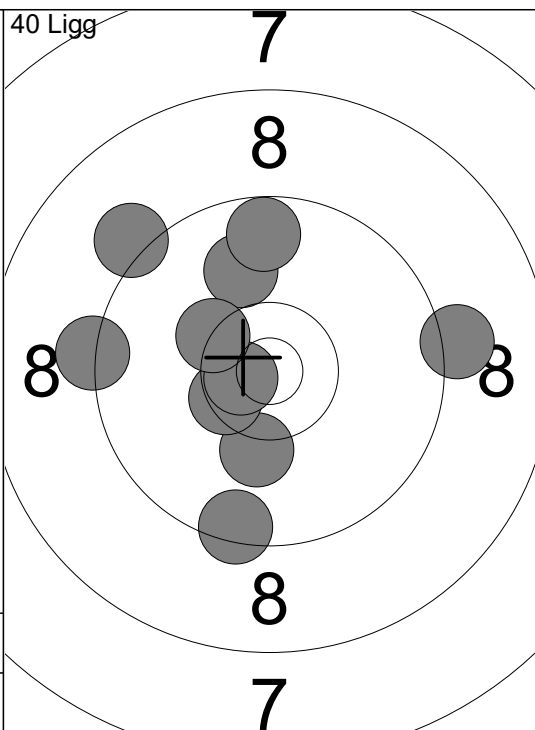

| | |
|-------|-------------------|
| 31: | 10.2 ↓ |
| 32: | 9.2 → |
| 33: | 10.5 x |
| 34: | 10.7 x |
| 35: | 10.0 ↑ |
| 36: | 9.7 ↑ |
| 37: | 9.3 ← |
| 38: | 9.4 ↓ |
| 39: | 10.3 x |
| 40: | 9.2 ↖ |
| Serie | 95.0 |
| Total | 726.0 |

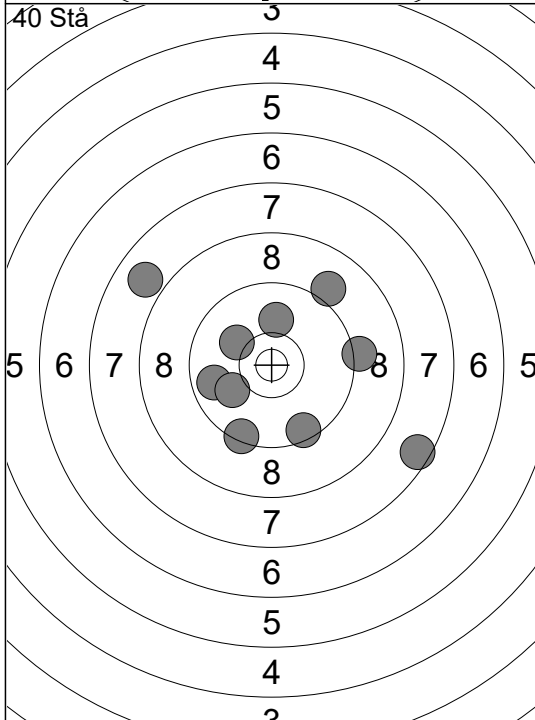

| | |
|-------|-------------------|
| 1: | 9.7 ← |
| 2: | 10.0 ↑ |
| 3: | 10.1 ↖ |
| 4: | 7.9 ↖ |
| 5: | 9.2 → |
| 6: | 10.0 ↖ |
| 7: | 9.4 ↓ |
| 8: | 9.0 ↑ |
| 9: | 9.5 ↓ |
| 10: | 7.5 → |
| Serie | 89.0 |
| Total | 815.0 |

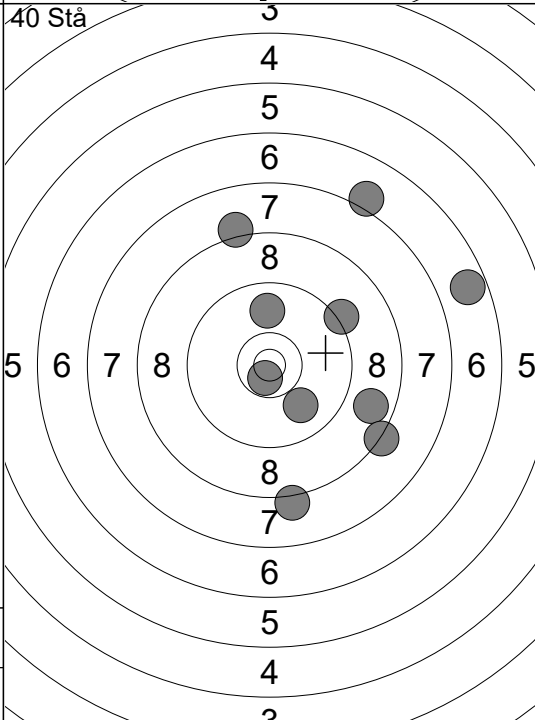

| | |
|-------|-------------------|
| 11: | 9.9 ↑ |
| 12: | 8.8 → |
| 13: | 9.2 ↗ |
| 14: | 10.7 x |
| 15: | 8.2 ↑ |
| 16: | 8.2 ↓ |
| 17: | 8.3 ↘ |
| 18: | 9.9 ↓ |
| 19: | 6.7 → |
| 20: | 7.1 ↑ |
| Serie | 82.0 |
| Total | 897.0 |

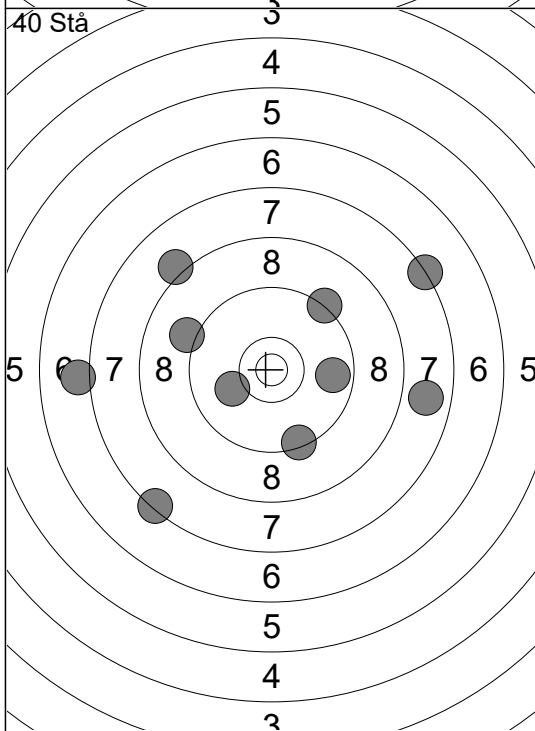

| | |
|-------|-------------------|
| 21: | 7.4 ↖ |
| 22: | 7.8 → |
| 23: | 7.3 ↗ |
| 24: | 10.1 ↖ |
| 25: | 9.1 ← |
| 26: | 9.4 ↓ |
| 27: | 8.1 ↖ |
| 28: | 9.7 → |
| 29: | 9.3 ↗ |
| 30: | 7.1 ← |
| Serie | 82.0 |
| Total | 979.0 |

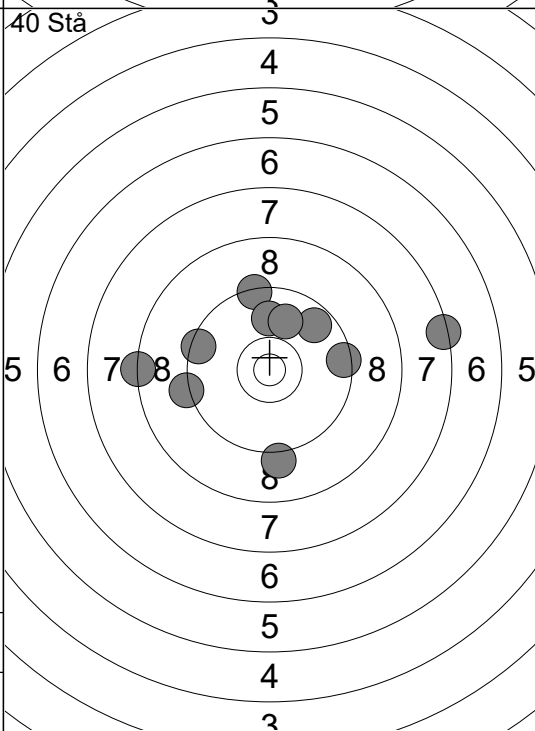

| | |
|-------|------------------|
| 31: | 9.7 ↗ |
| 32: | 9.5 ← |
| 33: | 9.5 → |
| 34: | 9.4 ↑ |
| 35: | 9.9 ↑ |
| 36: | 9.1 ↓ |
| 37: | 8.3 ← |
| 38: | 9.9 ↑ |
| 39: | 9.2 ← |
| 40: | 7.4 → |
| Serie | 87.0 |
| Total | 1066.0 |

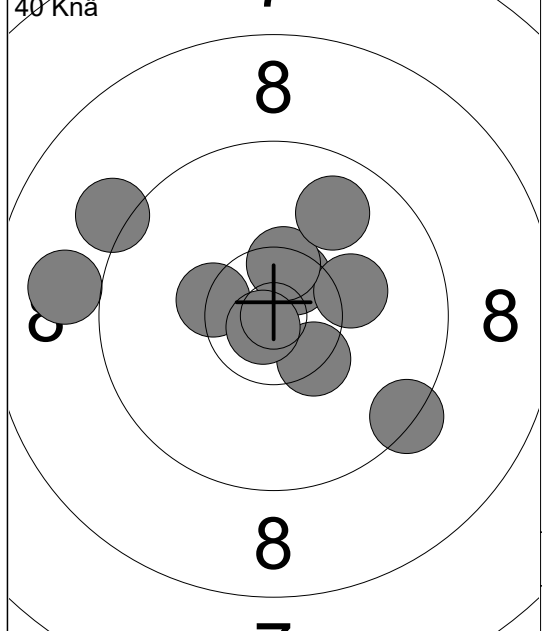

| | |
|------------|---------|
| 1: | 10.5x ↗ |
| 2: | 10.4x ↘ |
| 3: | 10.2 → |
| 4: | 9.2 ↖ |
| 5: | 10.4x ↗ |
| 6: | 9.8 ↗ |
| 7: | 10.4x ↘ |
| 8: | 10.8x ↘ |
| 9: | 9.4 ↘ |
| 10: | 9.0 ← |
| Serie 96.0 | |
| Total 96.0 | |

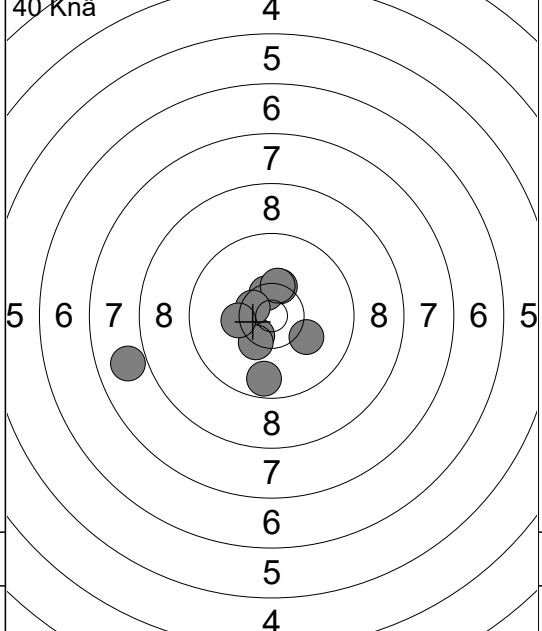

| | |
|-------------|---------|
| 11: | 10.3x ↗ |
| 12: | 10.5x ↘ |
| 13: | 9.7 ↓ |
| 14: | 10.5x ↗ |
| 15: | 10.3x ↗ |
| 16: | 10.1 → |
| 17: | 10.5x ↘ |
| 18: | 10.3x ↘ |
| 19: | 10.3 ← |
| 20: | 7.9 ← |
| Serie 96.0 | |
| Total 192.0 | |

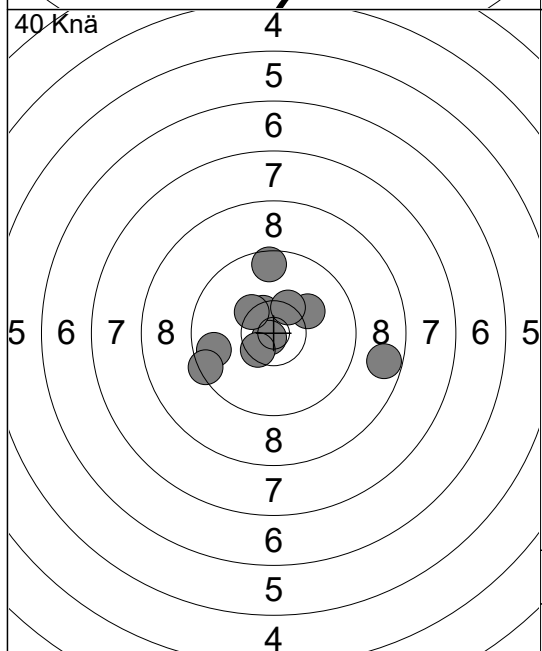

| | |
|-------------|---------|
| 21: | 9.6 ↑ |
| 22: | 10.5x ↘ |
| 23: | 9.7 ← |
| 24: | 9.4 ← |
| 25: | 10.1 ↗ |
| 26: | 8.7 → |
| 27: | 10.8x ↘ |
| 28: | 10.4x ↗ |
| 29: | 10.3x ↘ |
| 30: | 10.5x ↘ |
| Serie 95.0 | |
| Total 287.0 | |

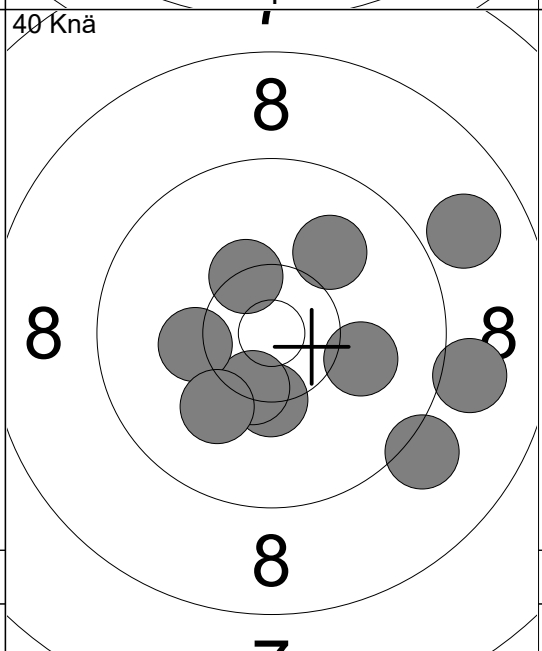

| | |
|-------------|---------|
| 31: | 10.4x ↘ |
| 32: | 10.3x ↘ |
| 33: | 10.0 ↗ |
| 34: | 10.1 → |
| 35: | 9.0 → |
| 36: | 10.4x ↘ |
| 37: | 8.9 ↗ |
| 38: | 10.2 ← |
| 39: | 9.1 ↘ |
| 40: | 10.1 ↘ |
| Serie 96.0 | |
| Total 383.0 | |

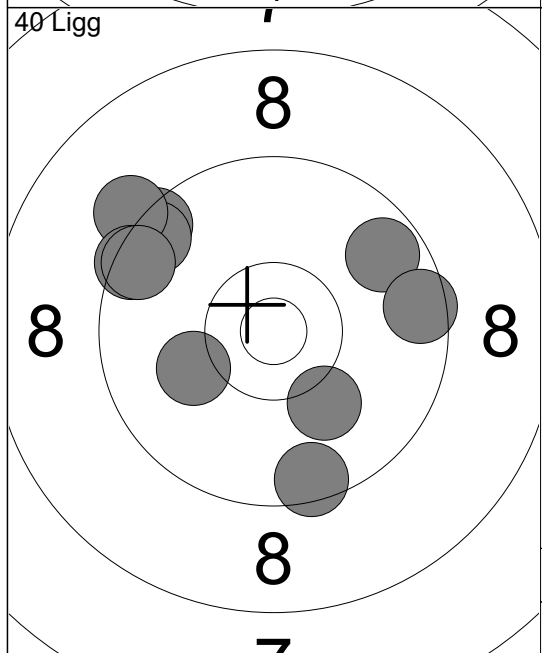

| | |
|-------------|--------|
| 1: | 9.5 ↓ |
| 2: | 10.1 ↘ |
| 3: | 10.1 ← |
| 4: | 9.5 ↗ |
| 5: | 9.5 ↗ |
| 6: | 9.2 ↗ |
| 7: | 9.5 ↖ |
| 8: | 9.5 ↖ |
| 9: | 9.7 ↗ |
| 10: | 9.6 → |
| Serie 92.0 | |
| Total 475.0 | |

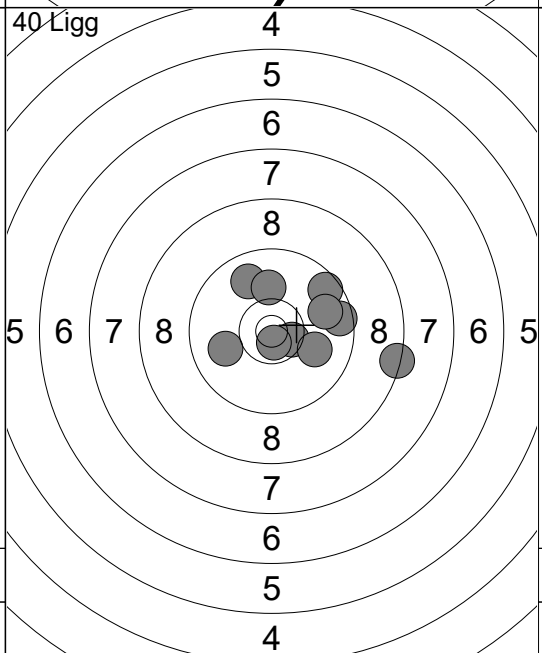

| | |
|-------------|---------|
| 11: | 9.9 ↖ |
| 12: | 10.1 ↑ |
| 13: | 10.5x → |
| 14: | 9.6 → |
| 15: | 8.4 → |
| 16: | 9.6 ↗ |
| 17: | 9.8 → |
| 18: | 10.7x ↘ |
| 19: | 10.0 → |
| 20: | 10.0 ← |
| Serie 94.0 | |
| Total 569.0 | |

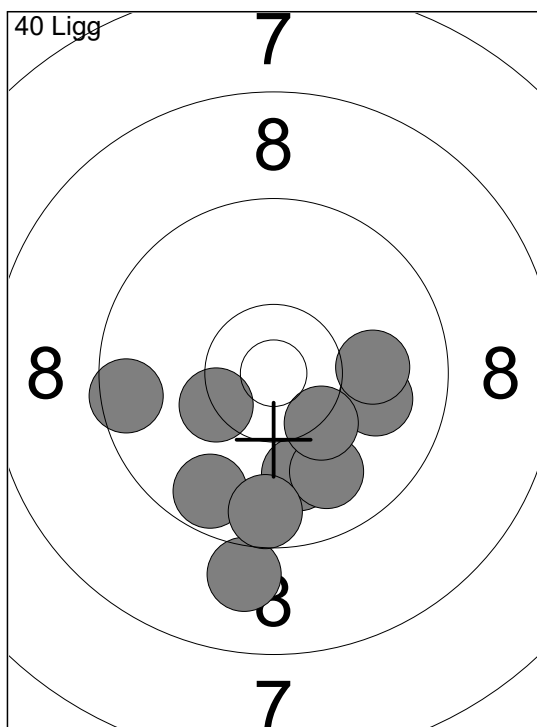

| | | |
|-------|------|-------|
| 21: | 9.7 | ↙ |
| 22: | 10.0 | ↓ |
| 23: | 9.0 | ↓ |
| 24: | 9.9 | ↓ |
| 25: | 10.0 | → |
| 26: | 9.6 | ↓ |
| 27: | 10.3 | ↘ |
| 28: | 9.5 | ← |
| 29: | 10.3 | ↘ |
| 30: | 10.0 | → |
| Serie | | 95.0 |
| Total | | 664.0 |

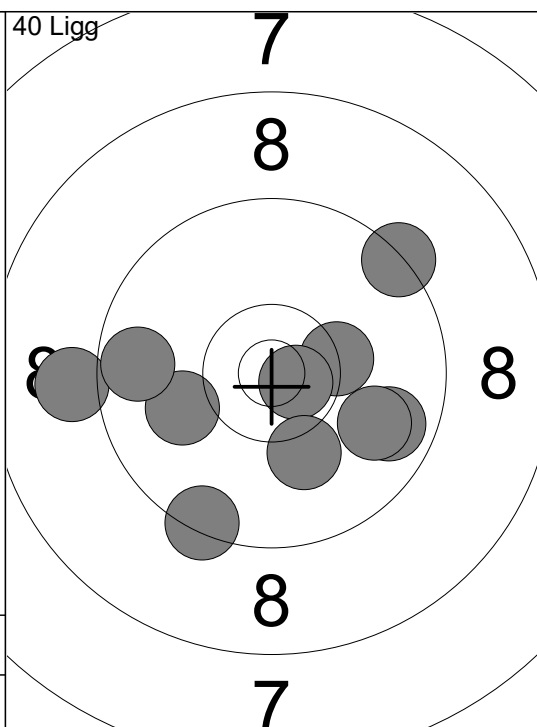

| | | |
|-------|------|-------|
| 31: | 9.4 | ↙ |
| 32: | 10.1 | ← |
| 33: | 9.1 | ← |
| 34: | 9.7 | ← |
| 35: | 10.3 | ↗ |
| 36: | 10.7 | ↗ |
| 37: | 10.1 | ↓ |
| 38: | 9.7 | → |
| 39: | 9.9 | → |
| 40: | 9.3 | ↗ |
| Serie | | 94.0 |
| Total | | 758.0 |

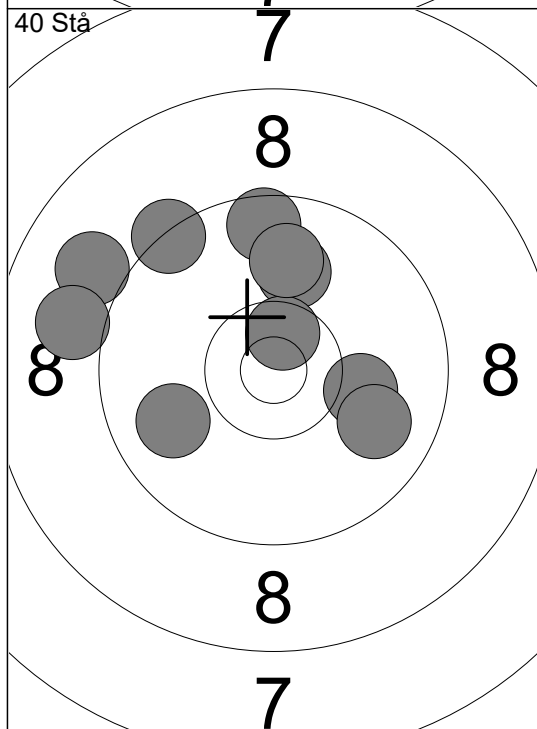

| | | |
|-------|------|-------|
| 1: | 9.3 | ↖ |
| 2: | 10.1 | → |
| 3: | 9.9 | → |
| 4: | 9.0 | ↖ |
| 5: | 9.9 | ↖ |
| 6: | 10.0 | ↑ |
| 7: | 10.6 | ↗ |
| 8: | 9.6 | ↑ |
| 9: | 9.9 | ↑ |
| 10: | 9.0 | ← |
| Serie | | 93.0 |
| Total | | 851.0 |

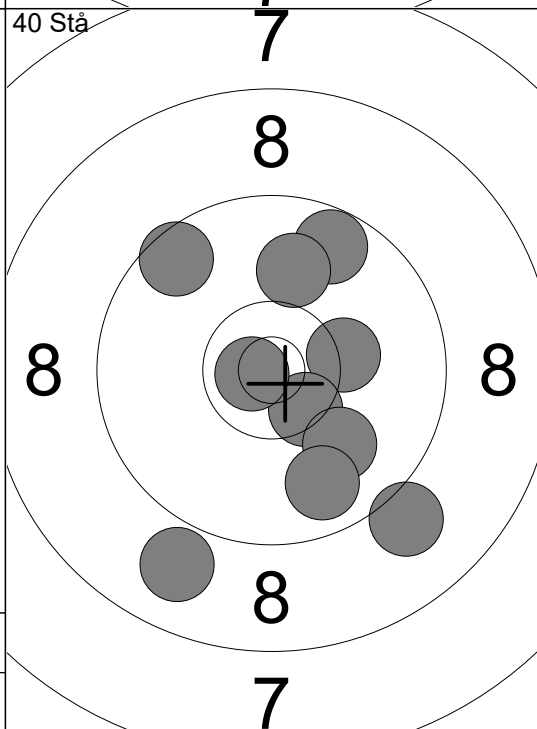

| | | |
|-------|------|-------|
| 11: | 10.3 | → |
| 12: | 9.7 | ↗ |
| 13: | 9.1 | ↓ |
| 14: | 8.9 | ↓ |
| 15: | 10.5 | ↘ |
| 16: | 10.8 | ↘ |
| 17: | 10.0 | ↓ |
| 18: | 9.8 | ↓ |
| 19: | 9.6 | ↖ |
| 20: | 10.0 | ↑ |
| Serie | | 94.0 |
| Total | | 945.0 |

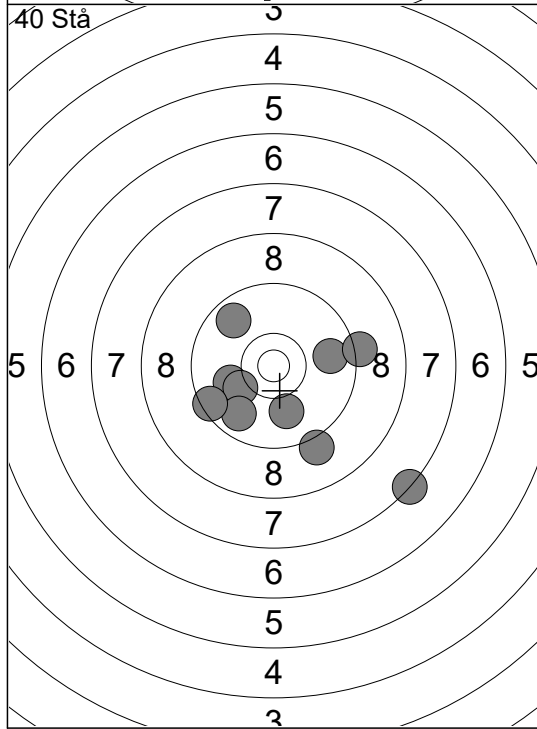

| | | |
|-------|------|--------|
| 21: | 9.8 | → |
| 22: | 10.0 | ↓ |
| 23: | 10.0 | ← |
| 24: | 9.7 | ↖ |
| 25: | 9.2 | → |
| 26: | 10.2 | ↘ |
| 27: | 7.3 | ↘ |
| 28: | 9.8 | ↘ |
| 29: | 9.1 | ↓ |
| 30: | 9.5 | ↖ |
| Serie | | 91.0 |
| Total | | 1036.0 |

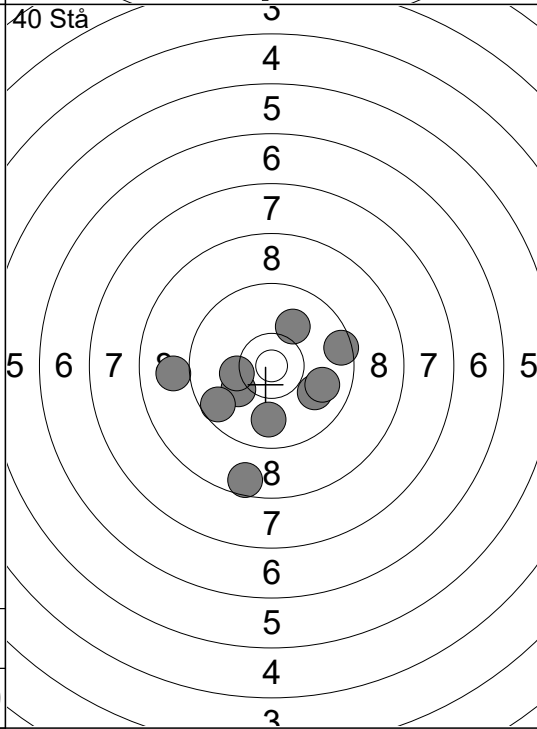

| | | |
|-------|------|--------|
| 31: | 9.9 | → |
| 32: | 8.6 | ↓ |
| 33: | 10.1 | ↗ |
| 34: | 10.1 | ← |
| 35: | 10.2 | ← |
| 36: | 9.5 | → |
| 37: | 9.9 | → |
| 38: | 9.0 | ← |
| 39: | 9.9 | ↓ |
| 40: | 9.6 | ↖ |
| Serie | | 92.0 |
| Total | | 1128.0 |

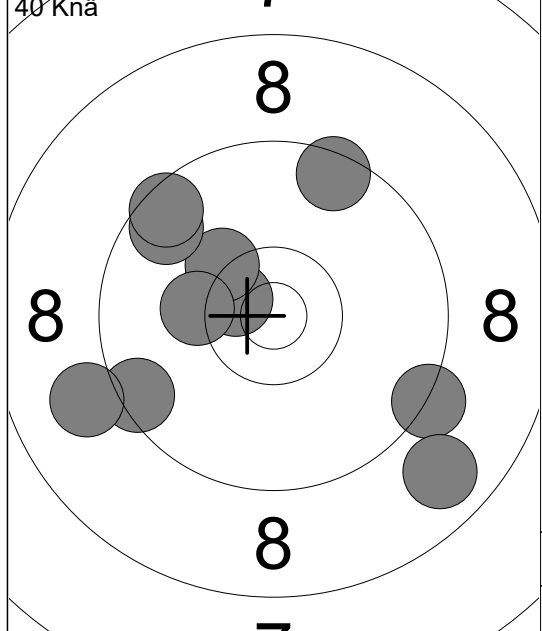

| | |
|------------|---------|
| 1: | 10.6x ↘ |
| 2: | 9.5 ↙ |
| 3: | 10.3 ↗ |
| 4: | 9.6 ↗ |
| 5: | 9.5 ↗ |
| 6: | 9.5 ↗ |
| 7: | 10.2 ↙ |
| 8: | 9.0 ↙ |
| 9: | 9.3 ➔ |
| 10: | 8.8 ↘ |
| Serie 92.0 | |
| Total 92.0 | |

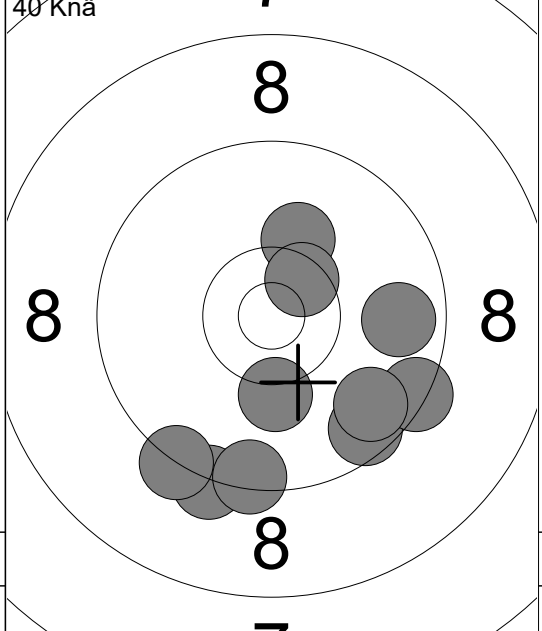

| | |
|-------------|---------|
| 11: | 10.2 ↓ |
| 12: | 9.8 ➔ |
| 13: | 9.3 ↓ |
| 14: | 10.2 ↗ |
| 15: | 9.3 ↓ |
| 16: | 9.4 ↓ |
| 17: | 9.6 ↓ |
| 18: | 9.4 ➔ |
| 19: | 9.7 ↘ |
| 20: | 10.5x ↗ |
| Serie 93.0 | |
| Total 185.0 | |

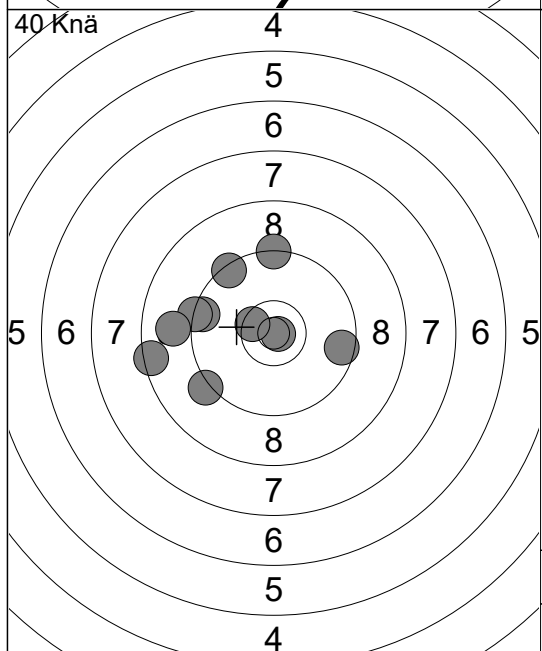

| | |
|-------------|---------|
| 21: | 9.6 ➔ |
| 22: | 10.9x ➔ |
| 23: | 8.4 ↙ |
| 24: | 9.4 ↗ |
| 25: | 9.5 ↙ |
| 26: | 9.3 ↗ |
| 27: | 9.3 ↙ |
| 28: | 10.5x ↘ |
| 29: | 9.2 ↙ |
| 30: | 8.9 ↙ |
| Serie 90.0 | |
| Total 275.0 | |

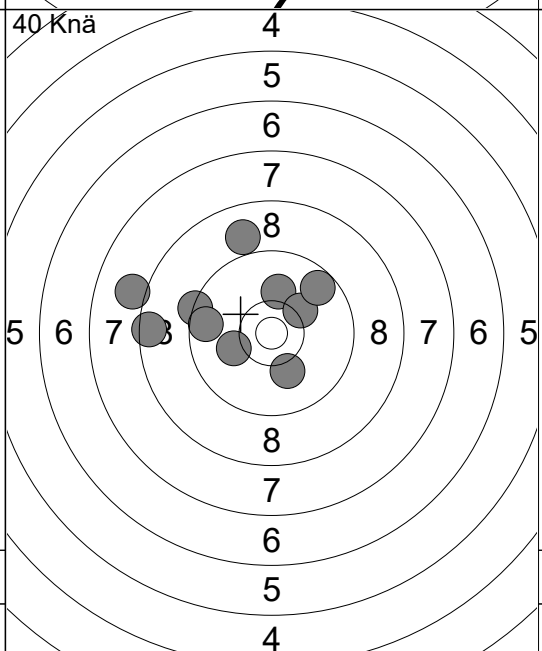

| | |
|-------------|--------|
| 31: | 8.0 ↙ |
| 32: | 10.1 ↗ |
| 33: | 9.3 ↙ |
| 34: | 8.9 ↗ |
| 35: | 10.1 ↙ |
| 36: | 8.5 ↙ |
| 37: | 9.6 ↙ |
| 38: | 10.2 ↗ |
| 39: | 10.1 ↓ |
| 40: | 9.7 ↗ |
| Serie 91.0 | |
| Total 366.0 | |

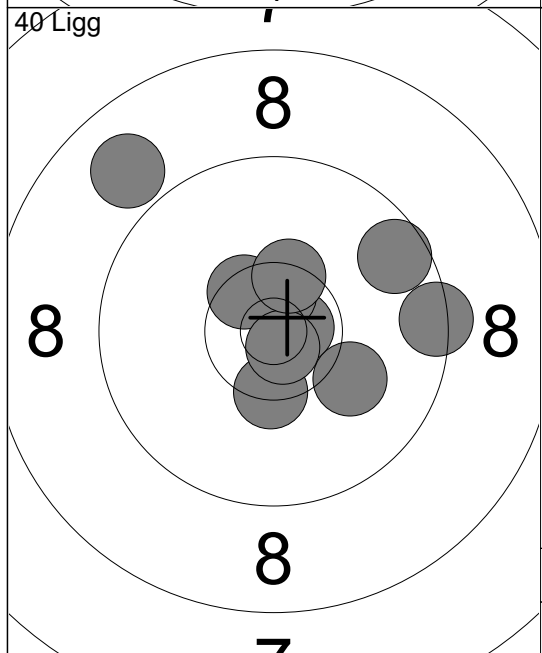

| | |
|-------------|---------|
| 1: | 9.4 ➔ |
| 2: | 9.6 ↗ |
| 3: | 10.7x ➔ |
| 4: | 10.6x ↗ |
| 5: | 10.5x ↘ |
| 6: | 10.4x ↓ |
| 7: | 10.1 ➔ |
| 8: | 8.9 ↗ |
| 9: | 10.8x ↘ |
| 10: | 10.4x ↗ |
| Serie 96.0 | |
| Total 462.0 | |

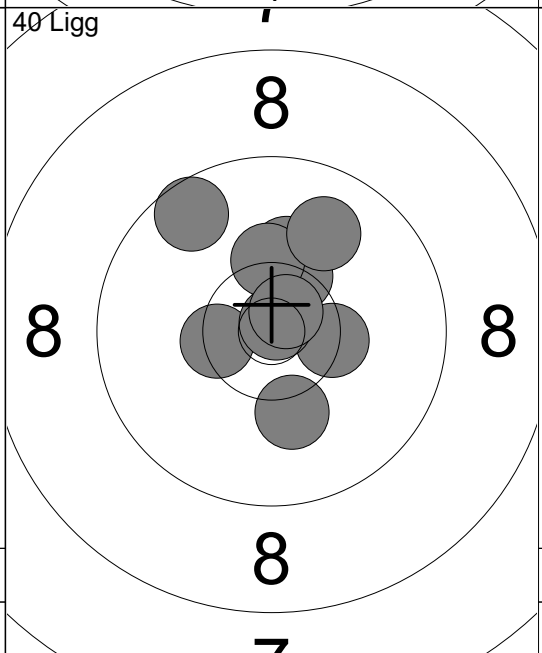

| | |
|-------------|---------|
| 11: | 10.4x ➔ |
| 12: | 9.6 ↗ |
| 13: | 10.4x ↘ |
| 14: | 10.2 ↗ |
| 15: | 10.9x ↗ |
| 16: | 10.4x ↗ |
| 17: | 10.3 ↗ |
| 18: | 10.2 ↓ |
| 19: | 9.9 ↗ |
| 20: | 10.7x ↗ |
| Serie 98.0 | |
| Total 560.0 | |

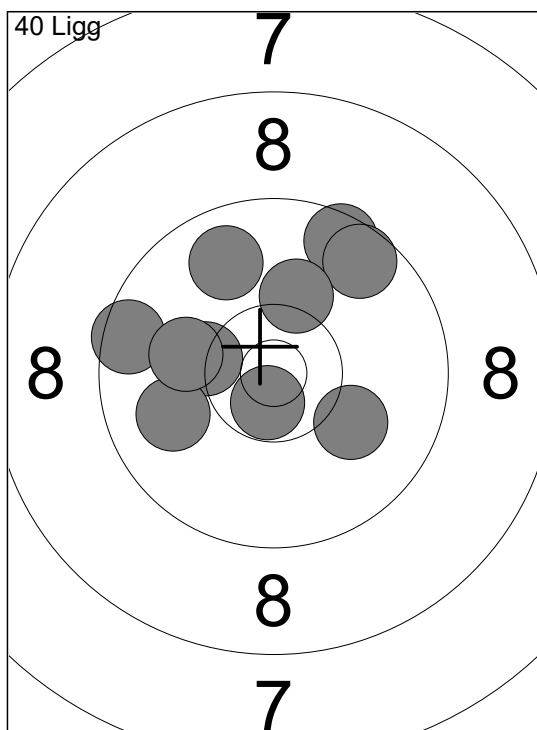

| | | |
|-------|------|-------|
| 21: | 9.6 | ↗ |
| 22: | 9.6 | ↗ |
| 23: | 9.5 | ↖ |
| 24: | 10.3 | ↖ |
| 25: | 10.2 | ↗ |
| 26: | 9.8 | ↗ |
| 27: | 9.9 | ↖ |
| 28: | 10.1 | ↖ |
| 29: | 10.1 | ↘ |
| 30: | 10.7 | ↘ |
| Serie | | 95.0 |
| Total | | 655.0 |

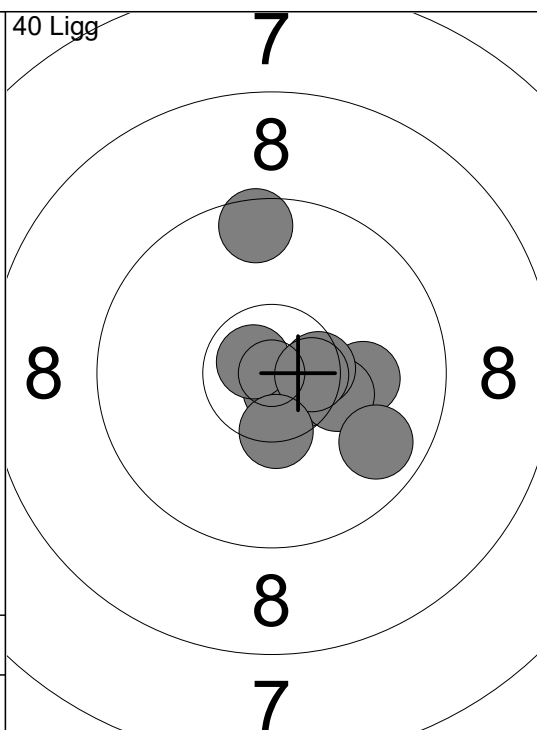

| | | |
|-------|------|-------|
| 31: | 10.8 | ↘ |
| 32: | 9.6 | ↑ |
| 33: | 10.1 | → |
| 34: | 10.6 | ↘ |
| 35: | 10.3 | ↘ |
| 36: | 10.5 | ↘ |
| 37: | 10.7 | ↖ |
| 38: | 10.6 | ↘ |
| 39: | 10.4 | ↘ |
| 40: | 9.8 | ↘ |
| Serie | | 98.0 |
| Total | | 753.0 |

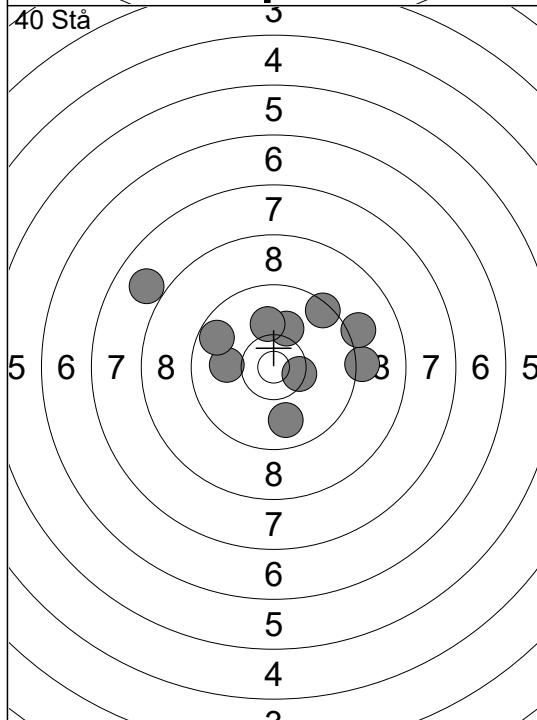

| | | |
|-------|------|-------|
| 1: | 10.0 | ↖ |
| 2: | 9.9 | ↓ |
| 3: | 9.2 | → |
| 4: | 9.1 | ↗ |
| 5: | 10.1 | ↗ |
| 6: | 9.7 | ↖ |
| 7: | 10.4 | ↘ |
| 8: | 10.1 | ↑ |
| 9: | 7.9 | ↖ |
| 10: | 9.4 | ↗ |
| Serie | | 92.0 |
| Total | | 845.0 |

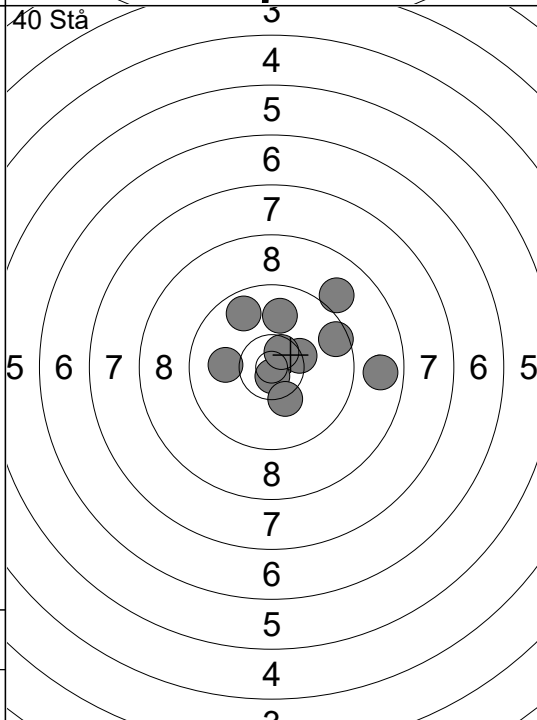

| | | |
|-------|------|-------|
| 11: | 10.0 | ↖ |
| 12: | 9.7 | ↖ |
| 13: | 9.6 | ↗ |
| 14: | 9.9 | ↑ |
| 15: | 9.0 | ↗ |
| 16: | 8.8 | → |
| 17: | 10.8 | ↘ |
| 18: | 10.4 | ↘ |
| 19: | 10.6 | ↗ |
| 20: | 10.3 | ↘ |
| Serie | | 94.0 |
| Total | | 939.0 |

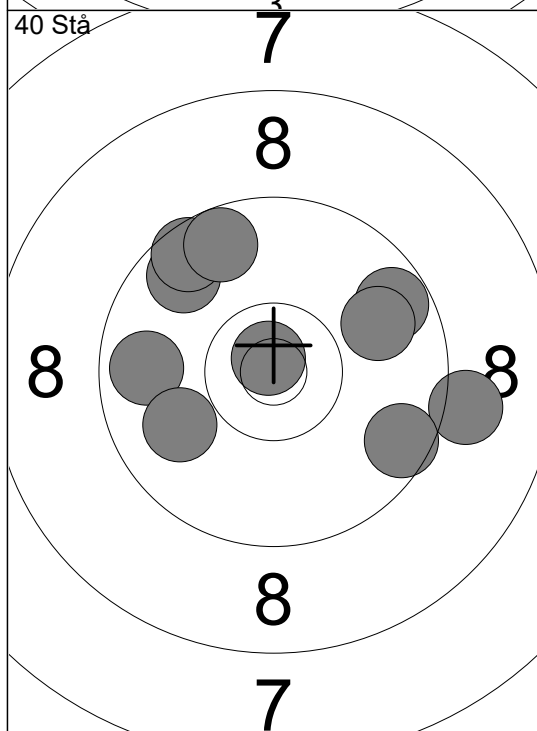

| | | |
|-------|------|--------|
| 21: | 10.8 | ↘ |
| 22: | 9.7 | ↖ |
| 23: | 9.6 | ↖ |
| 24: | 9.7 | ↗ |
| 25: | 9.8 | ↖ |
| 26: | 9.6 | ↖ |
| 27: | 9.1 | → |
| 28: | 9.6 | ↘ |
| 29: | 9.9 | ↖ |
| 30: | 9.9 | ↗ |
| Serie | | 91.0 |
| Total | | 1030.0 |

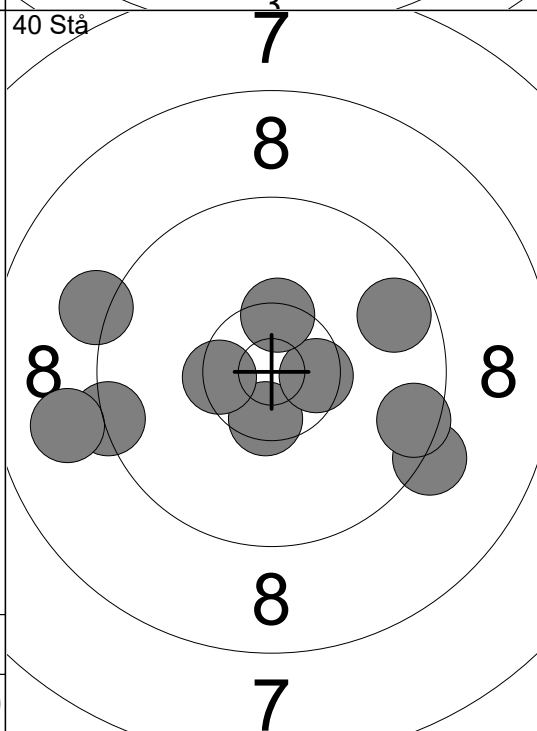

| | | |
|-------|------|--------|
| 31: | 9.3 | ↖ |
| 32: | 10.5 | ↘ |
| 33: | 10.5 | ↘ |
| 34: | 10.4 | ↗ |
| 35: | 9.2 | ↖ |
| 36: | 9.7 | ↗ |
| 37: | 10.5 | ↖ |
| 38: | 9.0 | ↖ |
| 39: | 9.2 | ↘ |
| 40: | 9.5 | ↘ |
| Serie | | 94.0 |
| Total | | 1124.0 |

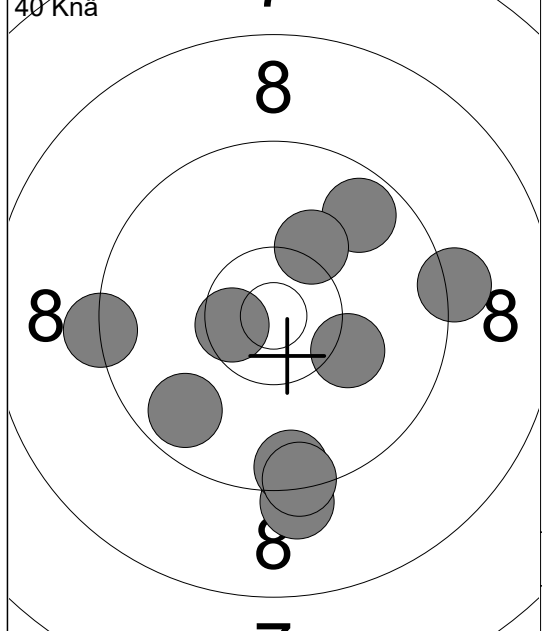

| | |
|------------|--------|
| 1: | 9.7 ↙ |
| 2: | 10.5 ✕ |
| 3: | 9.3 ← |
| 4: | 9.2 ↓ |
| 5: | 9.7 ↗ |
| 6: | 10.2 ↗ |
| 7: | 9.5 ↓ |
| 8: | 9.2 → |
| 9: | 10.2 → |
| 10: | 9.4 ↓ |
| Serie 93.0 | |
| Total 93.0 | |

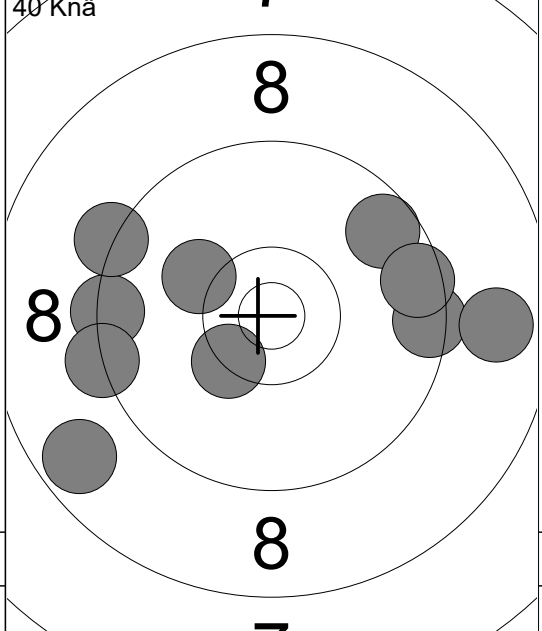

| | |
|-------------|--------|
| 11: | 9.4 ← |
| 12: | 10.2 ↖ |
| 13: | 9.3 ← |
| 14: | 9.6 ↗ |
| 15: | 10.4 ✕ |
| 16: | 8.7 ↙ |
| 17: | 9.3 ↖ |
| 18: | 9.5 → |
| 19: | 8.8 → |
| 20: | 9.5 → |
| Serie 90.0 | |
| Total 183.0 | |

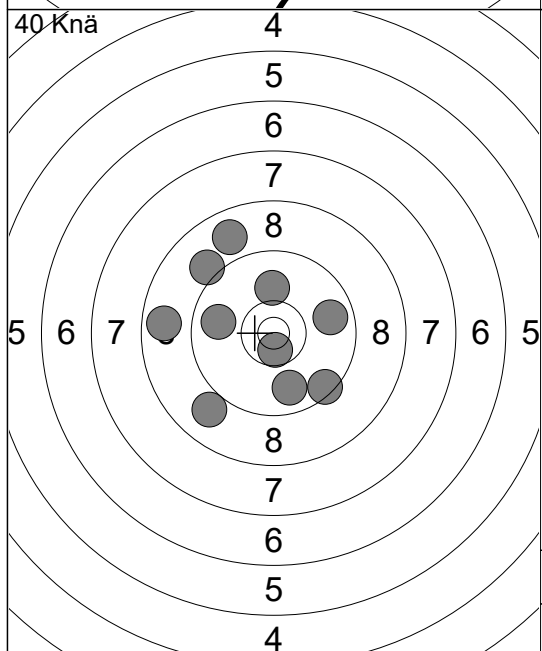

| | |
|-------------|--------|
| 21: | 9.5 ↓ |
| 22: | 9.8 → |
| 23: | 8.7 ← |
| 24: | 10.0 ↑ |
| 25: | 10.6 ✕ |
| 26: | 9.8 ← |
| 27: | 8.9 ↙ |
| 28: | 9.8 ↓ |
| 29: | 8.8 ↗ |
| 30: | 9.1 ↖ |
| Serie 89.0 | |
| Total 272.0 | |

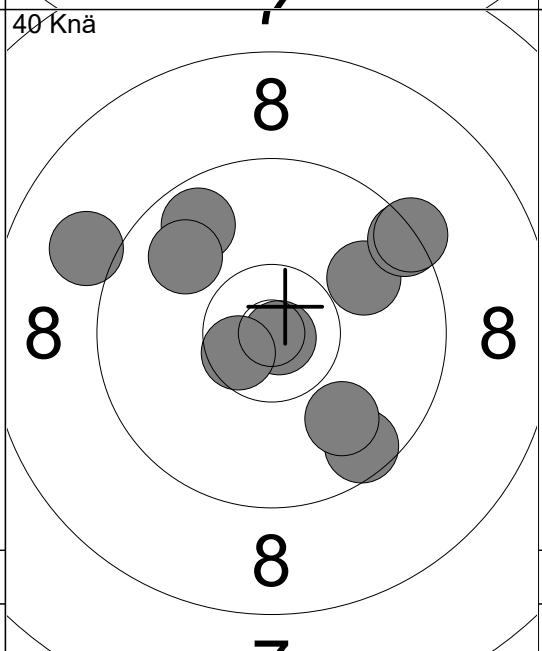

| | |
|-------------|--------|
| 31: | 9.0 ↖ |
| 32: | 10.9 ✕ |
| 33: | 9.7 ↗ |
| 34: | 9.9 ↗ |
| 35: | 9.6 ↓ |
| 36: | 9.9 ↓ |
| 37: | 9.4 ↗ |
| 38: | 9.3 ↗ |
| 39: | 10.6 ✕ |
| 40: | 9.9 ↖ |
| Serie 92.0 | |
| Total 364.0 | |

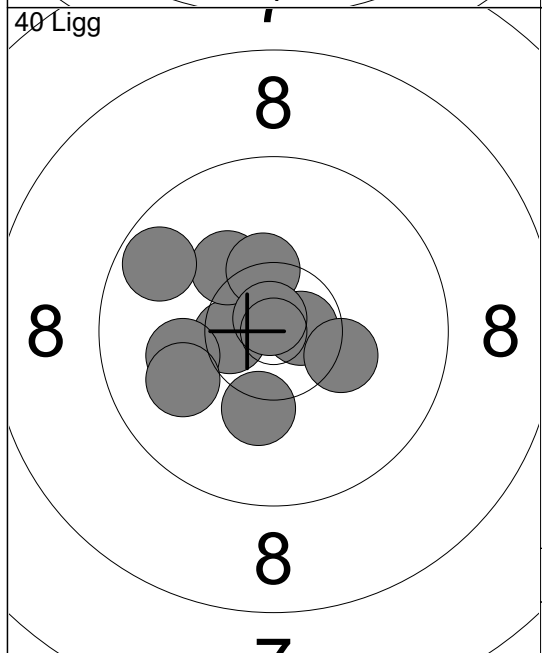

| | |
|-------------|--------|
| 1: | 10.5 ✕ |
| 2: | 10.7 ✕ |
| 3: | 10.2 ↖ |
| 4: | 10.4 ✕ |
| 5: | 9.7 ↖ |
| 6: | 10.2 ↓ |
| 7: | 10.1 ← |
| 8: | 10.0 ↙ |
| 9: | 10.3 → |
| 10: | 10.8 ✕ |
| Serie 99.0 | |
| Total 463.0 | |

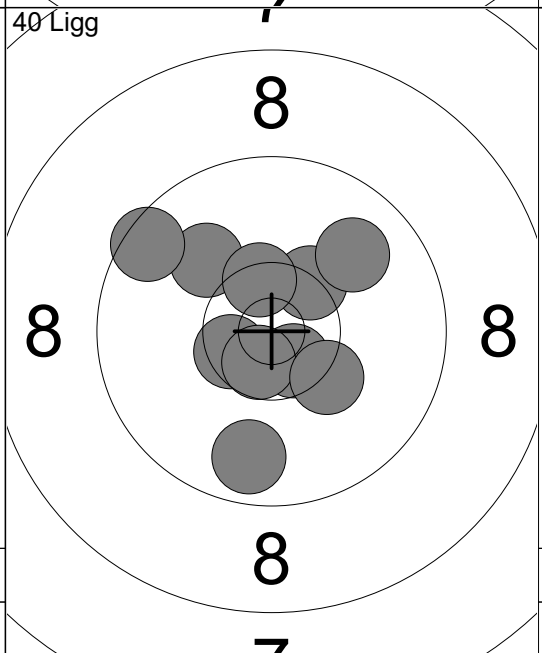

| | |
|-------------|--------|
| 11: | 10.4 ✕ |
| 12: | 9.7 ↓ |
| 13: | 10.5 ✕ |
| 14: | 10.6 ✕ |
| 15: | 10.6 ✕ |
| 16: | 10.0 ↖ |
| 17: | 9.5 ↖ |
| 18: | 10.4 ✕ |
| 19: | 9.9 ↗ |
| 20: | 10.3 ↓ |
| Serie 97.0 | |
| Total 560.0 | |

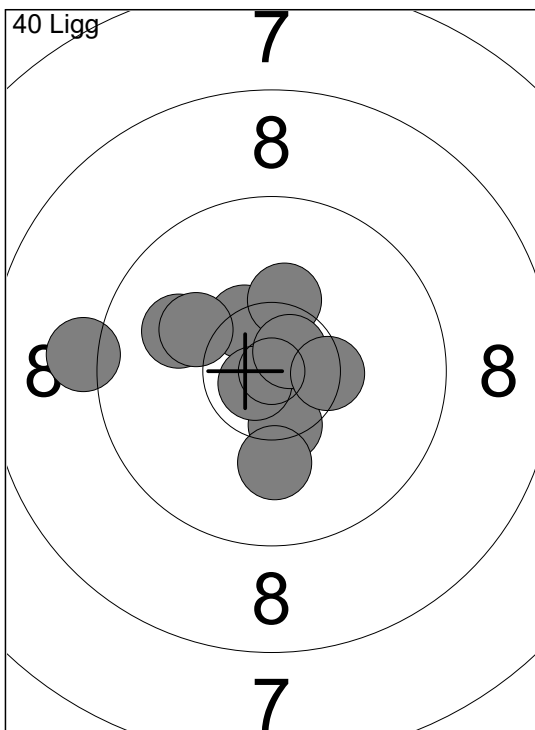

| | |
|-------|---------|
| 21: | 10.4x ↖ |
| 22: | 10.0 ↖ |
| 23: | 10.4x ↘ |
| 24: | 9.2 ← |
| 25: | 10.3 ↑ |
| 26: | 10.8x ↖ |
| 27: | 10.7x ↗ |
| 28: | 10.4x → |
| 29: | 10.1 ↓ |
| 30: | 10.1 ↖ |
| Serie | 99.0 |
| Total | 659.0 |

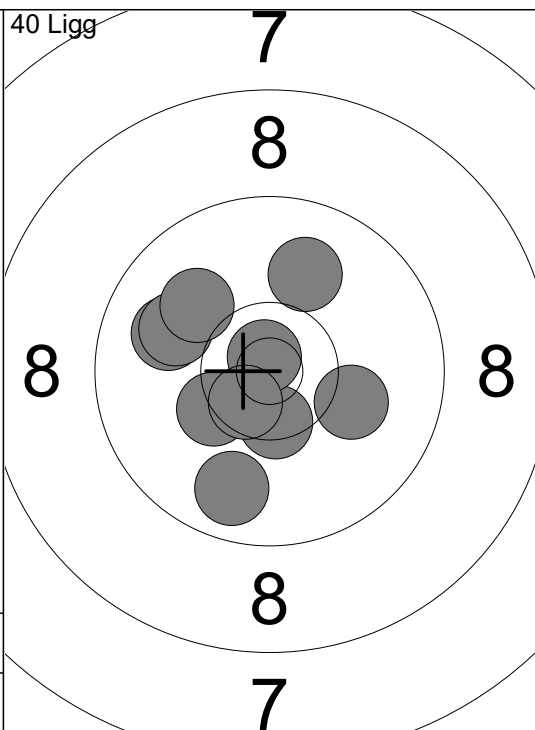

| | |
|-------|---------|
| 31: | 9.9 ← |
| 32: | 10.5x ↘ |
| 33: | 9.8 ↓ |
| 34: | 10.0 ↖ |
| 35: | 10.0 ↖ |
| 36: | 10.3x ↖ |
| 37: | 10.8x ↗ |
| 38: | 10.0 ↑ |
| 39: | 10.6x ↖ |
| 40: | 10.1 → |
| Serie | 98.0 |
| Total | 757.0 |

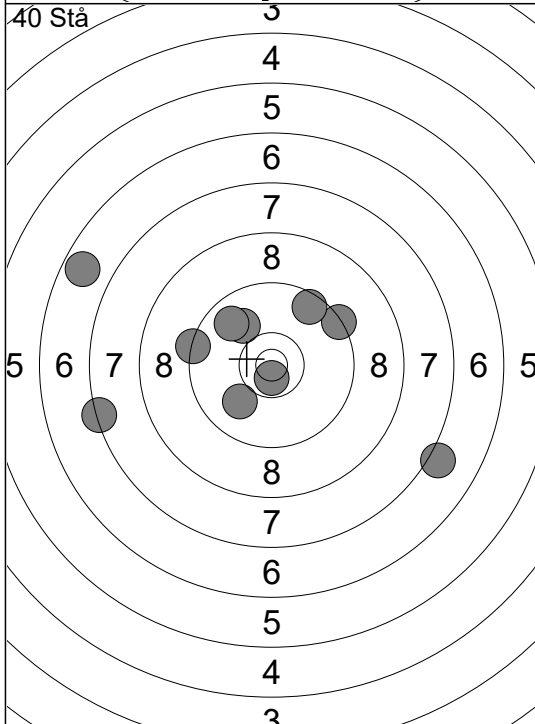

| | |
|-------|---------|
| 1: | 9.4 ↗ |
| 2: | 6.7 ↖ |
| 3: | 10.0 ↖ |
| 4: | 9.6 ↗ |
| 5: | 9.8 ↖ |
| 6: | 10.7x ↘ |
| 7: | 10.0 ↘ |
| 8: | 7.1 → |
| 9: | 7.4 ← |
| 10: | 9.3 ← |
| Serie | 86.0 |
| Total | 843.0 |

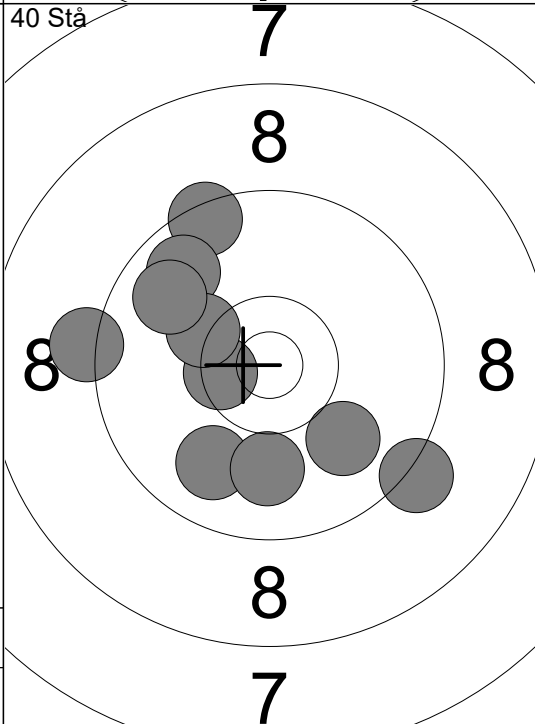

| | |
|-------|---------|
| 11: | 10.0 ↘ |
| 12: | 9.4 ↑ |
| 13: | 9.9 ↘ |
| 14: | 9.8 ↖ |
| 15: | 10.5x ↖ |
| 16: | 10.0 ↓ |
| 17: | 10.2 ↖ |
| 18: | 9.2 ← |
| 19: | 9.2 ↘ |
| 20: | 9.8 ↖ |
| Serie | 94.0 |
| Total | 937.0 |

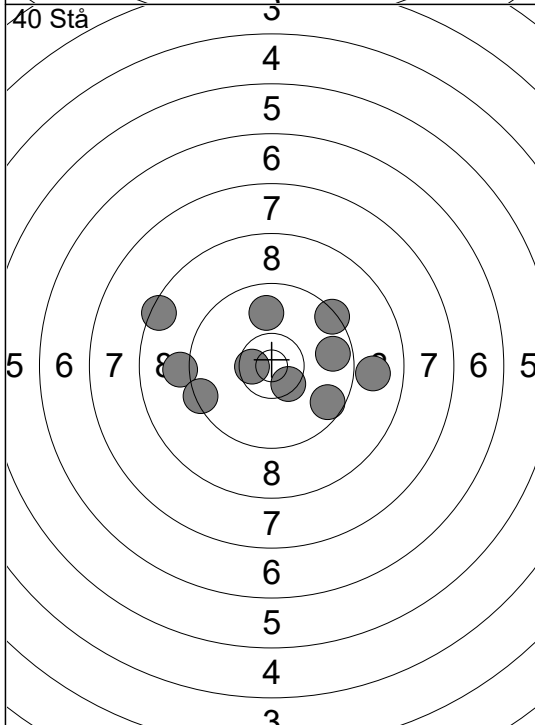

| | |
|-------|---------|
| 21: | 9.9 ↑ |
| 22: | 8.4 ↖ |
| 23: | 9.7 → |
| 24: | 10.6x ↖ |
| 25: | 9.1 ← |
| 26: | 9.4 ← |
| 27: | 10.4x ↘ |
| 28: | 9.6 ↘ |
| 29: | 8.9 → |
| 30: | 9.4 ↗ |
| Serie | 90.0 |
| Total | 1027.0 |

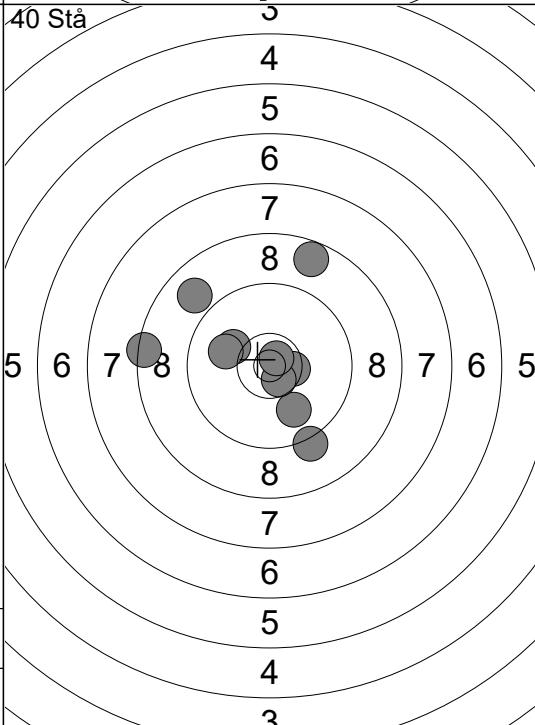

| | |
|-------|---------|
| 31: | 8.9 ↗ |
| 32: | 9.2 ↘ |
| 33: | 8.4 ← |
| 34: | 10.1 ↖ |
| 35: | 10.5x → |
| 36: | 10.0 ↖ |
| 37: | 8.7 ↑ |
| 38: | 9.9 ↘ |
| 39: | 10.6x ↘ |
| 40: | 10.8x ↗ |
| Serie | 92.0 |
| Total | 1119.0 |

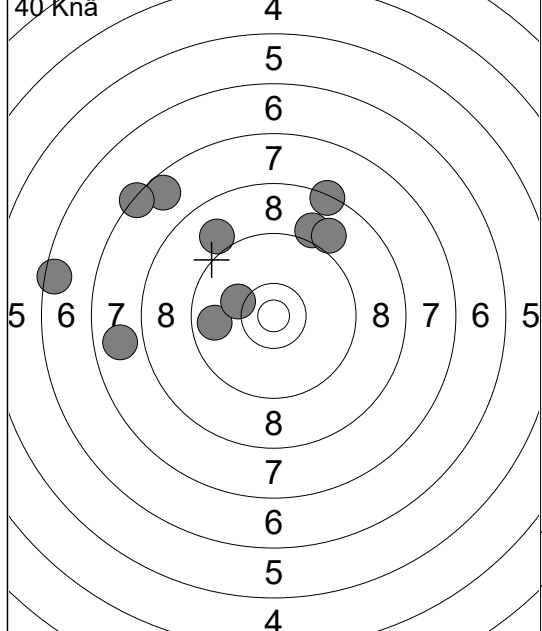

| | | |
|-------|------|------|
| 1: | 7.8 | ← |
| 2: | 7.6 | ↖ |
| 3: | 8.3 | ↗ |
| 4: | 9.0 | ↗ |
| 5: | 6.5 | ← |
| 6: | 9.8 | ← |
| 7: | 10.2 | ↖ |
| 8: | 9.1 | ↗ |
| 9: | 7.4 | ↖ |
| 10: | 9.0 | ↗ |
| Serie | | 81.0 |
| Total | | 81.0 |

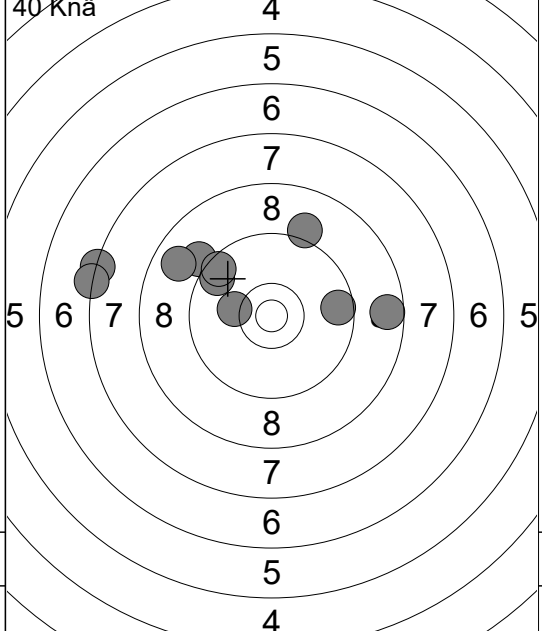

| | | |
|-------|------|-------|
| 11: | 8.6 | → |
| 12: | 9.6 | → |
| 13: | 9.1 | ↖ |
| 14: | 7.3 | ← |
| 15: | 9.6 | ↖ |
| 16: | 10.2 | ↖ |
| 17: | 8.8 | ↖ |
| 18: | 7.3 | ← |
| 19: | 9.1 | ↗ |
| 20: | 9.5 | ↖ |
| Serie | | 85.0 |
| Total | | 166.0 |

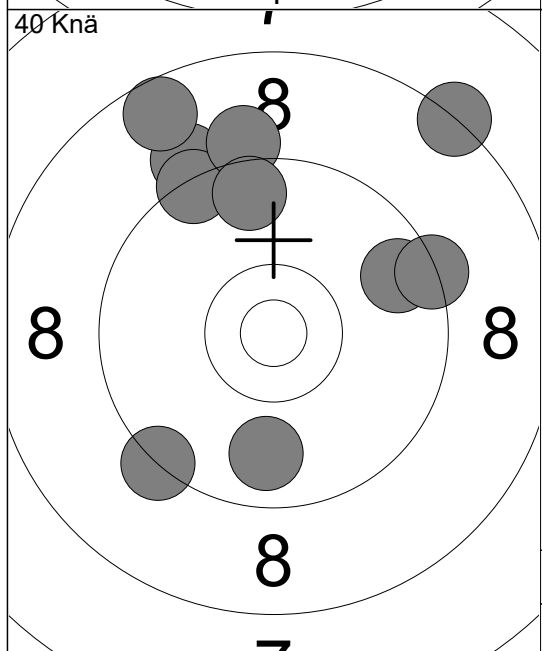

| | | |
|-------|-----|-------|
| 21: | 9.1 | ↖ |
| 22: | 8.6 | ↖ |
| 23: | 9.4 | ↖ |
| 24: | 9.1 | ↗ |
| 25: | 9.6 | ↗ |
| 26: | 9.7 | → |
| 27: | 9.8 | ↓ |
| 28: | 9.4 | → |
| 29: | 8.3 | ↗ |
| 30: | 9.3 | ↘ |
| Serie | | 88.0 |
| Total | | 254.0 |

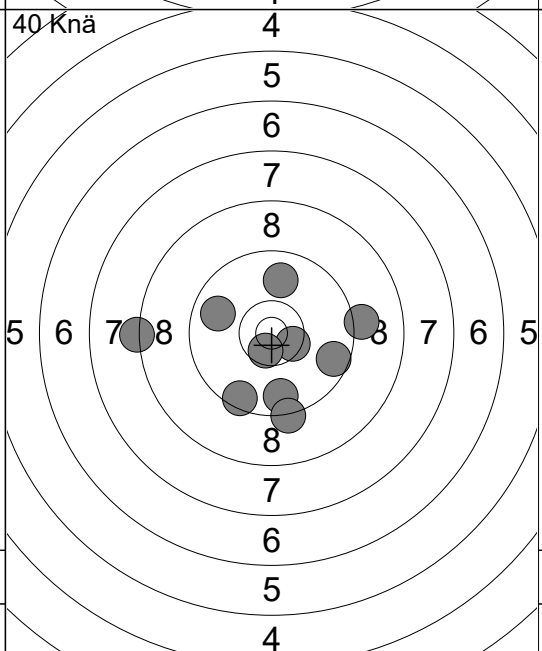

| | | |
|-------|-------|-------|
| 31: | 9.9 | ↗ |
| 32: | 9.7 | ↓ |
| 33: | 9.1 | → |
| 34: | 9.8 | ← |
| 35: | 9.3 | ↓ |
| 36: | 10.5x | ↘ |
| 37: | 9.5 | ↓ |
| 38: | 9.6 | → |
| 39: | 8.3 | ← |
| 40: | 10.6x | ↘ |
| Serie | | 91.0 |
| Total | | 345.0 |

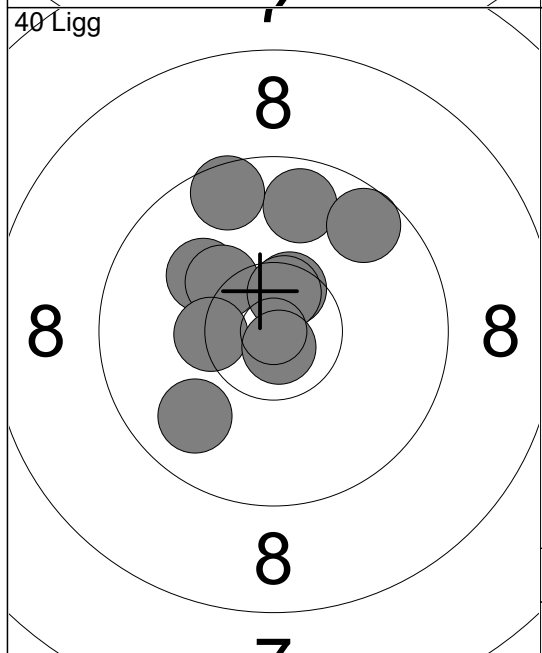

| | | |
|-------|-------|-------|
| 1: | 9.7 | ↗ |
| 2: | 9.9 | ↘ |
| 3: | 10.1 | ↖ |
| 4: | 10.3 | ↖ |
| 5: | 10.5x | ↗ |
| 6: | 9.6 | ↗ |
| 7: | 10.6x | ↗ |
| 8: | 10.4x | ← |
| 9: | 9.6 | ↗ |
| 10: | 10.8x | ↘ |
| Serie | | 96.0 |
| Total | | 441.0 |

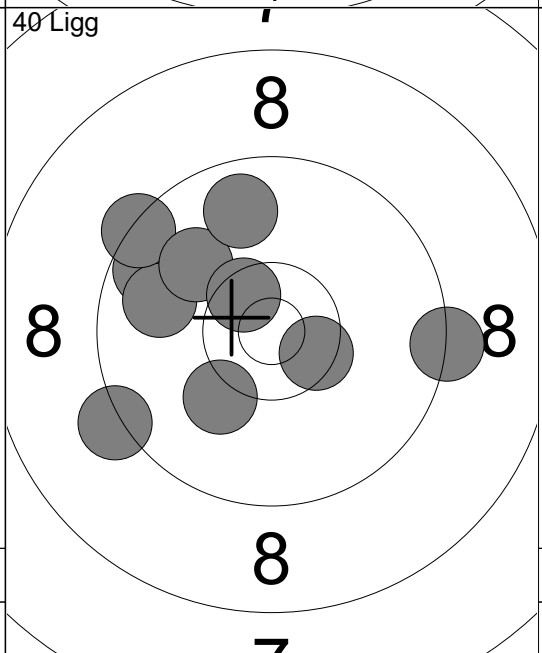

| | | |
|-------|-------|-------|
| 11: | 9.7 | ↖ |
| 12: | 9.9 | ← |
| 13: | 9.3 | → |
| 14: | 9.4 | ↖ |
| 15: | 10.0 | ↖ |
| 16: | 10.5x | ↖ |
| 17: | 10.2 | ↘ |
| 18: | 9.8 | ↗ |
| 19: | 9.2 | ← |
| 20: | 10.5x | ↘ |
| Serie | | 94.0 |
| Total | | 535.0 |

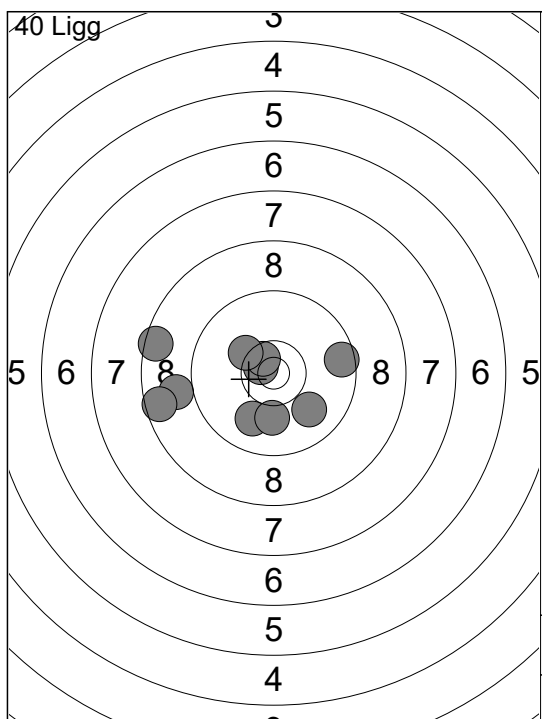

| | | |
|-------|-------|---|
| 21: | 9.6 | → |
| 22: | 10.7 | ↖ |
| 23: | 9.0 | ← |
| 24: | 10.6 | ↖ |
| 25: | 9.9 | ↓ |
| 26: | 10.1 | ↓ |
| 27: | 9.9 | ↘ |
| 28: | 10.3 | ↖ |
| 29: | 8.5 | ← |
| 30: | 8.6 | ← |
| Serie | 92.0 | |
| Total | 627.0 | |

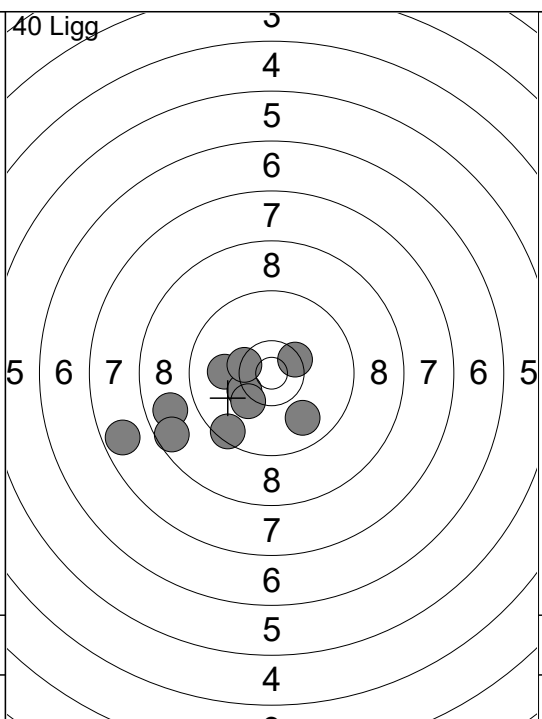

| | | |
|-------|-------|---|
| 31: | 10.4 | ↗ |
| 32: | 10.0 | ← |
| 33: | 9.5 | ↓ |
| 34: | 10.3 | ↖ |
| 35: | 10.2 | ↓ |
| 36: | 10.4 | ↖ |
| 37: | 8.8 | ← |
| 38: | 8.6 | ← |
| 39: | 7.7 | ← |
| 40: | 9.9 | ↓ |
| Serie | 91.0 | |
| Total | 718.0 | |

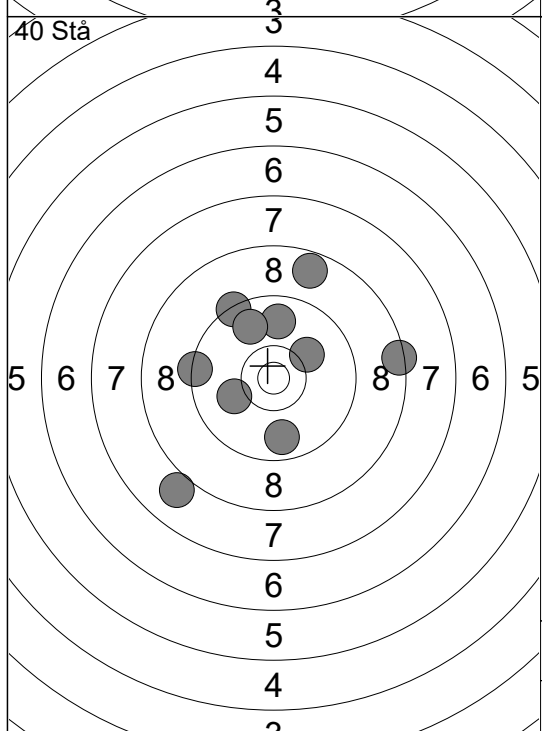

| | | |
|-------|-------|---|
| 1: | 9.8 | ↑ |
| 2: | 9.4 | ↖ |
| 3: | 8.7 | ↑ |
| 4: | 9.8 | ↑ |
| 5: | 8.4 | → |
| 6: | 9.4 | ← |
| 7: | 10.1 | ← |
| 8: | 8.0 | ↓ |
| 9: | 9.8 | ↓ |
| 10: | 10.1 | ↗ |
| Serie | 89.0 | |
| Total | 807.0 | |

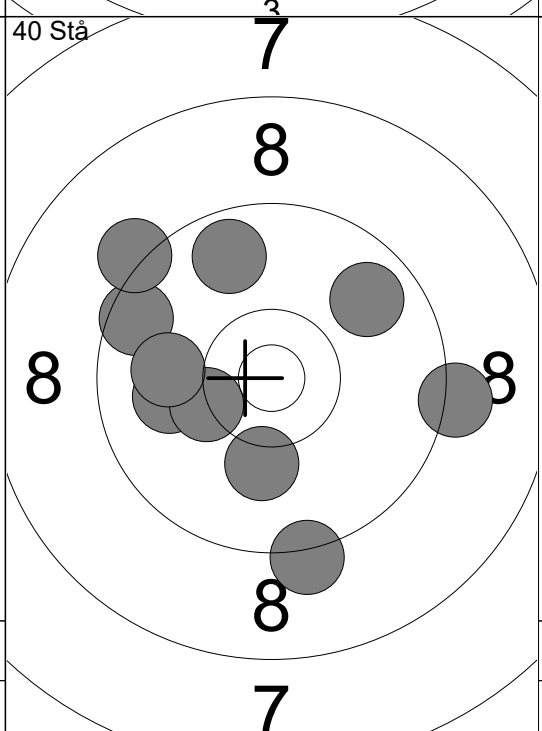

| | | |
|-------|-------|---|
| 11: | 10.1 | ↓ |
| 12: | 9.8 | ↗ |
| 13: | 9.6 | ← |
| 14: | 10.0 | ← |
| 15: | 9.7 | ↑ |
| 16: | 10.3 | ↖ |
| 17: | 10.0 | ← |
| 18: | 9.2 | → |
| 19: | 9.2 | ↓ |
| 20: | 9.2 | ↖ |
| Serie | 94.0 | |
| Total | 901.0 | |

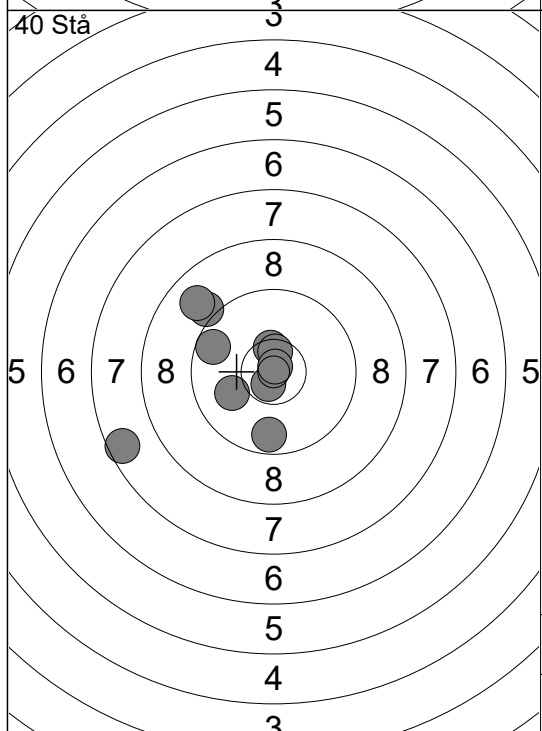

| | | |
|-------|-------|---|
| 21: | 7.6 | ← |
| 22: | 10.5 | ↗ |
| 23: | 10.7 | ↖ |
| 24: | 9.1 | ↖ |
| 25: | 10.0 | ↖ |
| 26: | 10.5 | ↗ |
| 27: | 8.9 | ↖ |
| 28: | 9.7 | ↓ |
| 29: | 9.6 | ↖ |
| 30: | 10.8 | ↗ |
| Serie | 92.0 | |
| Total | 993.0 | |

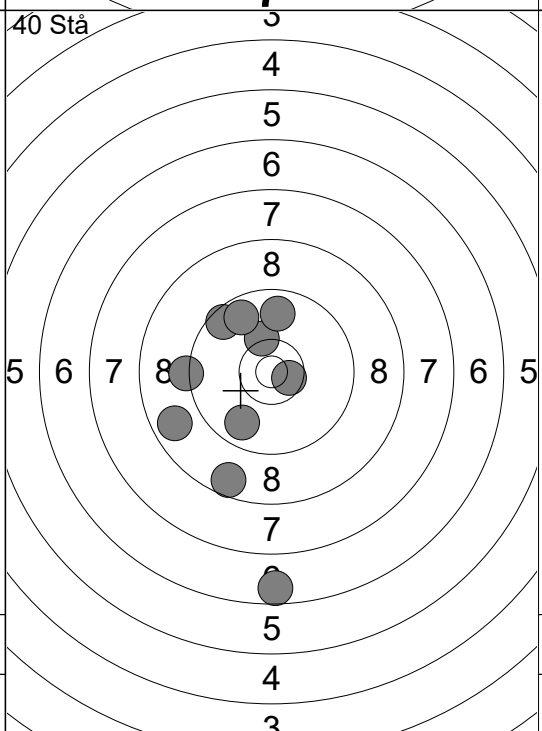

| | | |
|-------|--------|---|
| 31: | 9.2 | ← |
| 32: | 10.3 | ↑ |
| 33: | 8.7 | ← |
| 34: | 9.6 | ↖ |
| 35: | 9.7 | ↖ |
| 36: | 6.6 | ↓ |
| 37: | 8.6 | ↓ |
| 38: | 10.6 | ↖ |
| 39: | 9.8 | ↓ |
| 40: | 9.8 | ↑ |
| Serie | 87.0 | |
| Total | 1080.0 | |

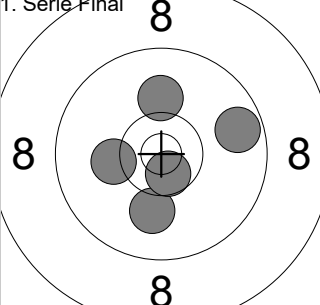
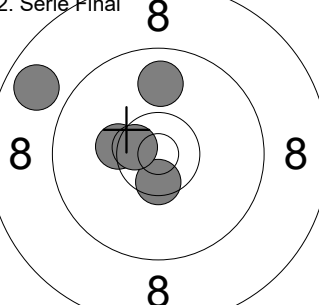
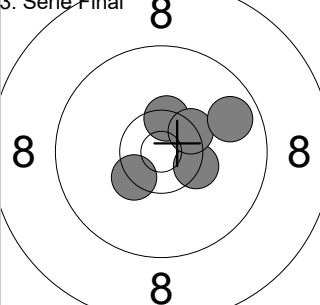
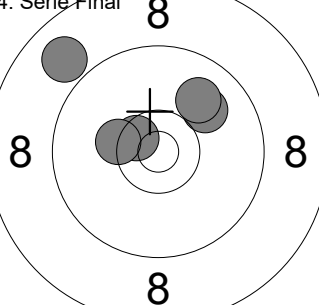
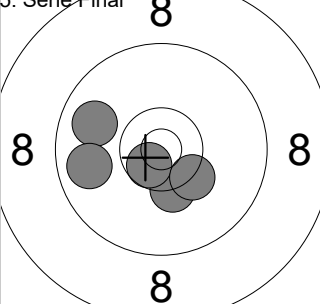
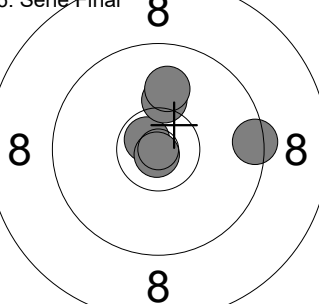
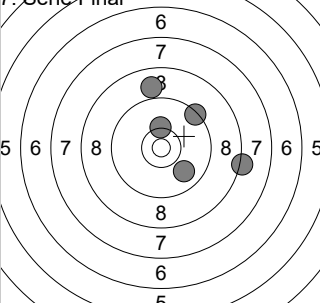
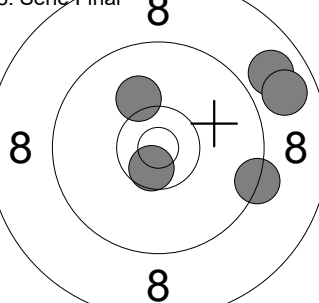
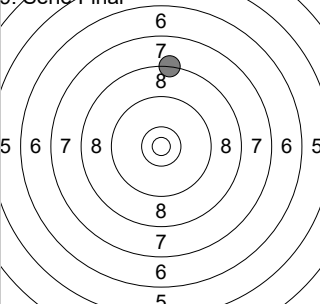
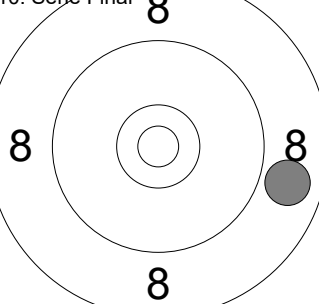
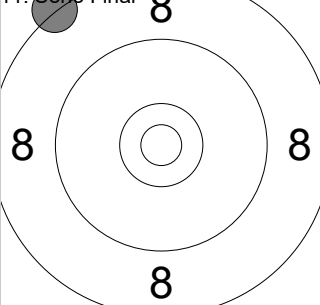
| | | | | | | | | | | | | | | | | | | | | | | | | | | | | | | | | | |
|--|--|-------|-------|-------|--|--|--|-------|-------|-------|-------|-------|---|----|-------|---|---|--|----|-------|---|----|-------|---|----|-------|---|----|-------|---|----|-------|---|
| 1. Serie Final  | <table style="width:100%; border-collapse: collapse;"> <tr><td>1:</td><td>10.2</td><td>←</td></tr> <tr><td>2:</td><td>10.1</td><td>↓</td></tr> <tr><td>3:</td><td>10.1</td><td>↑</td></tr> <tr><td>4:</td><td>9.7</td><td>→</td></tr> <tr><td>5:</td><td>10.6x</td><td>↓</td></tr> </table> | 1: | 10.2 | ← | 2: | 10.1 | ↓ | 3: | 10.1 | ↑ | 4: | 9.7 | → | 5: | 10.6x | ↓ | 2. Serie Final  | <table style="width:100%; border-collapse: collapse;"> <tr><td>1:</td><td>8.8</td><td>↖</td></tr> <tr><td>2:</td><td>10.5x</td><td>↓</td></tr> <tr><td>3:</td><td>10.3x</td><td>←</td></tr> <tr><td>4:</td><td>10.6x</td><td>←</td></tr> <tr><td>5:</td><td>9.9</td><td>↑</td></tr> </table> | 1: | 8.8 | ↖ | 2: | 10.5x | ↓ | 3: | 10.3x | ← | 4: | 10.6x | ← | 5: | 9.9 | ↑ |
| 1: | 10.2 | ← | | | | | | | | | | | | | | | | | | | | | | | | | | | | | | | |
| 2: | 10.1 | ↓ | | | | | | | | | | | | | | | | | | | | | | | | | | | | | | | |
| 3: | 10.1 | ↑ | | | | | | | | | | | | | | | | | | | | | | | | | | | | | | | |
| 4: | 9.7 | → | | | | | | | | | | | | | | | | | | | | | | | | | | | | | | | |
| 5: | 10.6x | ↓ | | | | | | | | | | | | | | | | | | | | | | | | | | | | | | | |
| 1: | 8.8 | ↖ | | | | | | | | | | | | | | | | | | | | | | | | | | | | | | | |
| 2: | 10.5x | ↓ | | | | | | | | | | | | | | | | | | | | | | | | | | | | | | | |
| 3: | 10.3x | ← | | | | | | | | | | | | | | | | | | | | | | | | | | | | | | | |
| 4: | 10.6x | ← | | | | | | | | | | | | | | | | | | | | | | | | | | | | | | | |
| 5: | 9.9 | ↑ | | | | | | | | | | | | | | | | | | | | | | | | | | | | | | | |
| | <table style="width:100%; border-collapse: collapse;"> <tr><td style="border-bottom: 1px solid black;">Serie</td><td style="border-bottom: 1px solid black; text-align: right;">50.7</td></tr> <tr><td style="border-bottom: 1px solid black;">Total</td><td style="border-bottom: 1px solid black; text-align: right;">50.7</td></tr> </table> | Serie | 50.7 | Total | 50.7 | | <table style="width:100%; border-collapse: collapse;"> <tr><td style="border-bottom: 1px solid black;">Serie</td><td style="border-bottom: 1px solid black; text-align: right;">50.1</td></tr> <tr><td style="border-bottom: 1px solid black;">Total</td><td style="border-bottom: 1px solid black; text-align: right;">100.8</td></tr> </table> | Serie | 50.1 | Total | 100.8 | | | | | | | | | | | | | | | | | | | | | | |
| Serie | 50.7 | | | | | | | | | | | | | | | | | | | | | | | | | | | | | | | | |
| Total | 50.7 | | | | | | | | | | | | | | | | | | | | | | | | | | | | | | | | |
| Serie | 50.1 | | | | | | | | | | | | | | | | | | | | | | | | | | | | | | | | |
| Total | 100.8 | | | | | | | | | | | | | | | | | | | | | | | | | | | | | | | | |
| 3. Serie Final  | <table style="width:100%; border-collapse: collapse;"> <tr><td>1:</td><td>10.4x</td><td>↙</td></tr> <tr><td>2:</td><td>10.4x</td><td>→</td></tr> <tr><td>3:</td><td>10.4x</td><td>↑</td></tr> <tr><td>4:</td><td>10.4x</td><td>↗</td></tr> <tr><td>5:</td><td>9.8</td><td>↗</td></tr> </table> | 1: | 10.4x | ↙ | 2: | 10.4x | → | 3: | 10.4x | ↑ | 4: | 10.4x | ↗ | 5: | 9.8 | ↗ | 4. Serie Final  | <table style="width:100%; border-collapse: collapse;"> <tr><td>1:</td><td>8.9</td><td>↖</td></tr> <tr><td>2:</td><td>10.0</td><td>↗</td></tr> <tr><td>3:</td><td>9.9</td><td>↗</td></tr> <tr><td>4:</td><td>10.5x</td><td>↗</td></tr> <tr><td>5:</td><td>10.3x</td><td>←</td></tr> </table> | 1: | 8.9 | ↖ | 2: | 10.0 | ↗ | 3: | 9.9 | ↗ | 4: | 10.5x | ↗ | 5: | 10.3x | ← |
| 1: | 10.4x | ↙ | | | | | | | | | | | | | | | | | | | | | | | | | | | | | | | |
| 2: | 10.4x | → | | | | | | | | | | | | | | | | | | | | | | | | | | | | | | | |
| 3: | 10.4x | ↑ | | | | | | | | | | | | | | | | | | | | | | | | | | | | | | | |
| 4: | 10.4x | ↗ | | | | | | | | | | | | | | | | | | | | | | | | | | | | | | | |
| 5: | 9.8 | ↗ | | | | | | | | | | | | | | | | | | | | | | | | | | | | | | | |
| 1: | 8.9 | ↖ | | | | | | | | | | | | | | | | | | | | | | | | | | | | | | | |
| 2: | 10.0 | ↗ | | | | | | | | | | | | | | | | | | | | | | | | | | | | | | | |
| 3: | 9.9 | ↗ | | | | | | | | | | | | | | | | | | | | | | | | | | | | | | | |
| 4: | 10.5x | ↗ | | | | | | | | | | | | | | | | | | | | | | | | | | | | | | | |
| 5: | 10.3x | ← | | | | | | | | | | | | | | | | | | | | | | | | | | | | | | | |
| | <table style="width:100%; border-collapse: collapse;"> <tr><td style="border-bottom: 1px solid black;">Serie</td><td style="border-bottom: 1px solid black; text-align: right;">51.4</td></tr> <tr><td style="border-bottom: 1px solid black;">Total</td><td style="border-bottom: 1px solid black; text-align: right;">152.2</td></tr> </table> | Serie | 51.4 | Total | 152.2 | | <table style="width:100%; border-collapse: collapse;"> <tr><td style="border-bottom: 1px solid black;">Serie</td><td style="border-bottom: 1px solid black; text-align: right;">49.6</td></tr> <tr><td style="border-bottom: 1px solid black;">Total</td><td style="border-bottom: 1px solid black; text-align: right;">201.8</td></tr> </table> | Serie | 49.6 | Total | 201.8 | | | | | | | | | | | | | | | | | | | | | | |
| Serie | 51.4 | | | | | | | | | | | | | | | | | | | | | | | | | | | | | | | | |
| Total | 152.2 | | | | | | | | | | | | | | | | | | | | | | | | | | | | | | | | |
| Serie | 49.6 | | | | | | | | | | | | | | | | | | | | | | | | | | | | | | | | |
| Total | 201.8 | | | | | | | | | | | | | | | | | | | | | | | | | | | | | | | | |
| 5. Serie Final  | <table style="width:100%; border-collapse: collapse;"> <tr><td>1:</td><td>9.8</td><td>←</td></tr> <tr><td>2:</td><td>9.8</td><td>←</td></tr> <tr><td>3:</td><td>10.3x</td><td>↓</td></tr> <tr><td>4:</td><td>10.6x</td><td>↓</td></tr> <tr><td>5:</td><td>10.3x</td><td>↓</td></tr> </table> | 1: | 9.8 | ← | 2: | 9.8 | ← | 3: | 10.3x | ↓ | 4: | 10.6x | ↓ | 5: | 10.3x | ↓ | 6. Serie Final  | <table style="width:100%; border-collapse: collapse;"> <tr><td>1:</td><td>10.7x</td><td>↖</td></tr> <tr><td>2:</td><td>10.9x</td><td>↓</td></tr> <tr><td>3:</td><td>9.4</td><td>→</td></tr> <tr><td>4:</td><td>10.2</td><td>↑</td></tr> <tr><td>5:</td><td>10.0</td><td>↑</td></tr> </table> | 1: | 10.7x | ↖ | 2: | 10.9x | ↓ | 3: | 9.4 | → | 4: | 10.2 | ↑ | 5: | 10.0 | ↑ |
| 1: | 9.8 | ← | | | | | | | | | | | | | | | | | | | | | | | | | | | | | | | |
| 2: | 9.8 | ← | | | | | | | | | | | | | | | | | | | | | | | | | | | | | | | |
| 3: | 10.3x | ↓ | | | | | | | | | | | | | | | | | | | | | | | | | | | | | | | |
| 4: | 10.6x | ↓ | | | | | | | | | | | | | | | | | | | | | | | | | | | | | | | |
| 5: | 10.3x | ↓ | | | | | | | | | | | | | | | | | | | | | | | | | | | | | | | |
| 1: | 10.7x | ↖ | | | | | | | | | | | | | | | | | | | | | | | | | | | | | | | |
| 2: | 10.9x | ↓ | | | | | | | | | | | | | | | | | | | | | | | | | | | | | | | |
| 3: | 9.4 | → | | | | | | | | | | | | | | | | | | | | | | | | | | | | | | | |
| 4: | 10.2 | ↑ | | | | | | | | | | | | | | | | | | | | | | | | | | | | | | | |
| 5: | 10.0 | ↑ | | | | | | | | | | | | | | | | | | | | | | | | | | | | | | | |
| | <table style="width:100%; border-collapse: collapse;"> <tr><td style="border-bottom: 1px solid black;">Serie</td><td style="border-bottom: 1px solid black; text-align: right;">50.8</td></tr> <tr><td style="border-bottom: 1px solid black;">Total</td><td style="border-bottom: 1px solid black; text-align: right;">252.6</td></tr> </table> | Serie | 50.8 | Total | 252.6 | | <table style="width:100%; border-collapse: collapse;"> <tr><td style="border-bottom: 1px solid black;">Serie</td><td style="border-bottom: 1px solid black; text-align: right;">51.2</td></tr> <tr><td style="border-bottom: 1px solid black;">Total</td><td style="border-bottom: 1px solid black; text-align: right;">303.8</td></tr> </table> | Serie | 51.2 | Total | 303.8 | | | | | | | | | | | | | | | | | | | | | | |
| Serie | 50.8 | | | | | | | | | | | | | | | | | | | | | | | | | | | | | | | | |
| Total | 252.6 | | | | | | | | | | | | | | | | | | | | | | | | | | | | | | | | |
| Serie | 51.2 | | | | | | | | | | | | | | | | | | | | | | | | | | | | | | | | |
| Total | 303.8 | | | | | | | | | | | | | | | | | | | | | | | | | | | | | | | | |
| 7. Serie Final  | <table style="width:100%; border-collapse: collapse;"> <tr><td>1:</td><td>8.9</td><td>↑</td></tr> <tr><td>2:</td><td>9.4</td><td>↗</td></tr> <tr><td>3:</td><td>8.2</td><td>↗</td></tr> <tr><td>4:</td><td>10.3</td><td>↑</td></tr> <tr><td>5:</td><td>9.9</td><td>↓</td></tr> </table> | 1: | 8.9 | ↑ | 2: | 9.4 | ↗ | 3: | 8.2 | ↗ | 4: | 10.3 | ↑ | 5: | 9.9 | ↓ | 8. Serie Final  | <table style="width:100%; border-collapse: collapse;"> <tr><td>1:</td><td>8.8</td><td>↗</td></tr> <tr><td>2:</td><td>10.6x</td><td>↓</td></tr> <tr><td>3:</td><td>9.3</td><td>↓</td></tr> <tr><td>4:</td><td>8.8</td><td>→</td></tr> <tr><td>5:</td><td>10.1</td><td>↑</td></tr> </table> | 1: | 8.8 | ↗ | 2: | 10.6x | ↓ | 3: | 9.3 | ↓ | 4: | 8.8 | → | 5: | 10.1 | ↑ |
| 1: | 8.9 | ↑ | | | | | | | | | | | | | | | | | | | | | | | | | | | | | | | |
| 2: | 9.4 | ↗ | | | | | | | | | | | | | | | | | | | | | | | | | | | | | | | |
| 3: | 8.2 | ↗ | | | | | | | | | | | | | | | | | | | | | | | | | | | | | | | |
| 4: | 10.3 | ↑ | | | | | | | | | | | | | | | | | | | | | | | | | | | | | | | |
| 5: | 9.9 | ↓ | | | | | | | | | | | | | | | | | | | | | | | | | | | | | | | |
| 1: | 8.8 | ↗ | | | | | | | | | | | | | | | | | | | | | | | | | | | | | | | |
| 2: | 10.6x | ↓ | | | | | | | | | | | | | | | | | | | | | | | | | | | | | | | |
| 3: | 9.3 | ↓ | | | | | | | | | | | | | | | | | | | | | | | | | | | | | | | |
| 4: | 8.8 | → | | | | | | | | | | | | | | | | | | | | | | | | | | | | | | | |
| 5: | 10.1 | ↑ | | | | | | | | | | | | | | | | | | | | | | | | | | | | | | | |
| | <table style="width:100%; border-collapse: collapse;"> <tr><td style="border-bottom: 1px solid black;">Serie</td><td style="border-bottom: 1px solid black; text-align: right;">46.7</td></tr> <tr><td style="border-bottom: 1px solid black;">Total</td><td style="border-bottom: 1px solid black; text-align: right;">350.5</td></tr> </table> | Serie | 46.7 | Total | 350.5 | | <table style="width:100%; border-collapse: collapse;"> <tr><td style="border-bottom: 1px solid black;">Serie</td><td style="border-bottom: 1px solid black; text-align: right;">47.6</td></tr> <tr><td style="border-bottom: 1px solid black;">Total</td><td style="border-bottom: 1px solid black; text-align: right;">398.1</td></tr> </table> | Serie | 47.6 | Total | 398.1 | | | | | | | | | | | | | | | | | | | | | | |
| Serie | 46.7 | | | | | | | | | | | | | | | | | | | | | | | | | | | | | | | | |
| Total | 350.5 | | | | | | | | | | | | | | | | | | | | | | | | | | | | | | | | |
| Serie | 47.6 | | | | | | | | | | | | | | | | | | | | | | | | | | | | | | | | |
| Total | 398.1 | | | | | | | | | | | | | | | | | | | | | | | | | | | | | | | | |
| 9. Serie Final  | <table style="width:100%; border-collapse: collapse;"> <tr><td>1:</td><td>8.3</td><td>↑</td></tr> </table> | 1: | 8.3 | ↑ | 10. Serie Final  | <table style="width:100%; border-collapse: collapse;"> <tr><td>1:</td><td>8.9</td><td>→</td></tr> </table> | 1: | 8.9 | → | | | | | | | | | | | | | | | | | | | | | | | | |
| 1: | 8.3 | ↑ | | | | | | | | | | | | | | | | | | | | | | | | | | | | | | | |
| 1: | 8.9 | → | | | | | | | | | | | | | | | | | | | | | | | | | | | | | | | |
| | <table style="width:100%; border-collapse: collapse;"> <tr><td style="border-bottom: 1px solid black;">Serie</td><td style="border-bottom: 1px solid black; text-align: right;">8.3</td></tr> <tr><td style="border-bottom: 1px solid black;">Total</td><td style="border-bottom: 1px solid black; text-align: right;">406.4</td></tr> </table> | Serie | 8.3 | Total | 406.4 | | <table style="width:100%; border-collapse: collapse;"> <tr><td style="border-bottom: 1px solid black;">Serie</td><td style="border-bottom: 1px solid black; text-align: right;">8.9</td></tr> <tr><td style="border-bottom: 1px solid black;">Total</td><td style="border-bottom: 1px solid black; text-align: right;">415.3</td></tr> </table> | Serie | 8.9 | Total | 415.3 | | | | | | | | | | | | | | | | | | | | | | |
| Serie | 8.3 | | | | | | | | | | | | | | | | | | | | | | | | | | | | | | | | |
| Total | 406.4 | | | | | | | | | | | | | | | | | | | | | | | | | | | | | | | | |
| Serie | 8.9 | | | | | | | | | | | | | | | | | | | | | | | | | | | | | | | | |
| Total | 415.3 | | | | | | | | | | | | | | | | | | | | | | | | | | | | | | | | |
| 11. Serie Final  | <table style="width:100%; border-collapse: collapse;"> <tr><td>1:</td><td>8.3</td><td>↖</td></tr> </table> | 1: | 8.3 | ↖ | | | | | | | | | | | | | | | | | | | | | | | | | | | | | |
| 1: | 8.3 | ↖ | | | | | | | | | | | | | | | | | | | | | | | | | | | | | | | |
| | <table style="width:100%; border-collapse: collapse;"> <tr><td style="border-bottom: 1px solid black;">Serie</td><td style="border-bottom: 1px solid black; text-align: right;">8.3</td></tr> <tr><td style="border-bottom: 1px solid black;">Total</td><td style="border-bottom: 1px solid black; text-align: right;">423.6</td></tr> </table> | Serie | 8.3 | Total | 423.6 | | | | | | | | | | | | | | | | | | | | | | | | | | | | |
| Serie | 8.3 | | | | | | | | | | | | | | | | | | | | | | | | | | | | | | | | |
| Total | 423.6 | | | | | | | | | | | | | | | | | | | | | | | | | | | | | | | | |

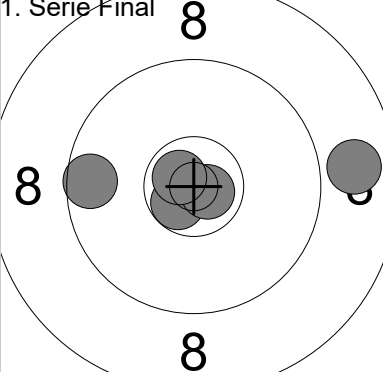
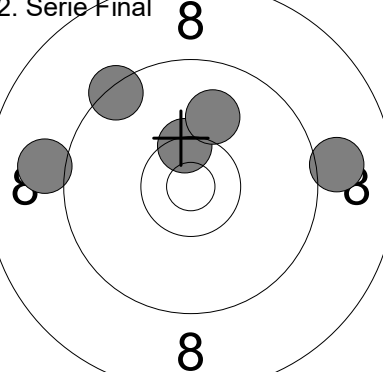
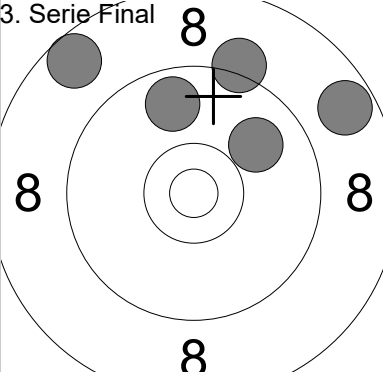
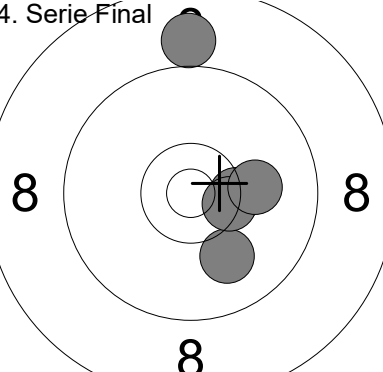
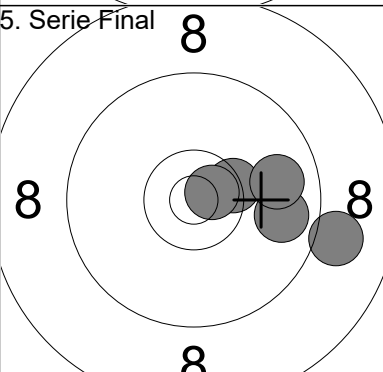
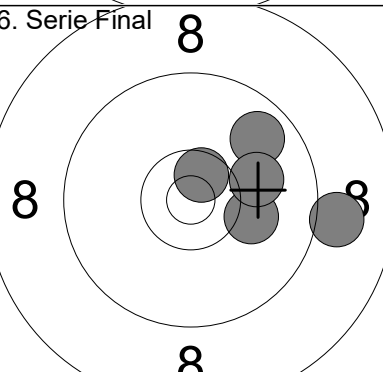
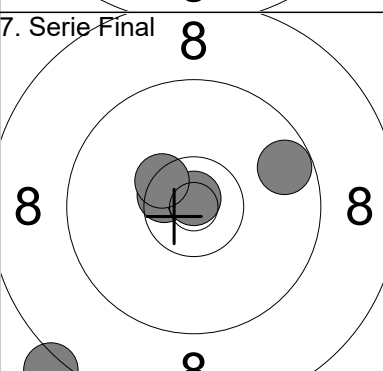
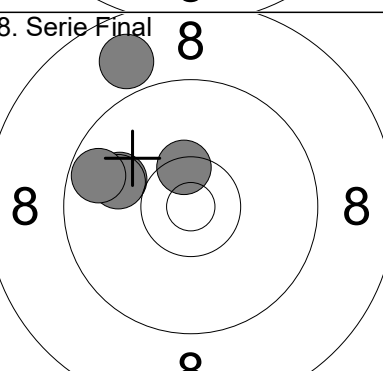
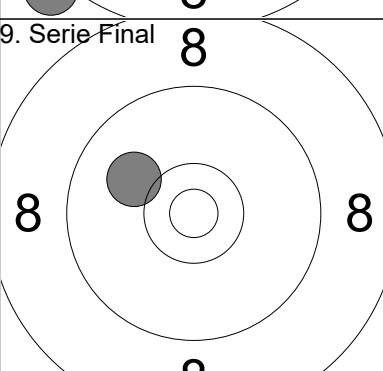
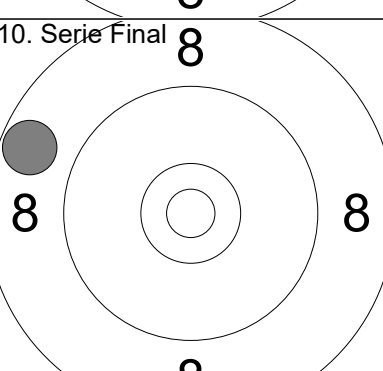
| | | | |
|---|---|--|---|
| 1. Serie Final  | 1: 10.7x ↙ 2: 9.6 ← 3: 8.9 → 4: 10.8x ↘ 5: 10.7x ↗ <hr/> Serie 50.7 Total 50.7 | 2. Serie Final  | 1: 9.4 ↗ 2: 10.4x ↑ 3: 9.0 ← 4: 10.0 ↗ 5: 9.0 → <hr/> Serie 47.8 Total 98.5 |
| 3. Serie Final  | 1: 8.6 ↗ 2: 8.7 ↗ 3: 9.2 ↗ 4: 9.8 ↗ 5: 9.9 ↗ <hr/> Serie 46.2 Total 144.7 | 4. Serie Final  | 1: 10.4x → 2: 10.0 ↘ 3: 10.4x → 4: 10.1 → 5: 9.0 ↑ <hr/> Serie 49.9 Total 194.6 |
| 5. Serie Final  | 1: 9.8 → 2: 10.4x → 3: 10.7x → 4: 9.8 → 5: 9.0 → <hr/> Serie 49.7 Total 244.3 | 6. Serie Final  | 1: 10.6x ↑ 2: 9.8 ↗ 3: 10.1 → 4: 10.1 → 5: 9.0 → <hr/> Serie 49.6 Total 293.9 |
| 7. Serie Final  | 1: 10.5x ← 2: 10.8x ↑ 3: 9.7 → 4: 10.4x ↗ 5: 8.1 ↙ <hr/> Serie 49.5 Total 343.4 | 8. Serie Final  | 1: 10.0 ↙ 2: 10.0 ↙ 3: 10.4x ↑ 4: 8.9 ↗ 5: 9.7 ↙ <hr/> Serie 49.0 Total 392.4 |
| 9. Serie Final  | 1: 10.1 ↙ <hr/> Serie 10.1 Total 402.5 | 10. Serie Final  | 1: 8.7 ↙ <hr/> Serie 8.7 Total 411.2 |

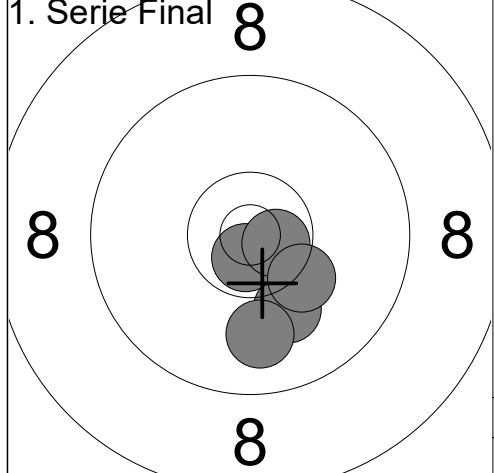

| | | |
|-------|-------|------|
| 1: | 10.1 | ↘ |
| 2: | 10.7x | ↘ |
| 3: | 9.9 | ↘ |
| 4: | 10.7x | → |
| 5: | 10.3 | ↘ |
| Serie | | 51.7 |
| Total | | 51.7 |

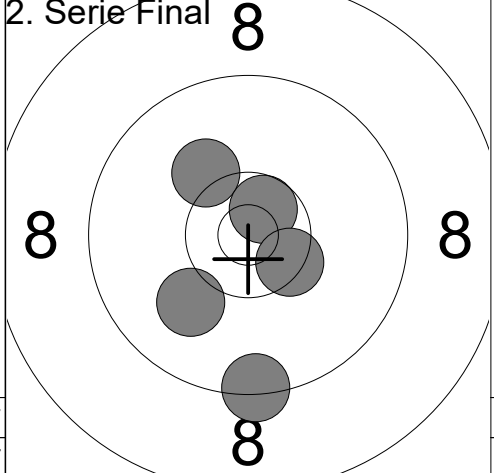

| | | |
|-------|-------|-------|
| 1: | 10.0 | ↘ |
| 2: | 9.4 | ↘ |
| 3: | 10.2 | ↗ |
| 4: | 10.6x | ↗ |
| 5: | 10.4x | ↘ |
| Serie | | 50.6 |
| Total | | 102.3 |

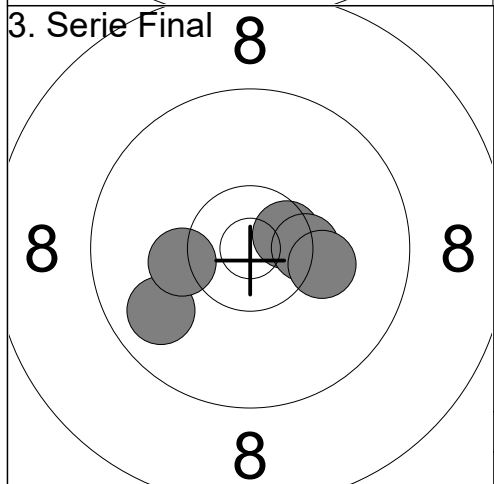

| | | |
|-------|-------|-------|
| 1: | 9.8 | ↖ |
| 2: | 10.6x | → |
| 3: | 10.4x | → |
| 4: | 10.2 | → |
| 5: | 10.2 | ↖ |
| Serie | | 51.2 |
| Total | | 153.5 |

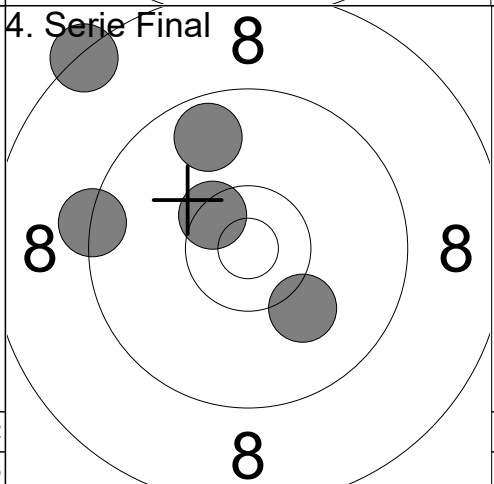

| | | |
|-------|-------|-------|
| 1: | 8.3 | ↗ |
| 2: | 10.1 | ↘ |
| 3: | 9.7 | ↗ |
| 4: | 10.4x | ↗ |
| 5: | 9.3 | ↖ |
| Serie | | 47.8 |
| Total | | 201.3 |

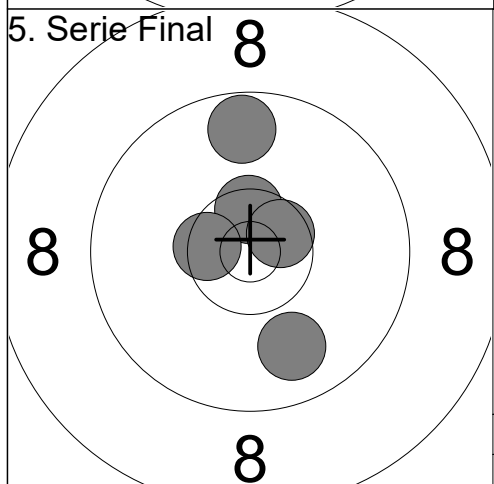

| | | |
|-------|-------|-------|
| 1: | 10.5x | ↑ |
| 2: | 10.6x | → |
| 3: | 10.5x | ↖ |
| 4: | 9.9 | ↘ |
| 5: | 9.7 | ↑ |
| Serie | | 51.2 |
| Total | | 252.5 |

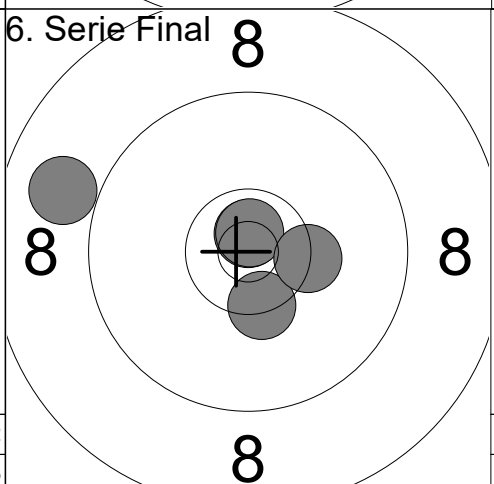

| | | |
|-------|-------|-------|
| 1: | 8.9 | ↖ |
| 2: | 10.8x | ↑ |
| 3: | 10.4x | ↘ |
| 4: | 10.8x | ↑ |
| 5: | 10.3x | → |
| Serie | | 51.2 |
| Total | | 303.7 |



| | | |
|-------|------|-------|
| 1: | 9.2 | ↗ |
| 2: | 9.6 | ↗ |
| 3: | 8.2 | ↖ |
| 4: | 9.7 | ↖ |
| 5: | 10.2 | ↖ |
| Serie | | 46.9 |
| Total | | 350.6 |

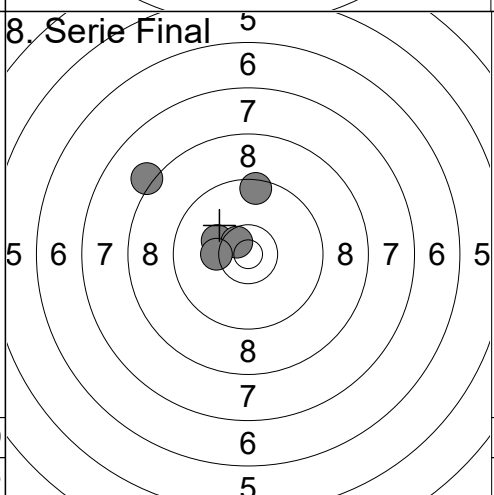

| | | |
|-------|-------|-------|
| 1: | 10.2 | ↖ |
| 2: | 8.2 | ↗ |
| 3: | 9.5 | ↑ |
| 4: | 10.6x | ↗ |
| 5: | 10.3 | ↖ |
| Serie | | 48.8 |
| Total | | 399.4 |

9. Serie Final

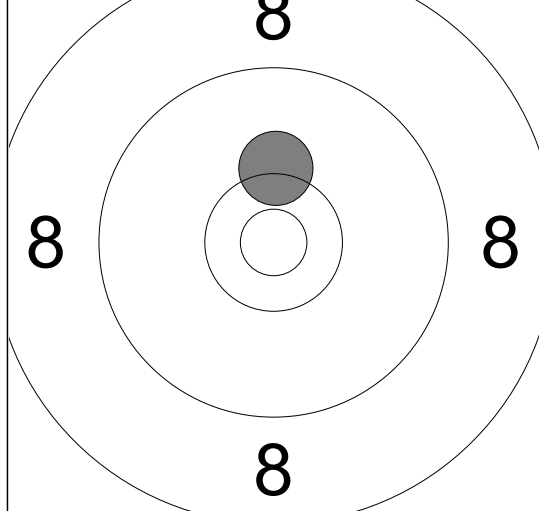

| | |
|-------|-------|
| Serie | 10.3 |
| Total | 409.7 |

1: 10.3 ↑

10. Serie Final

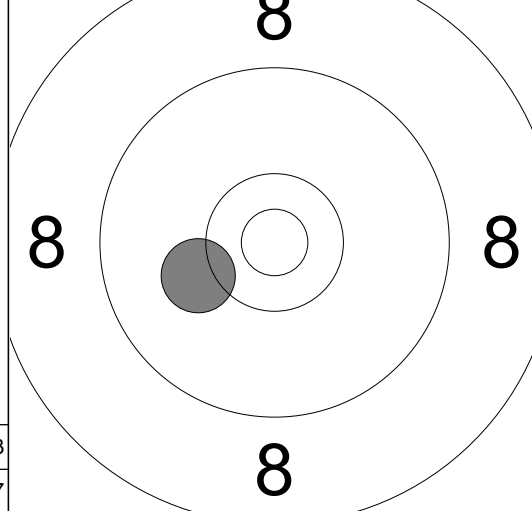

| | |
|-------|-------|
| Serie | 10.2 |
| Total | 419.9 |

1: 10.2 ↙

11. Serie Final

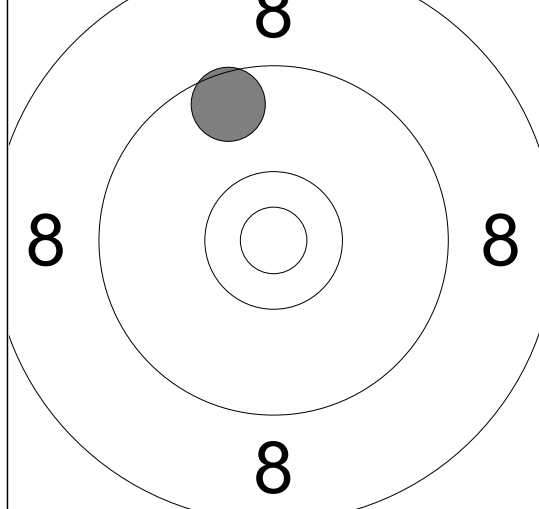

| | |
|-------|-------|
| Serie | 9.6 |
| Total | 429.5 |

1: 9.6 ↖

12. Serie Final

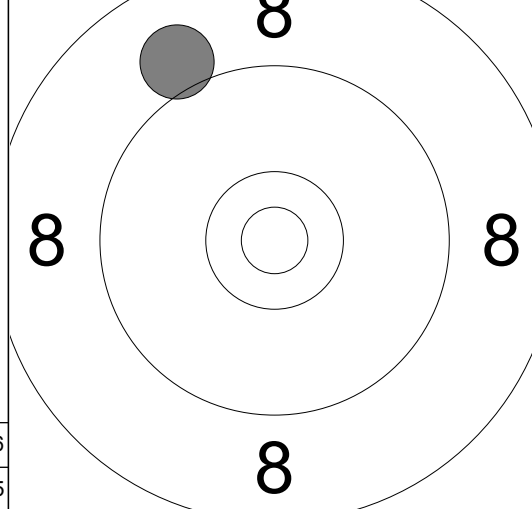

| | |
|-------|-------|
| Serie | 9.0 |
| Total | 438.5 |

1: 9.0 ↗

13. Serie Final

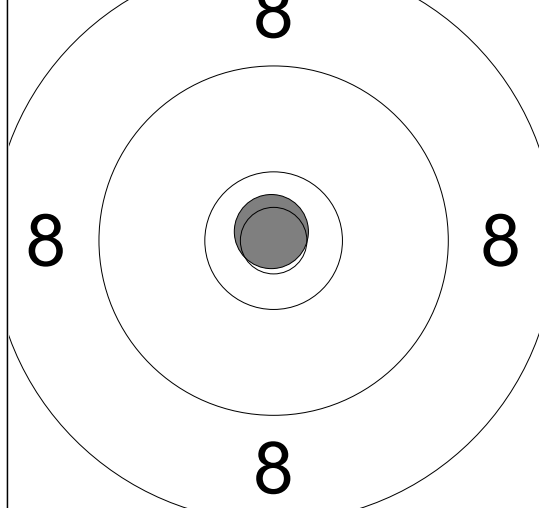

| | |
|-------|-------|
| Serie | 10.9 |
| Total | 449.4 |

1: 10.9x ↑

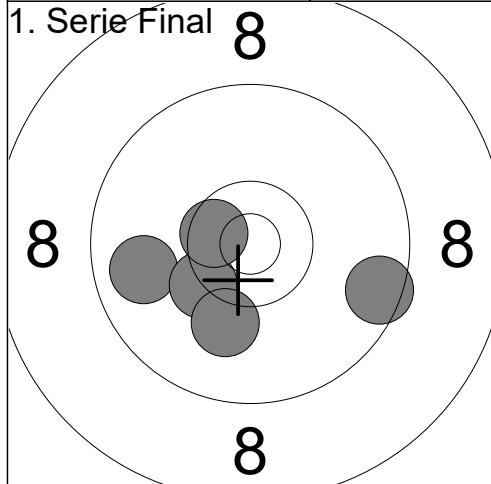

| | | |
|-------|-------|------|
| 1: | 9.8 | ← |
| 2: | 10.3x | ↙ |
| 3: | 9.5 | ↘ |
| 4: | 10.1 | ↘ |
| 5: | 10.6x | ← |
| Serie | | 50.3 |
| Total | | 50.3 |

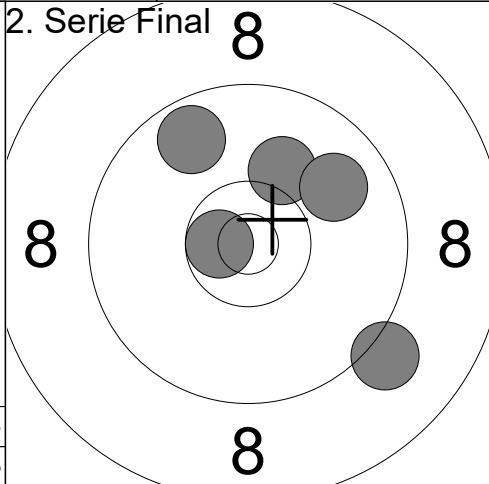

| | | |
|-------|-------|------|
| 1: | 9.7 | ↗ |
| 2: | 10.1 | ↗ |
| 3: | 9.9 | ↗ |
| 4: | 9.1 | ↘ |
| 5: | 10.7x | ← |
| Serie | | 49.5 |
| Total | | 99.8 |

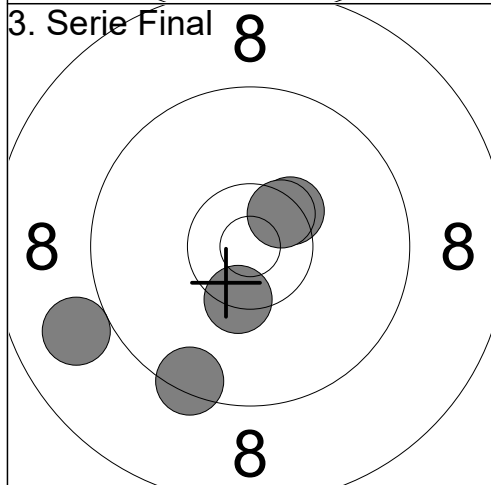

| | | |
|-------|-------|-------|
| 1: | 8.9 | ← |
| 2: | 9.4 | ↘ |
| 3: | 10.4x | ↗ |
| 4: | 10.5x | ↗ |
| 5: | 10.4x | ↘ |
| Serie | | 49.6 |
| Total | | 149.4 |

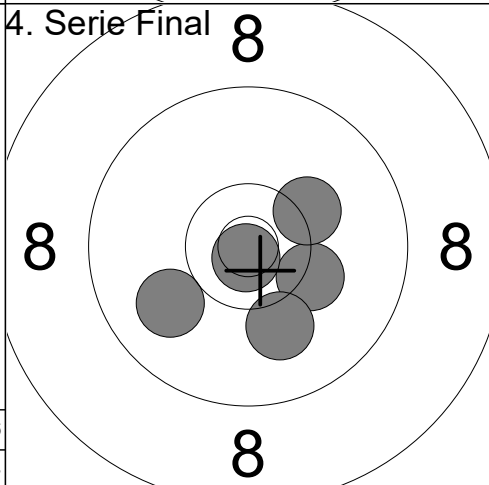

| | | |
|-------|-------|-------|
| 1: | 10.2 | ↘ |
| 2: | 10.1 | ↘ |
| 3: | 10.2 | ↗ |
| 4: | 10.8x | ↘ |
| 5: | 10.0 | ← |
| Serie | | 51.3 |
| Total | | 200.7 |

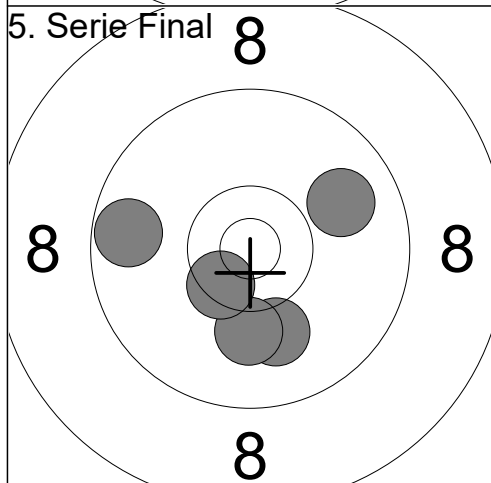

| | | |
|-------|-------|-------|
| 1: | 9.7 | ← |
| 2: | 10.0 | ↘ |
| 3: | 10.1 | ↘ |
| 4: | 9.9 | ↗ |
| 5: | 10.5x | ↘ |
| Serie | | 50.2 |
| Total | | 250.9 |

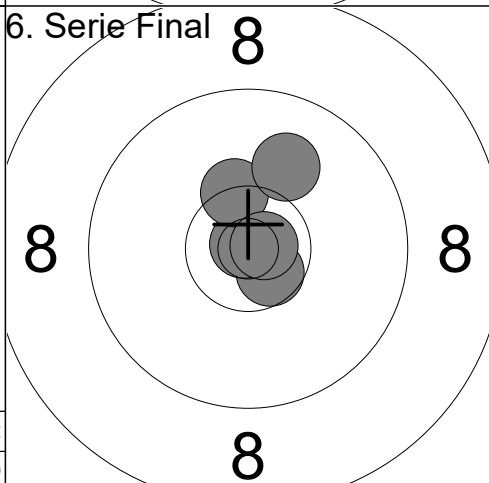

| | | |
|-------|-------|-------|
| 1: | 10.6x | ↘ |
| 2: | 10.9x | ↗ |
| 3: | 10.4x | ↗ |
| 4: | 10.8x | → |
| 5: | 10.0 | ↗ |
| Serie | | 52.7 |
| Total | | 303.6 |

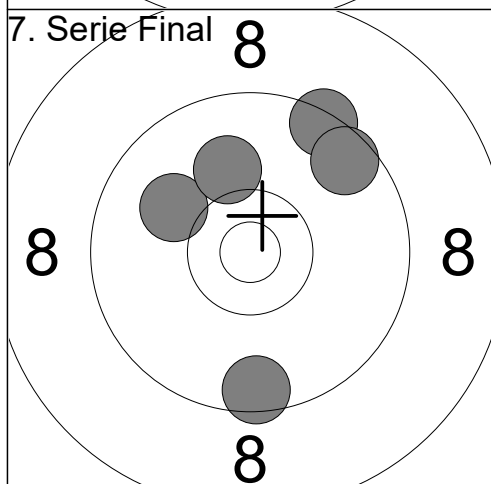

| | | |
|-------|------|-------|
| 1: | 9.4 | ↗ |
| 2: | 10.0 | ← |
| 3: | 9.6 | ↗ |
| 4: | 10.1 | ↗ |
| 5: | 9.5 | ↘ |
| Serie | | 48.6 |
| Total | | 352.2 |

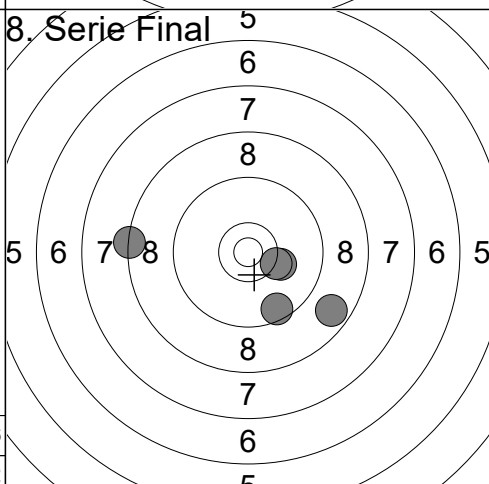

| | | |
|-------|-------|-------|
| 1: | 10.2 | → |
| 2: | 8.3 | ← |
| 3: | 9.5 | ↘ |
| 4: | 8.7 | ↘ |
| 5: | 10.3x | → |
| Serie | | 47.0 |
| Total | | 399.2 |

9. Serie Final

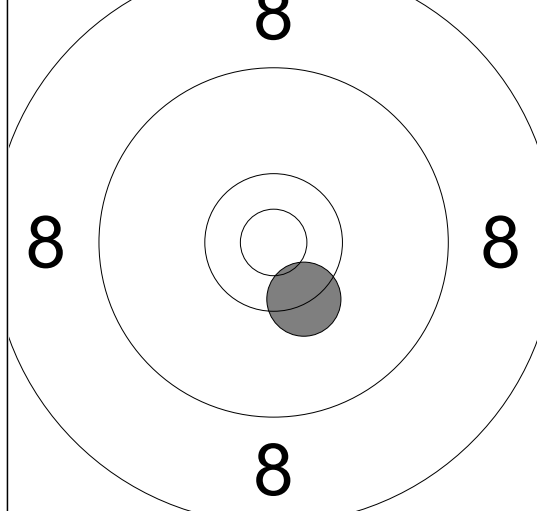

| | |
|-------|-------|
| Serie | 10.3 |
| Total | 409.5 |

10. Serie Final

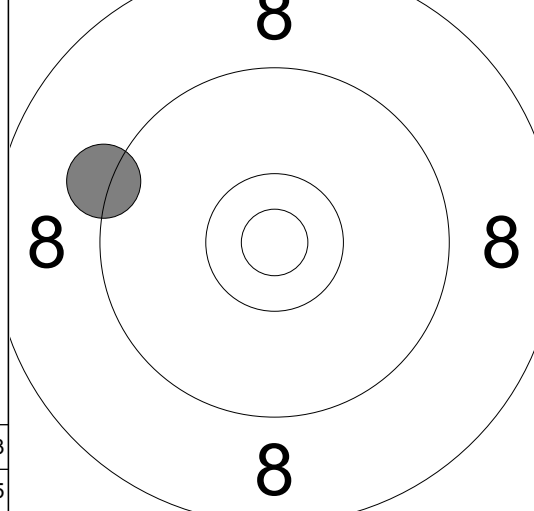

| | |
|-------|-------|
| Serie | 9.2 |
| Total | 418.7 |

11. Serie Final

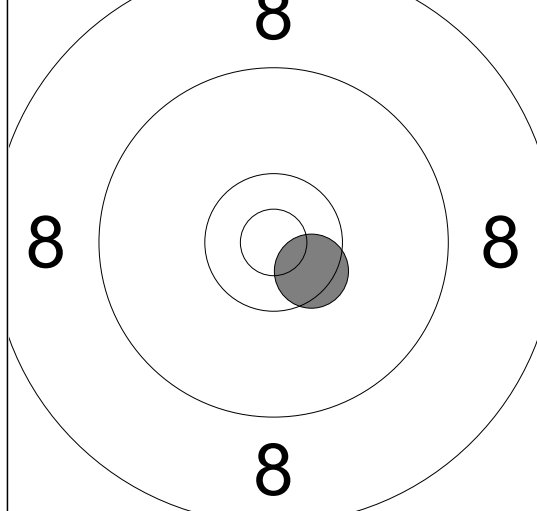

| | |
|-------|-------|
| Serie | 10.5 |
| Total | 429.2 |

12. Serie Final

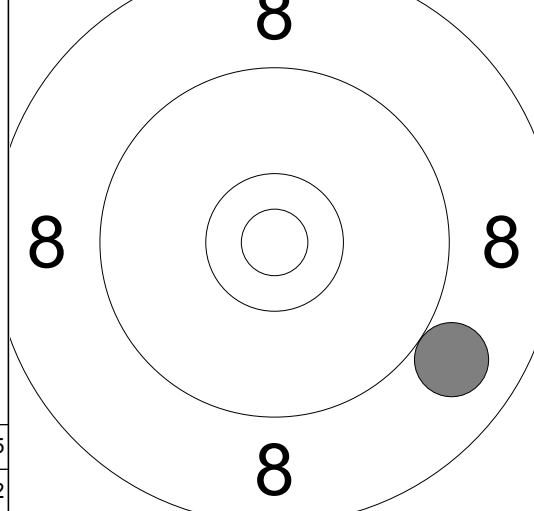

| | |
|-------|-------|
| Serie | 8.9 |
| Total | 438.1 |

13. Serie Final

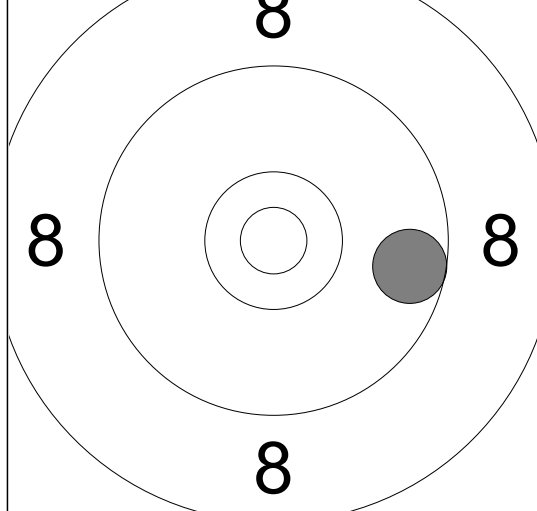

| | |
|-------|-------|
| Serie | 9.6 |
| Total | 447.7 |

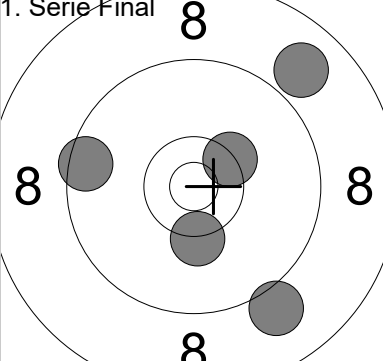
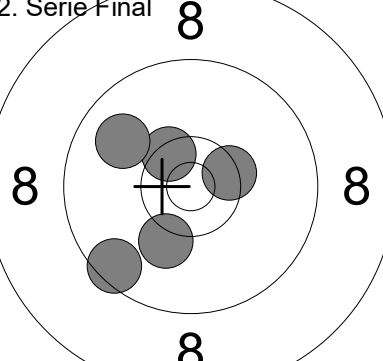
| | | | |
|---|---|---|---|
| 1. Serie Final  | 1: 10.3 ↓ 2: 8.9 ↗ 3: 9.5 ↖ 4: 9.0 ↓ 5: 10.4x ↗ | 2. Serie Final  | 1: 10.4x ↗ 2: 9.9 ↗ 3: 10.4x → 4: 10.2 ↓ 5: 9.5 ↖ |
| Serie 48.1 | | Serie 50.4 | |
| Total 48.1 | | Total 98.5 | |

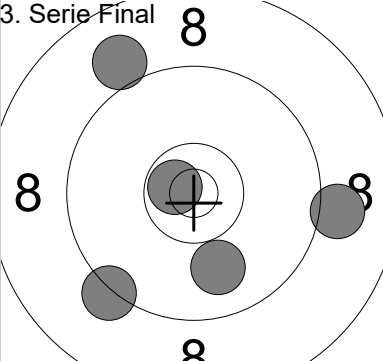
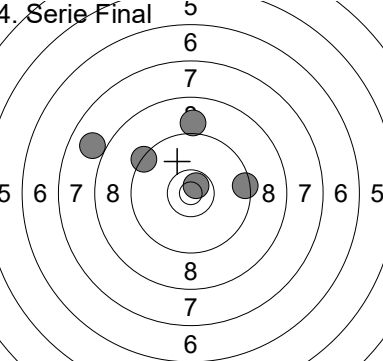
| | | | |
|---|--|---|--|
| 3. Serie Final  | 1: 9.0 ↗ 2: 9.1 → 3: 9.9 ↓ 4: 10.7x ↖ 5: 9.3 ↓ | 4. Serie Final  | 1: 7.9 ↖ 2: 10.7x ↗ 3: 9.4 → 4: 9.0 ↑ 5: 9.4 ↗ |
| Serie 48.0 | | Serie 46.4 | |
| Total 146.5 | | Total 192.9 | |

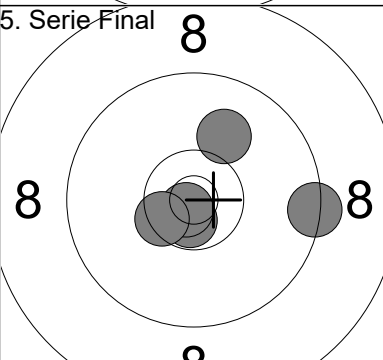
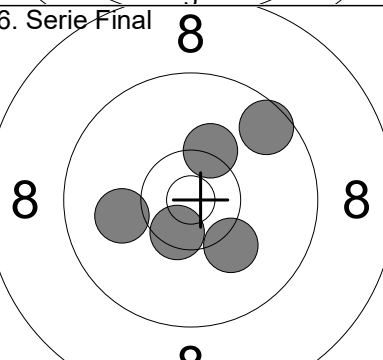
| | | | |
|--|---|--|---|
| 5. Serie Final  | 1: 10.0 ↗ 2: 10.7x ↓ 3: 10.8x ↓ 4: 9.4 → 5: 10.5x ↖ | 6. Serie Final  | 1: 10.5x ↓ 2: 10.3 ↗ 3: 10.2 ↓ 4: 9.6 ↗ 5: 10.0 ↖ |
| Serie 51.4 | | Serie 50.6 | |
| Total 244.3 | | Total 294.9 | |

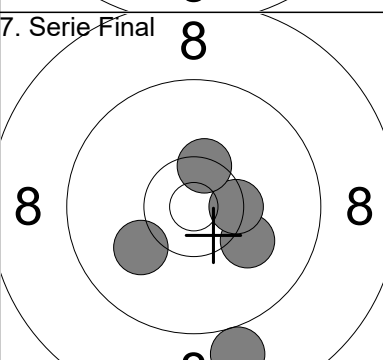
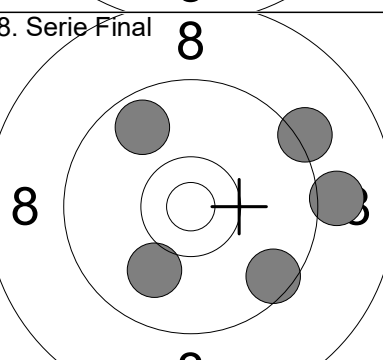
| | | | |
|---|--|---|---|
| 7. Serie Final  | 1: 10.1 ↖ 2: 9.0 ↓ 3: 10.1 ↓ 4: 10.4x → 5: 10.4x ↑ | 8. Serie Final  | 1: 9.7 ↗ 2: 9.2 ↗ 3: 9.0 → 4: 9.6 ↓ 5: 10.0 ↓ |
| Serie 50.0 | | Serie 47.5 | |
| Total 344.9 | | Total 392.4 | |

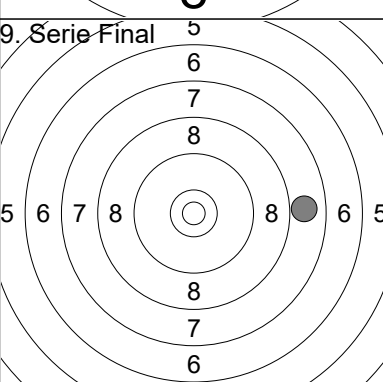
| | | | |
|---|----------|--|--|
| 9. Serie Final  | 1: 7.9 → | | |
| Serie 7.9 | | | |
| Total 400.3 | | | |

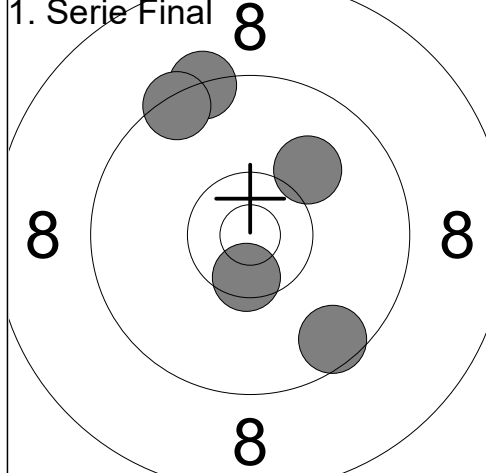

| | | |
|-------|-------|------|
| 1: | 9.3 | ↗ |
| 2: | 9.4 | ↗ |
| 3: | 9.6 | ↘ |
| 4: | 10.5x | ↘ |
| 5: | 10.0 | ↗ |
| Serie | | 48.8 |
| Total | | 48.8 |

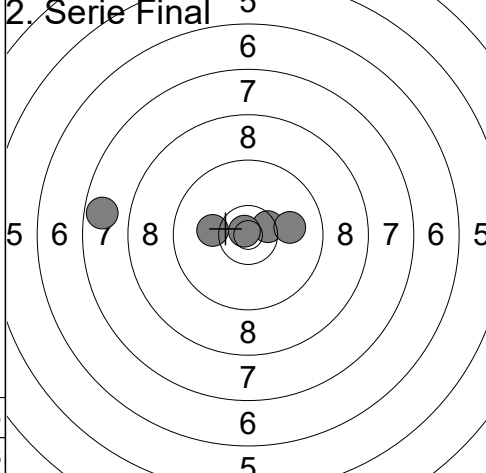

| | | |
|-------|-------|------|
| 1: | 7.7 | ← |
| 2: | 10.5x | → |
| 3: | 10.8x | ↗ |
| 4: | 10.0 | → |
| 5: | 10.2 | ← |
| Serie | | 49.2 |
| Total | | 98.0 |

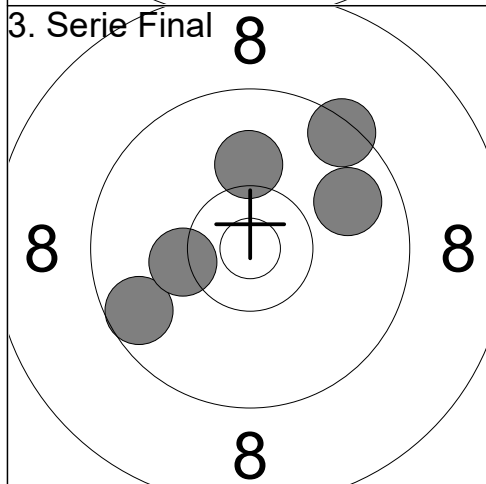

| | | |
|-------|------|-------|
| 1: | 9.6 | ← |
| 2: | 9.8 | → |
| 3: | 10.2 | ← |
| 4: | 10.1 | ↑ |
| 5: | 9.4 | ↗ |
| Serie | | 49.1 |
| Total | | 147.1 |

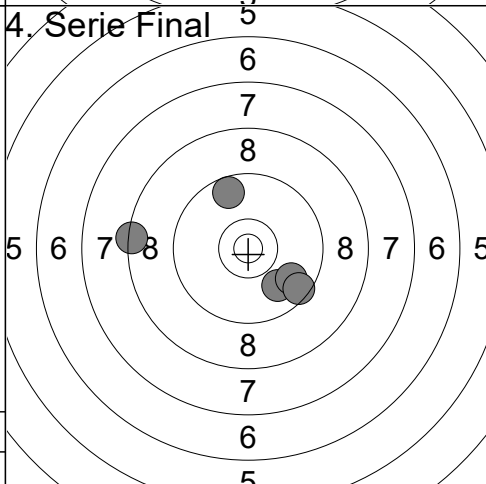

| | | |
|-------|-----|-------|
| 1: | 8.4 | ← |
| 2: | 9.9 | ↘ |
| 3: | 9.8 | ↘ |
| 4: | 9.5 | ↘ |
| 5: | 9.6 | ↗ |
| Serie | | 47.2 |
| Total | | 194.3 |

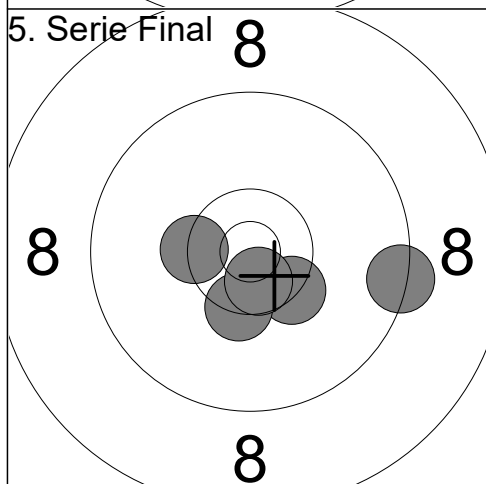

| | | |
|-------|-------|-------|
| 1: | 10.4x | ↘ |
| 2: | 10.4x | ← |
| 3: | 10.4x | ↘ |
| 4: | 10.6x | ↘ |
| 5: | 9.4 | → |
| Serie | | 51.2 |
| Total | | 245.5 |

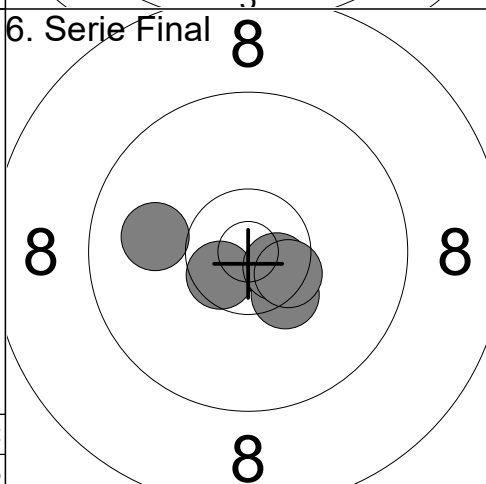

| | | |
|-------|-------|-------|
| 1: | 10.4x | ↘ |
| 2: | 10.0 | ← |
| 3: | 10.6x | ↘ |
| 4: | 10.6x | ↘ |
| 5: | 10.5x | ↘ |
| Serie | | 52.1 |
| Total | | 297.6 |

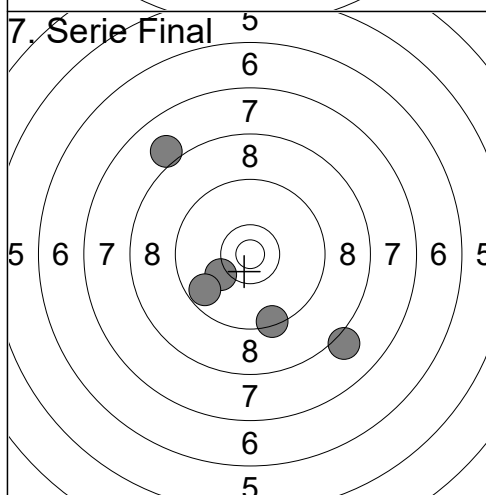

| | | |
|-------|------|-------|
| 1: | 9.4 | ↘ |
| 2: | 8.0 | ↗ |
| 3: | 10.2 | ↘ |
| 4: | 9.7 | ↘ |
| 5: | 8.1 | ↘ |
| Serie | | 45.4 |
| Total | | 343.0 |

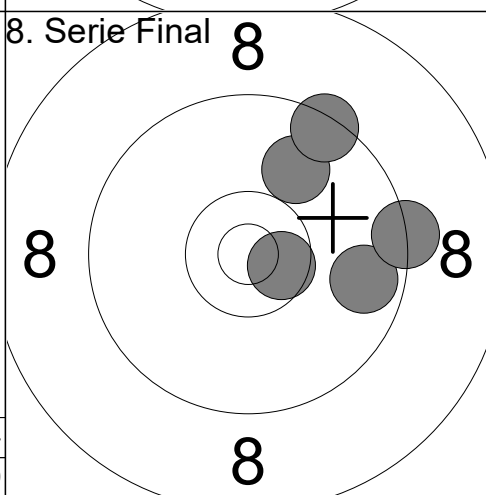

| | | |
|-------|-------|-------|
| 1: | 9.9 | ↗ |
| 2: | 9.4 | ↗ |
| 3: | 9.7 | → |
| 4: | 10.6x | → |
| 5: | 9.3 | → |
| Serie | | 48.9 |
| Total | | 391.9 |

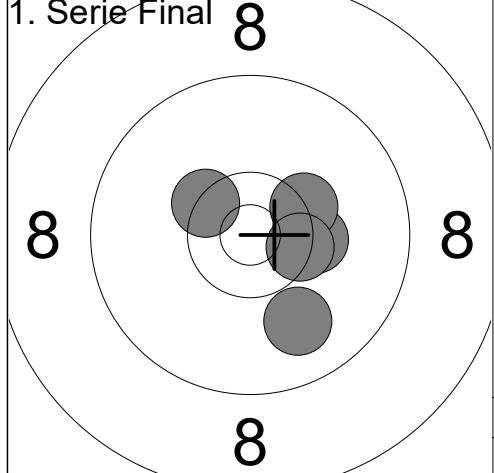

| | | |
|-------|-------|------|
| 1: | 10.3 | → |
| 2: | 10.4x | ↗ |
| 3: | 10.3x | ↗ |
| 4: | 10.4x | → |
| 5: | 9.9 | ↘ |
| Serie | | 51.3 |
| Total | | 51.3 |

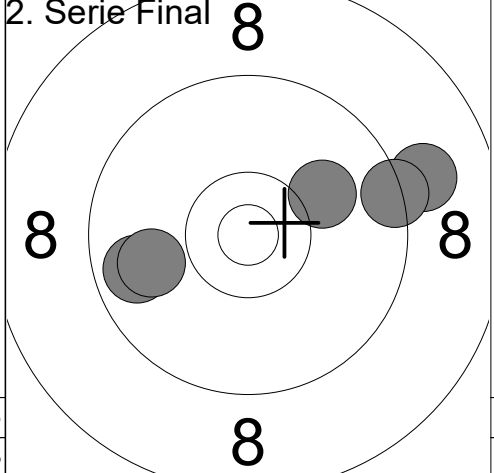

| | | |
|-------|------|------|
| 1: | 9.7 | ← |
| 2: | 9.9 | ← |
| 3: | 9.0 | → |
| 4: | 9.4 | → |
| 5: | 10.1 | ↗ |
| Serie | | 48.1 |
| Total | | 99.4 |

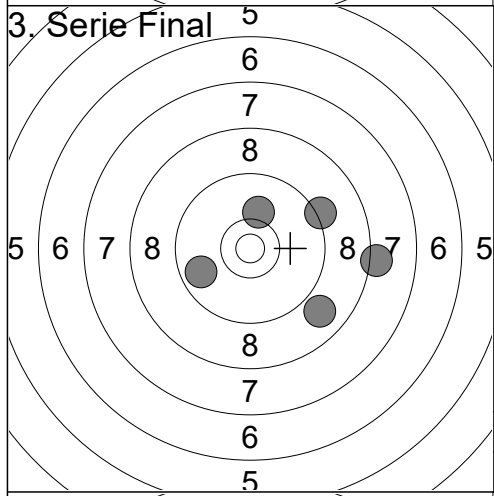

| | | |
|-------|------|-------|
| 1: | 9.7 | ← |
| 2: | 8.2 | → |
| 3: | 9.2 | ↗ |
| 4: | 8.9 | ↘ |
| 5: | 10.1 | ↑ |
| Serie | | 46.1 |
| Total | | 145.5 |

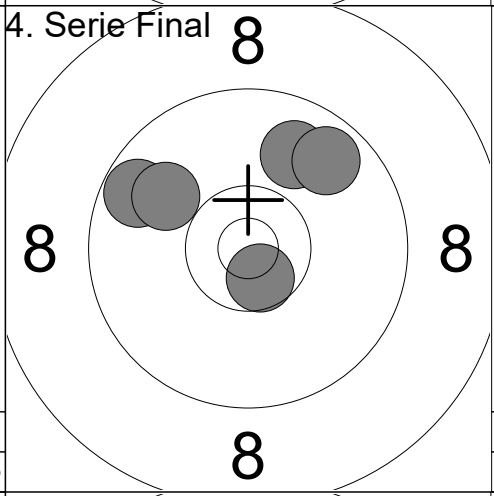

| | | |
|-------|-------|-------|
| 1: | 9.7 | ↖ |
| 2: | 9.9 | ↗ |
| 3: | 9.7 | ↗ |
| 4: | 9.9 | ↖ |
| 5: | 10.6x | ↘ |
| Serie | | 49.8 |
| Total | | 195.3 |

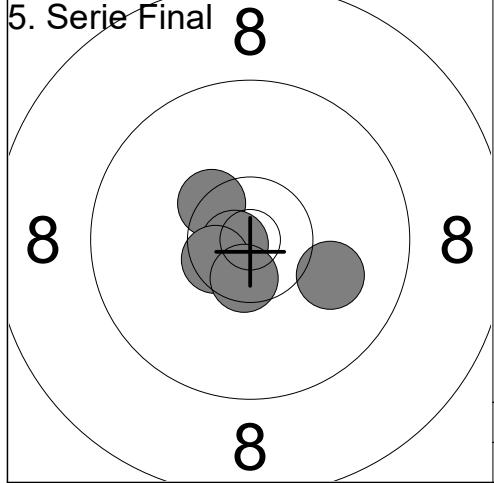

| | | |
|-------|-------|-------|
| 1: | 10.4x | ↖ |
| 2: | 10.8x | ← |
| 3: | 10.5x | ← |
| 4: | 10.0 | → |
| 5: | 10.5x | ↘ |
| Serie | | 52.2 |
| Total | | 247.5 |

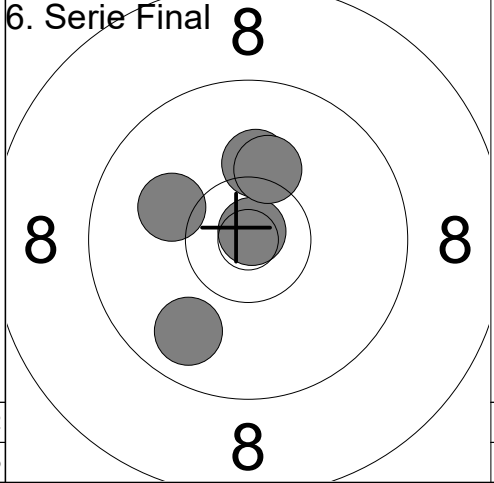

| | | |
|-------|-------|-------|
| 1: | 10.9x | ↗ |
| 2: | 10.1 | ↖ |
| 3: | 10.2 | ↑ |
| 4: | 10.2 | ↑ |
| 5: | 9.8 | ↘ |
| Serie | | 51.2 |
| Total | | 298.7 |

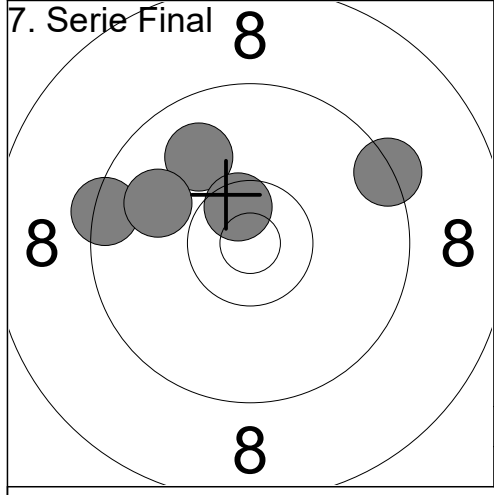

| | | |
|-------|-------|-------|
| 1: | 9.9 | ↗ |
| 2: | 9.4 | ← |
| 3: | 9.9 | ↖ |
| 4: | 10.6x | ↗ |
| 5: | 9.3 | ↗ |
| Serie | | 49.1 |
| Total | | 347.8 |

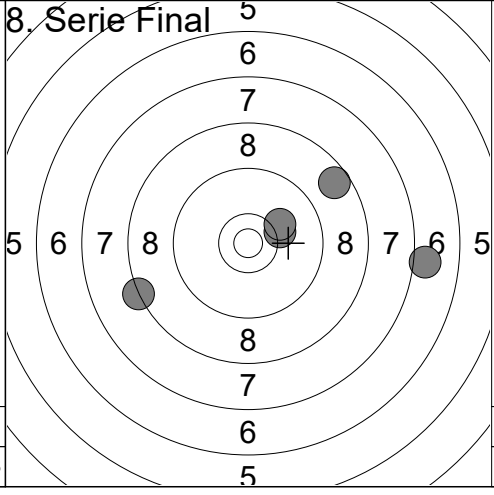

| | | |
|-------|------|-------|
| 1: | 10.2 | → |
| 2: | 8.3 | ← |
| 3: | 8.6 | ↗ |
| 4: | 10.1 | ↗ |
| 5: | 7.0 | → |
| Serie | | 44.2 |
| Total | | 392.0 |

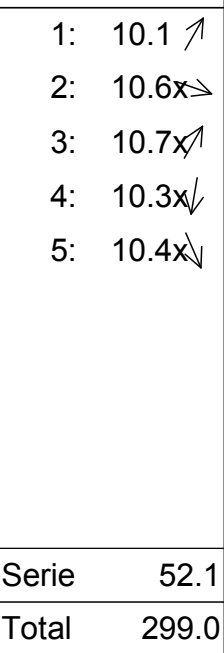
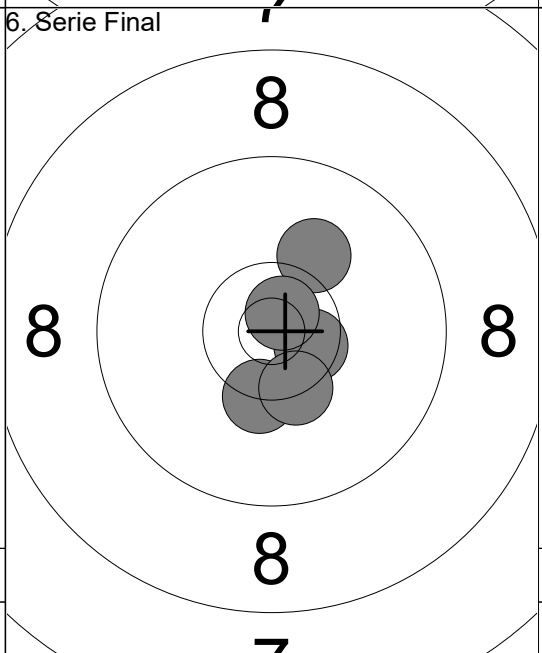
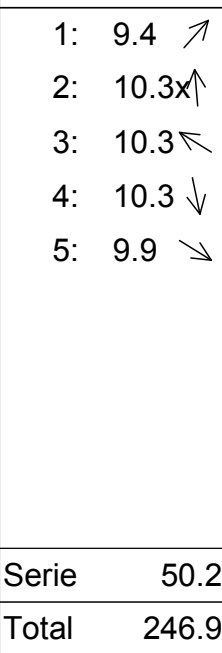
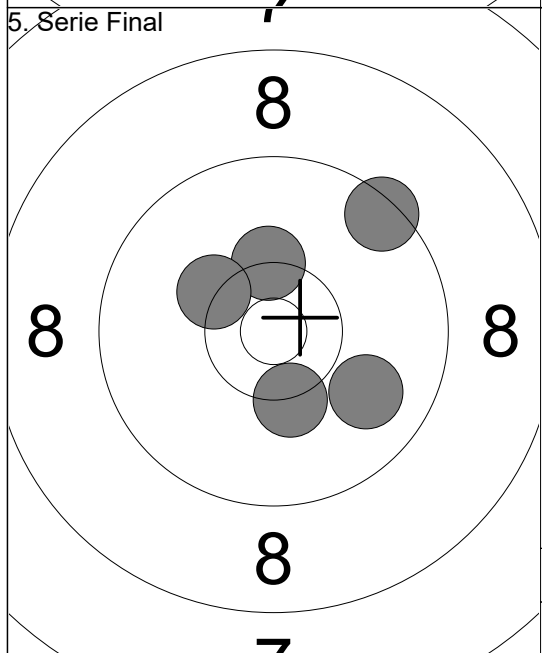
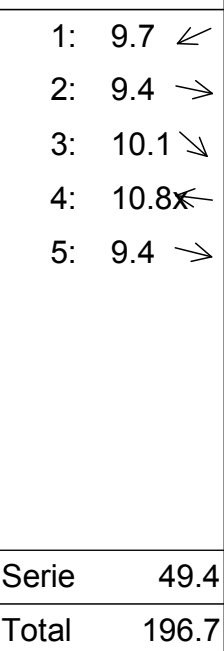
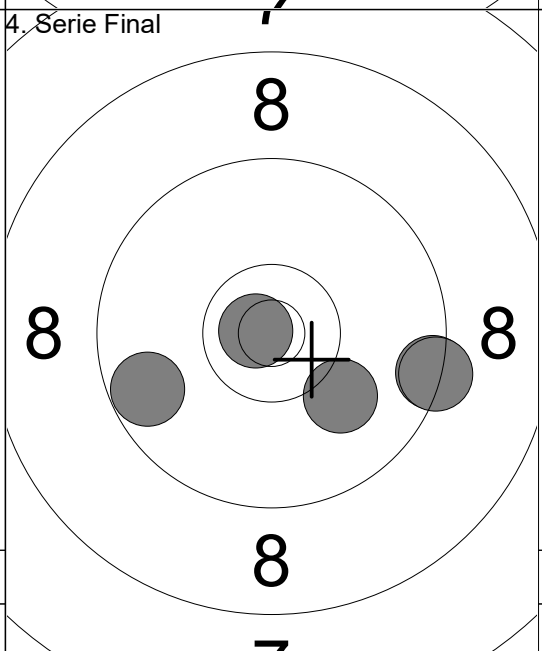
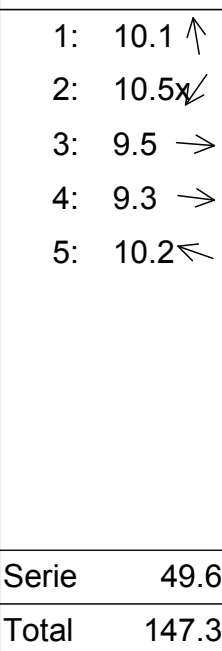
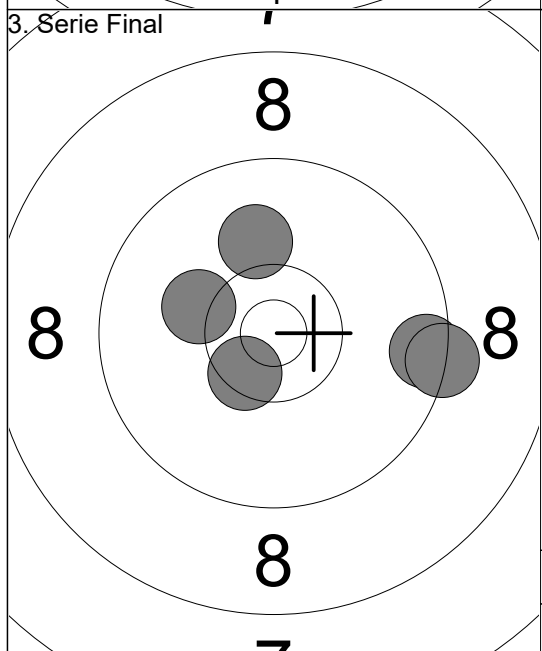
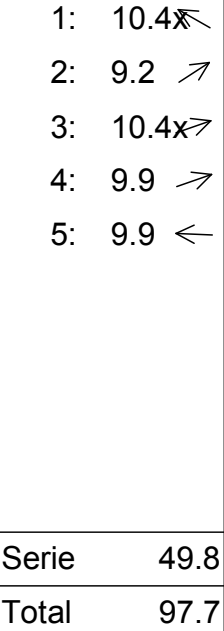
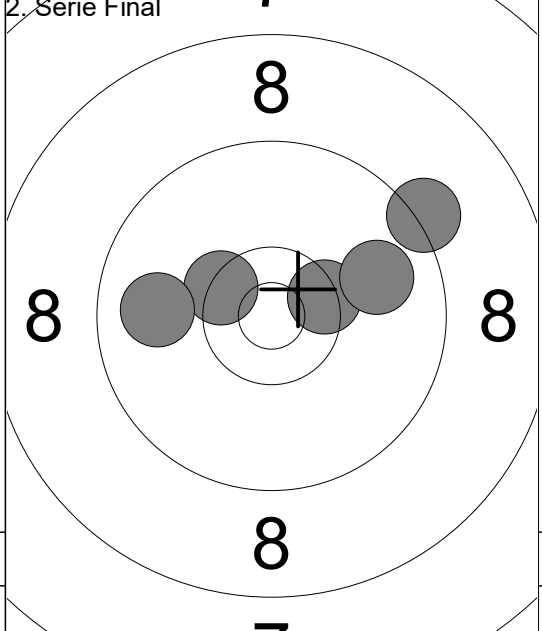
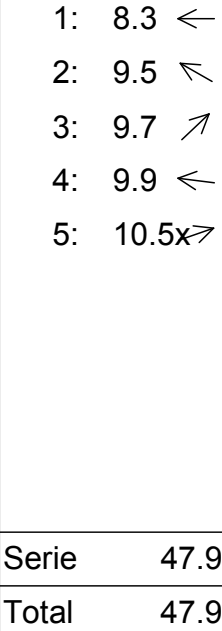
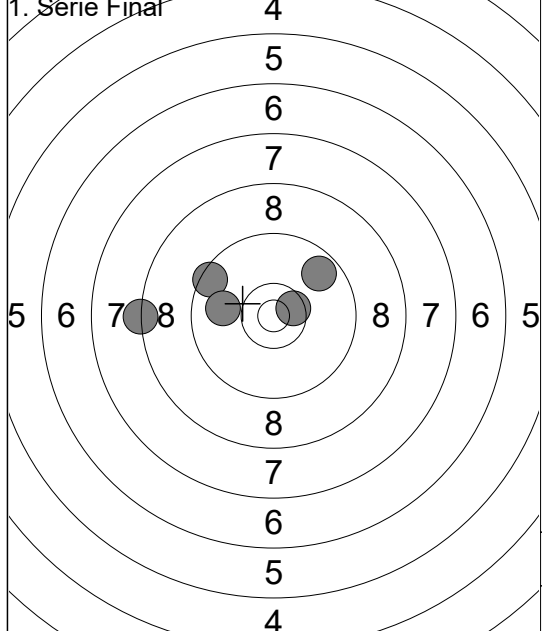

7. Serie Final

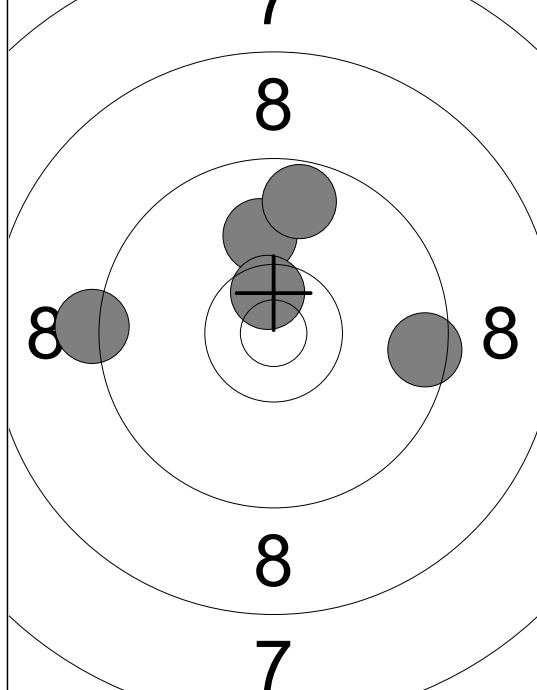

1: 10.0 ↑
 2: 9.5 →
 3: 9.2 ←
 4: 9.7 ↑
 5: 10.6x ↑

| | |
|-------|-------|
| Serie | 49.0 |
| Total | 348.0 |

8. Serie Final

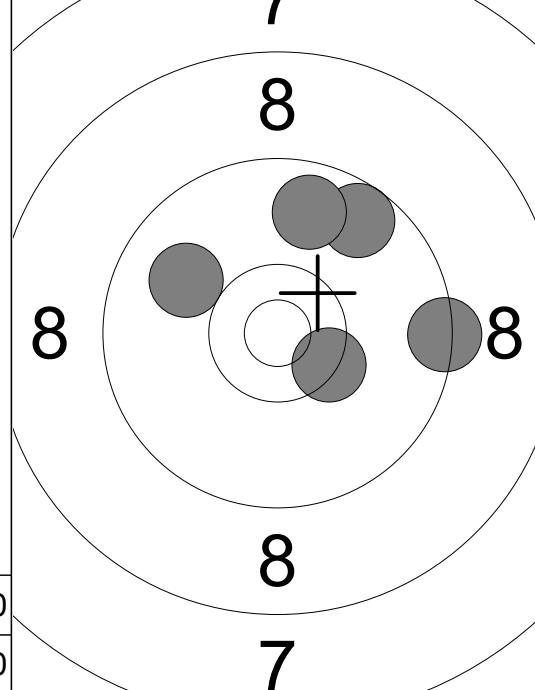

1: 9.6 ↗
 2: 10.0 ↖
 3: 9.8 ↑
 4: 9.4 →
 5: 10.4x ↘

| | |
|-------|-------|
| Serie | 49.2 |
| Total | 397.2 |

9. Serie Final

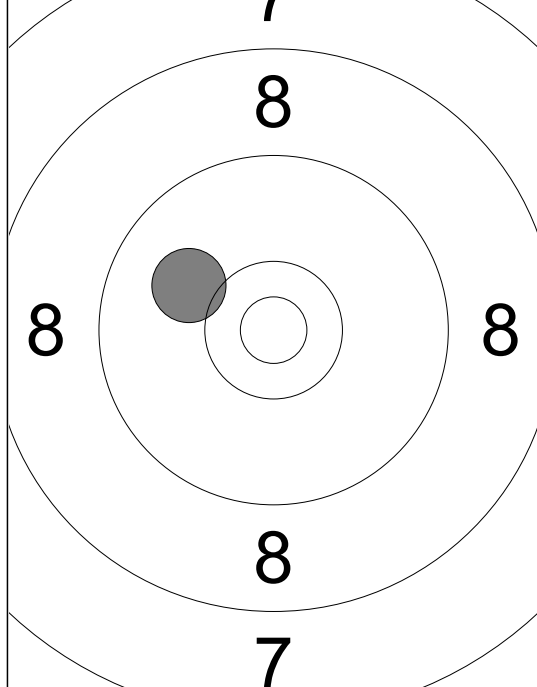

1: 10.0 ↖

| | |
|-------|-------|
| Serie | 10.0 |
| Total | 407.2 |

10. Serie Final

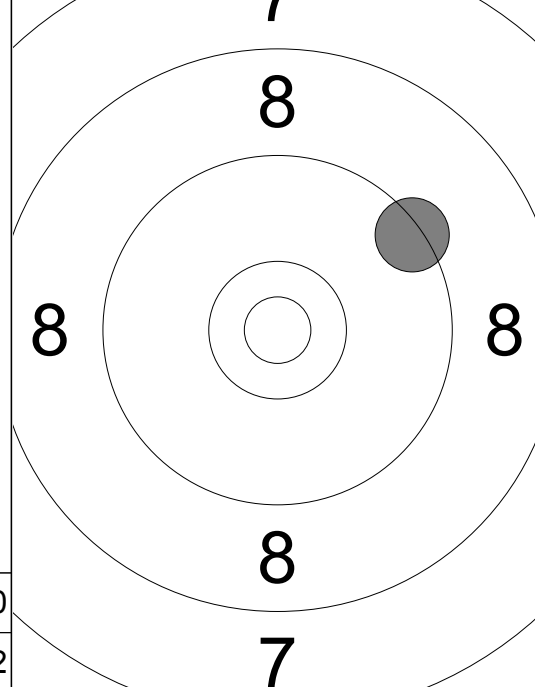

1: 9.4 ↗

| | |
|-------|-------|
| Serie | 9.4 |
| Total | 416.6 |

11. Serie Final

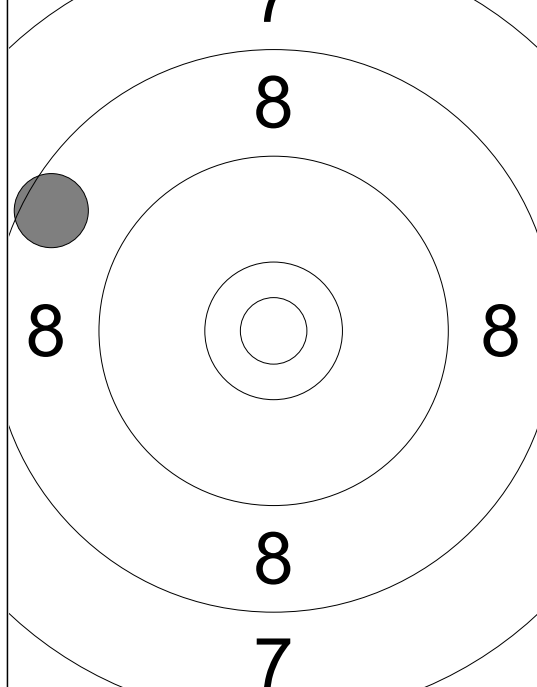

1: 8.6 ↖

| | |
|-------|-------|
| Serie | 8.6 |
| Total | 425.2 |

12. Serie Final

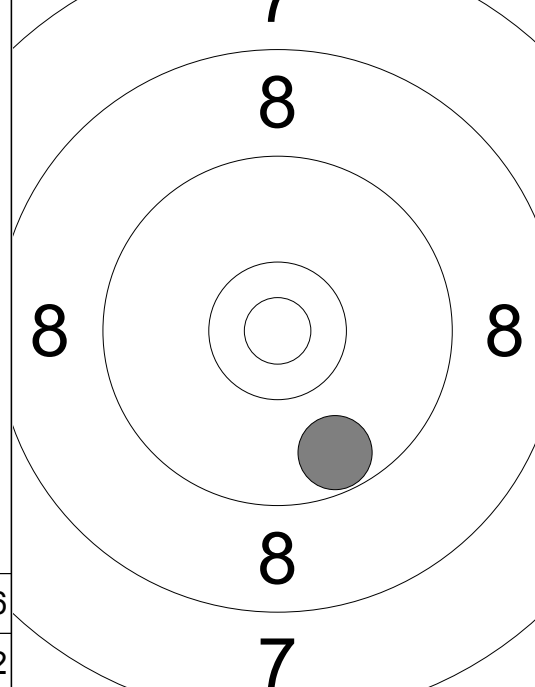

1: 9.7 ↓

| | |
|-------|-------|
| Serie | 9.7 |
| Total | 434.9 |

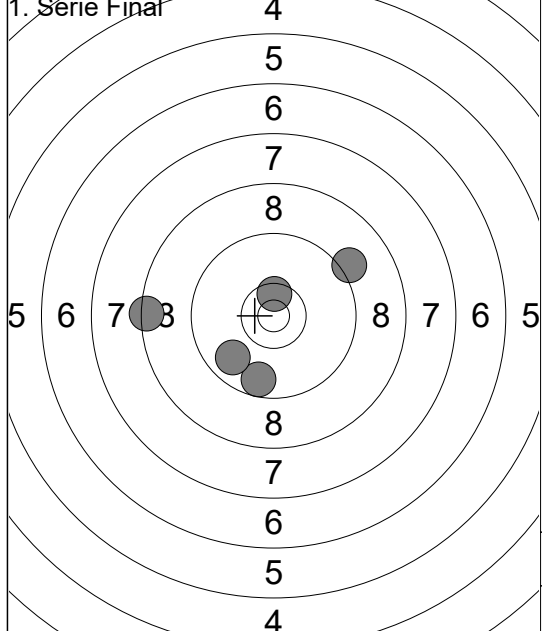

| |
|------------|
| 1: 10.5x ↗ |
| 2: 8.4 ← |
| 3: 9.6 ↓ |
| 4: 9.8 ↙ |
| 5: 9.1 ↘ |
| Serie 47.4 |
| Total 47.4 |

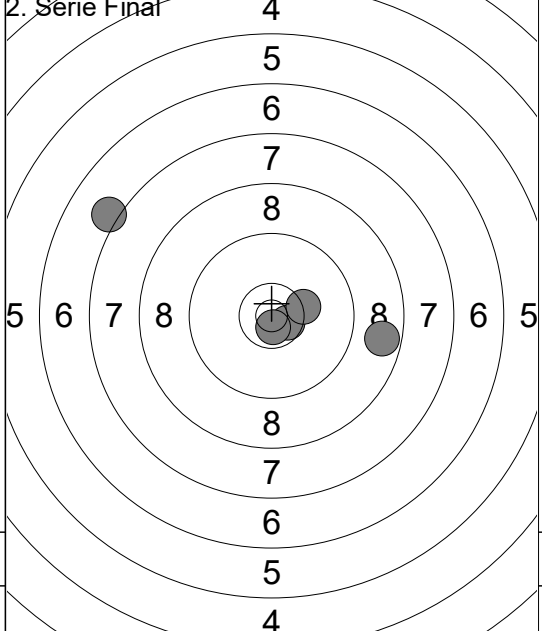

| |
|------------|
| 1: 7.1 ↖ |
| 2: 10.6x ➤ |
| 3: 10.7x ↘ |
| 4: 10.3 ➔ |
| 5: 8.7 ➔ |
| Serie 47.4 |
| Total 94.8 |

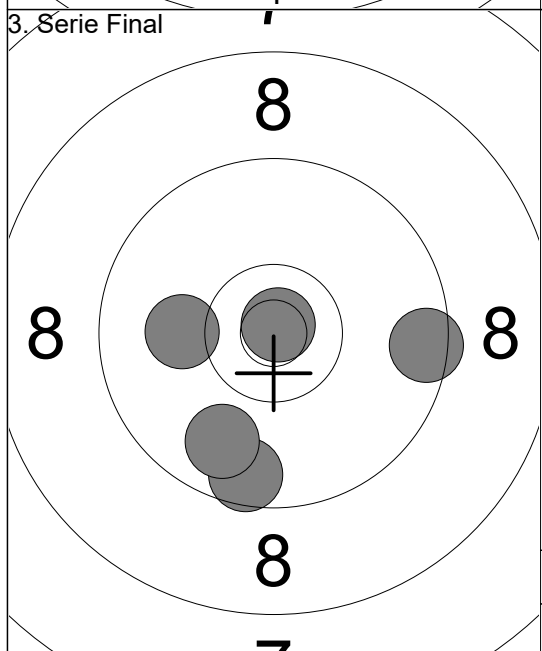

| |
|-------------|
| 1: 10.9x ↗ |
| 2: 9.6 ↓ |
| 3: 9.5 ➔ |
| 4: 10.1 ← |
| 5: 9.8 ↙ |
| Serie 49.9 |
| Total 144.7 |

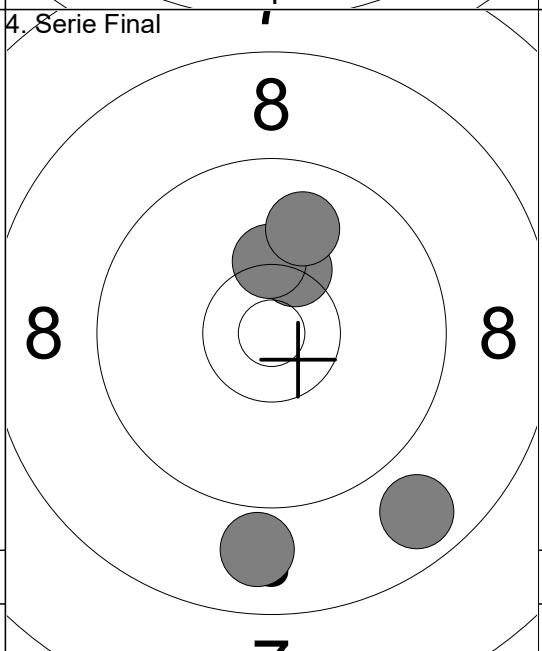

| |
|-------------|
| 1: 10.3x ↗ |
| 2: 10.3 ↑ |
| 3: 9.9 ↑ |
| 4: 8.8 ↘ |
| 5: 8.9 ↓ |
| Serie 48.2 |
| Total 192.9 |

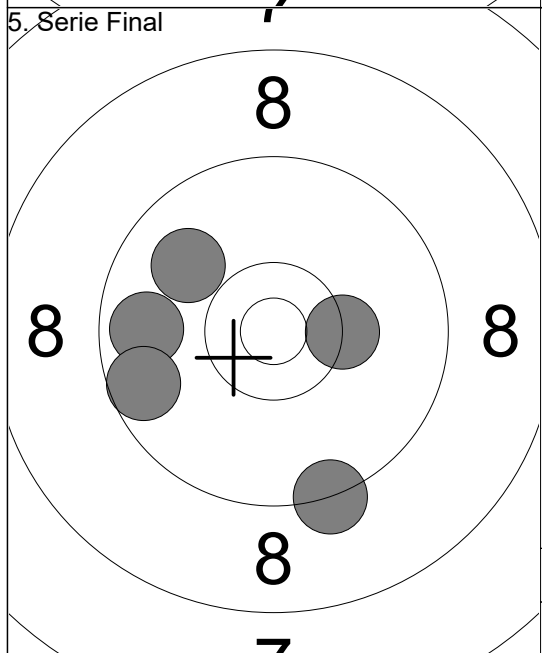

| |
|-------------|
| 1: 10.3x ➤ |
| 2: 9.8 ← |
| 3: 9.9 ↖ |
| 4: 9.3 ↓ |
| 5: 9.6 ↙ |
| Serie 48.9 |
| Total 241.8 |

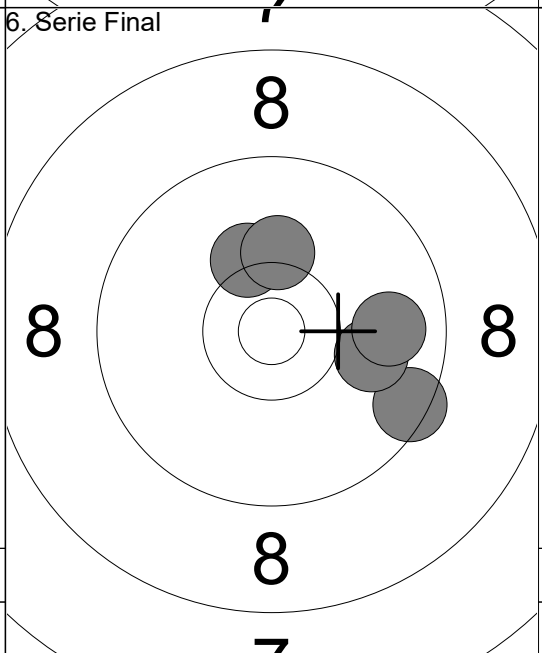

| |
|-------------|
| 1: 9.5 ➤ |
| 2: 10.0 ➔ |
| 3: 10.2 ↗ |
| 4: 9.8 ➔ |
| 5: 10.2 ↑ |
| Serie 49.7 |
| Total 291.5 |

7. Serie Final

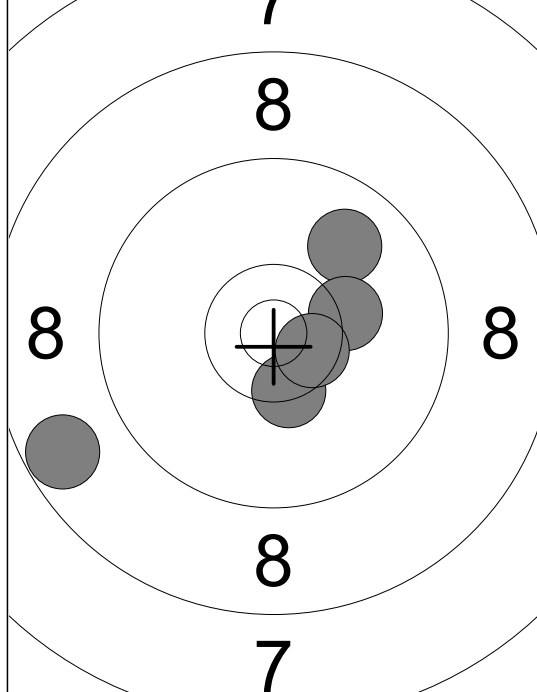

- 1: 8.7 ↙
- 2: 9.9 ↗
- 3: 10.2 →
- 4: 10.4x ↘
- 5: 10.6x ↘

| | |
|-------|-------|
| Serie | 49.8 |
| Total | 341.3 |

8. Serie Final

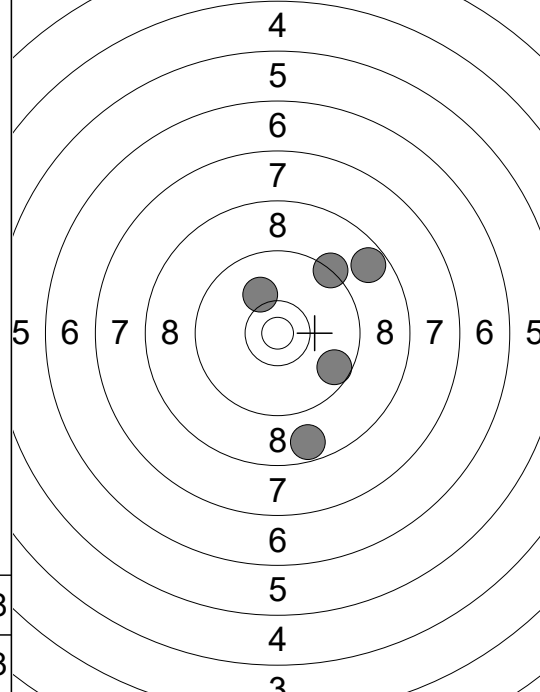

- 1: 8.7 ↗
- 2: 10.1 ↖
- 3: 9.6 ↘
- 4: 8.7 ↘
- 5: 9.3 ↗

| | |
|-------|-------|
| Serie | 46.4 |
| Total | 387.7 |

9. Serie Final

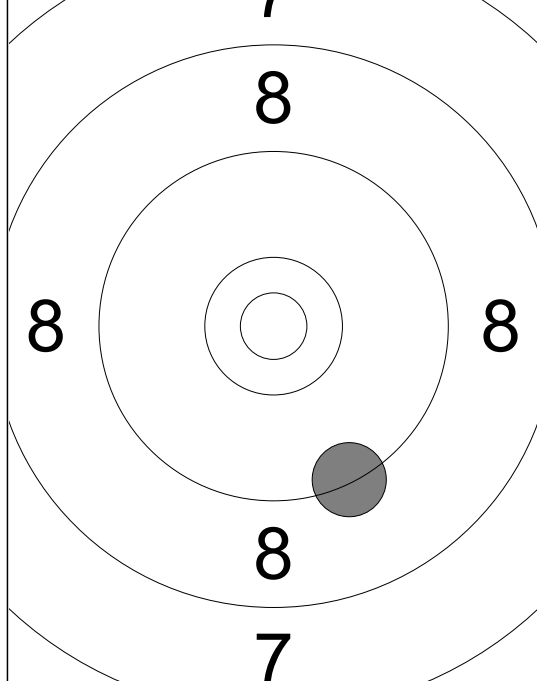

- 1: 9.3 ↘

| | |
|-------|-------|
| Serie | 9.3 |
| Total | 397.0 |

10. Serie Final

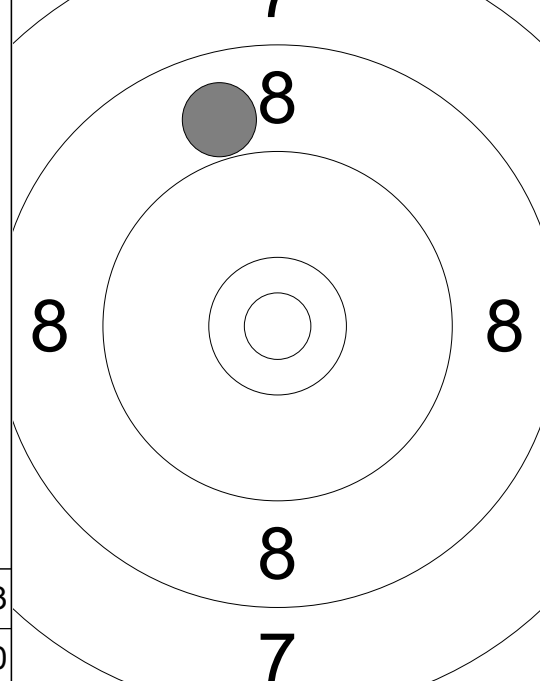

- 1: 8.9 ↖

| | |
|-------|-------|
| Serie | 8.9 |
| Total | 405.9 |

11. Serie Final

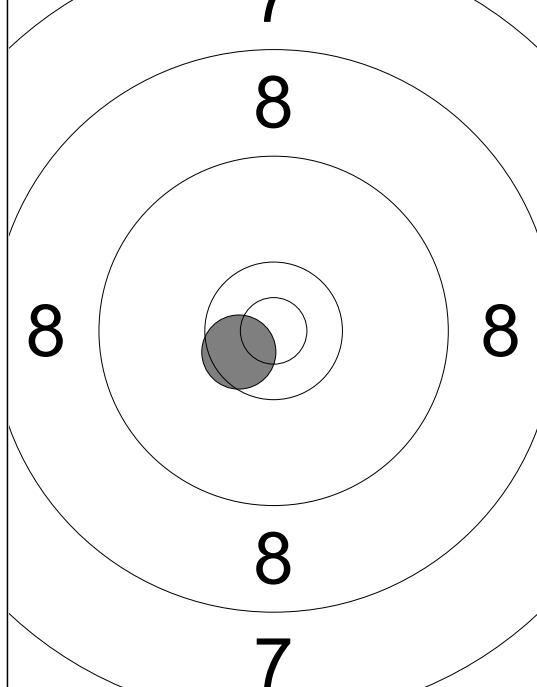

- 1: 10.6x ↘

| | |
|-------|-------|
| Serie | 10.6 |
| Total | 416.5 |

12. Serie Final

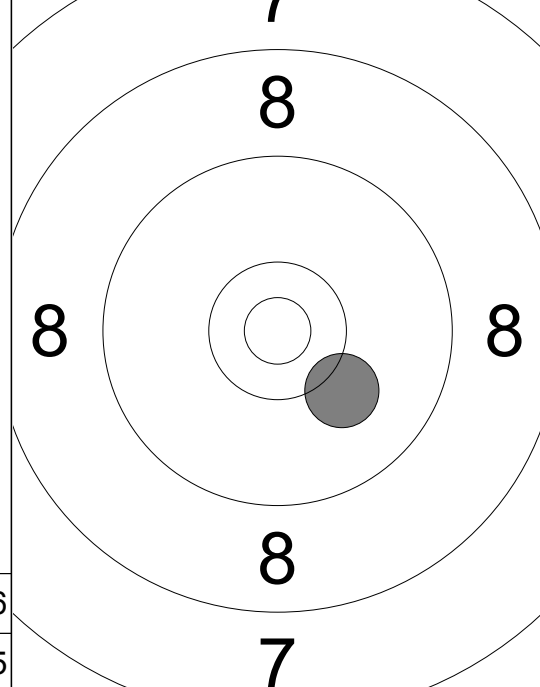

- 1: 10.1 ↘

| | |
|-------|-------|
| Serie | 10.1 |
| Total | 426.6 |

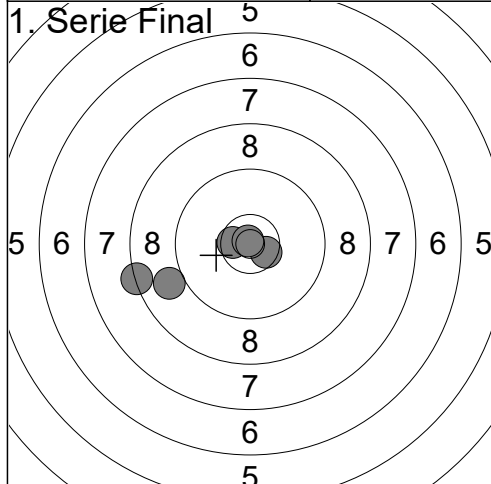

| | | |
|-------|-------|------|
| 1: | 10.6x | ← |
| 2: | 8.3 | ← |
| 3: | 9.0 | ← |
| 4: | 10.6x | → |
| 5: | 10.9x | ↗ |
| Serie | | 49.4 |
| Total | | 49.4 |

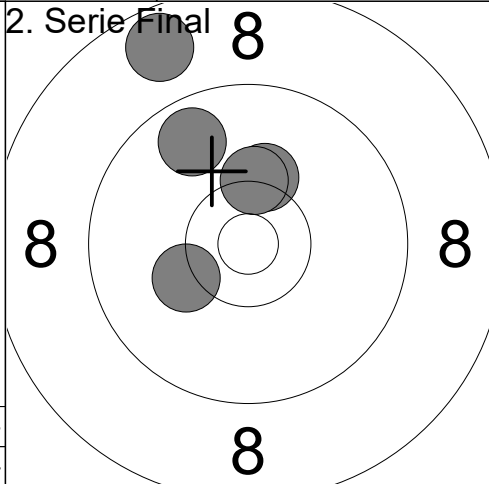

| | | |
|-------|------|------|
| 1: | 10.2 | ← |
| 2: | 8.7 | ↖ |
| 3: | 10.2 | ↗ |
| 4: | 9.7 | ↖ |
| 5: | 10.3 | ↗ |
| Serie | | 49.1 |
| Total | | 98.5 |

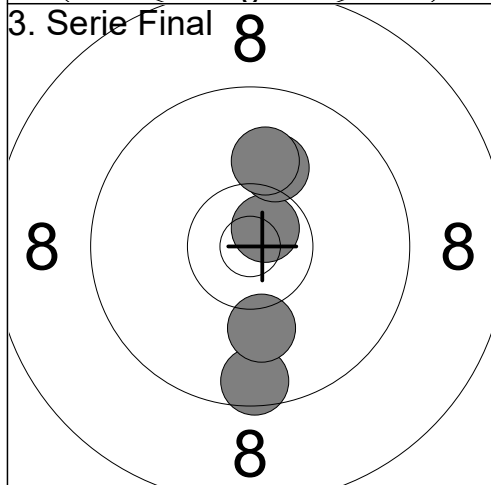

| | | |
|-------|-------|-------|
| 1: | 10.7x | ↗ |
| 2: | 9.6 | ↓ |
| 3: | 10.1 | ↓ |
| 4: | 10.1 | ↗ |
| 5: | 10.1 | ↗ |
| Serie | | 50.6 |
| Total | | 149.1 |

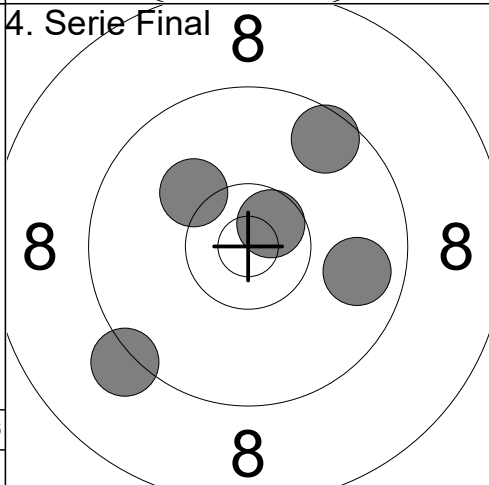

| | | |
|-------|-------|-------|
| 1: | 10.2 | ↖ |
| 2: | 9.6 | ↗ |
| 3: | 9.8 | → |
| 4: | 10.6x | ↗ |
| 5: | 9.2 | ↖ |
| Serie | | 49.4 |
| Total | | 198.5 |

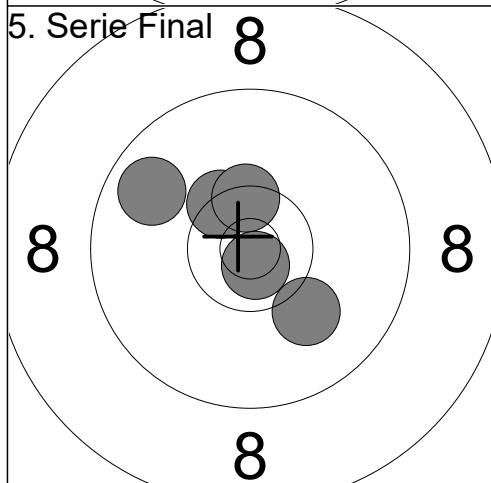

| | | |
|-------|-------|-------|
| 1: | 10.4x | ↗ |
| 2: | 10.1 | ↘ |
| 3: | 10.4x | ↗ |
| 4: | 10.8x | ↘ |
| 5: | 9.8 | ↗ |
| Serie | | 51.5 |
| Total | | 250.0 |

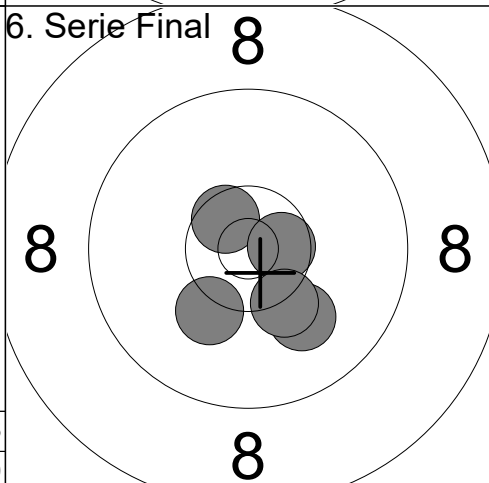

| | | |
|-------|-------|-------|
| 1: | 10.1 | ↘ |
| 2: | 10.6x | ↗ |
| 3: | 10.6x | → |
| 4: | 10.2 | ↘ |
| 5: | 10.3 | ↘ |
| Serie | | 51.8 |
| Total | | 301.8 |

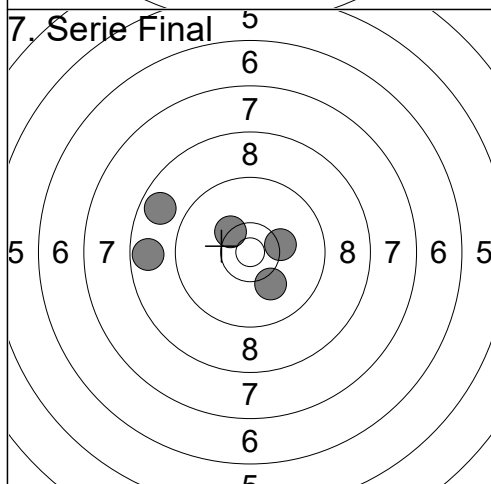

| | | |
|-------|-------|-------|
| 1: | 10.3x | ↗ |
| 2: | 10.3 | → |
| 3: | 8.7 | ↖ |
| 4: | 10.1 | ↘ |
| 5: | 8.7 | ← |
| Serie | | 48.1 |
| Total | | 349.9 |

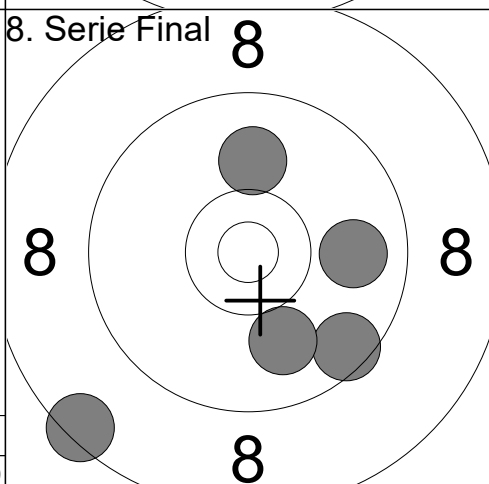

| | | |
|-------|------|-------|
| 1: | 9.5 | ↘ |
| 2: | 8.4 | ↖ |
| 3: | 9.9 | → |
| 4: | 10.0 | ↘ |
| 5: | 10.0 | ↗ |
| Serie | | 47.8 |
| Total | | 397.7 |

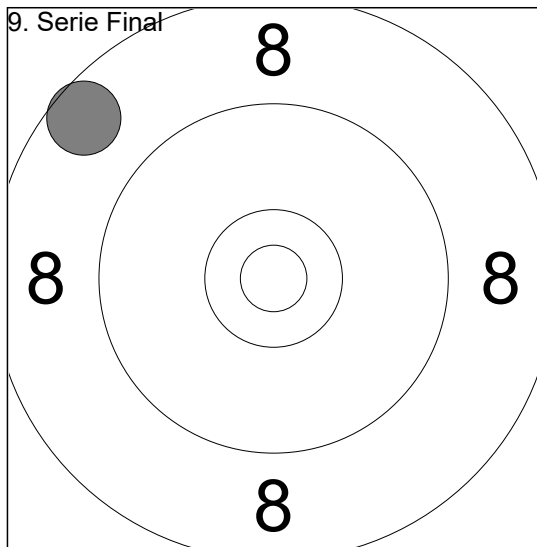

1: 8.6 ↖

| | |
|-------|-------|
| Serie | 8.6 |
| Total | 406.3 |

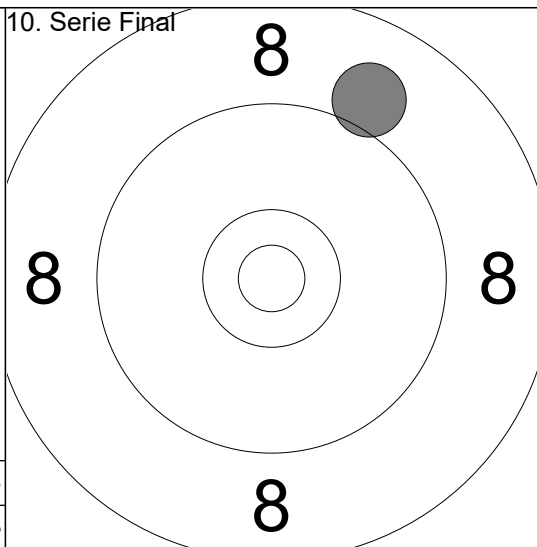

1: 9.0 ↗

| | |
|-------|-------|
| Serie | 9.0 |
| Total | 415.3 |

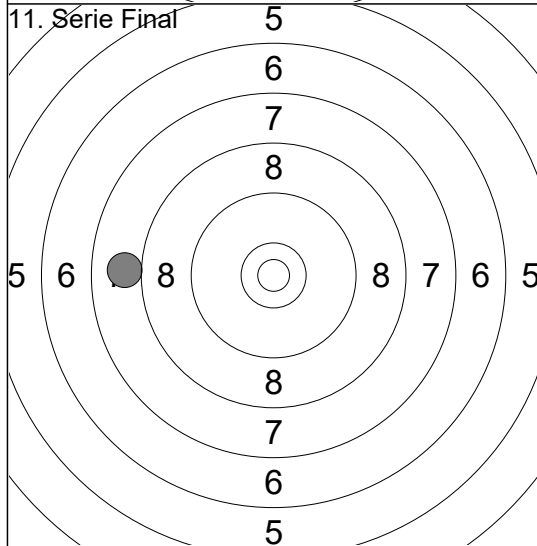

1: 8.0 ←

| | |
|-------|-------|
| Serie | 8.0 |
| Total | 423.3 |

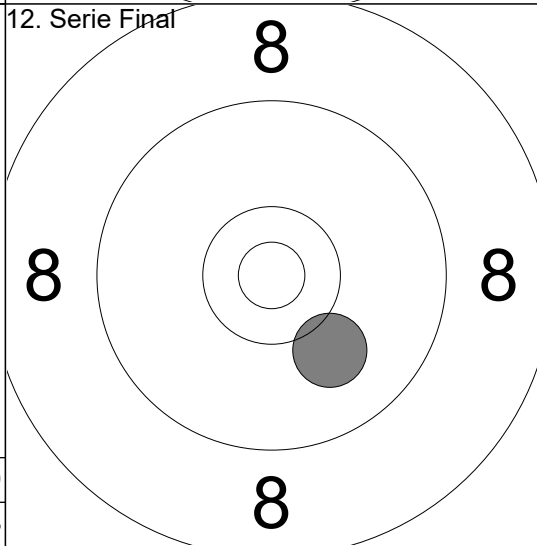

1: 10.1 ↘

| | |
|-------|-------|
| Serie | 10.1 |
| Total | 433.4 |

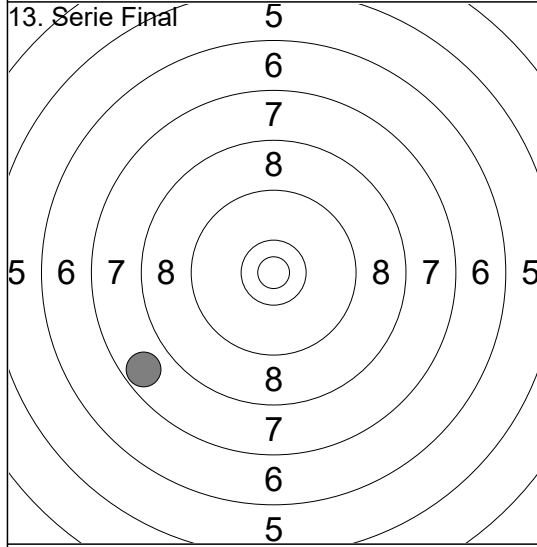

1: 7.7 ↙

| | |
|-------|-------|
| Serie | 7.7 |
| Total | 441.1 |

| | |
|--|--|
| | |
|--|--|

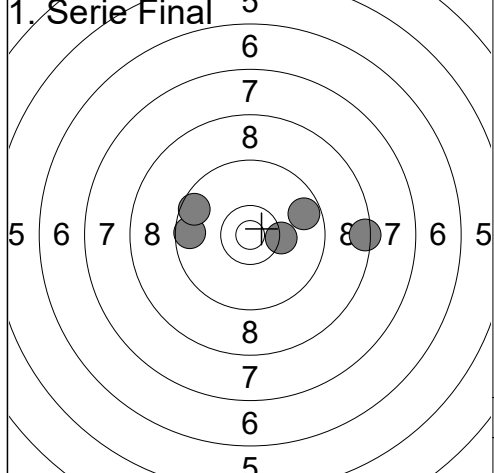

| | | |
|-------|------|------|
| 1: | 9.6 | ← |
| 2: | 8.4 | → |
| 3: | 9.6 | ↖ |
| 4: | 9.7 | → |
| 5: | 10.3 | → |
| Serie | | 47.6 |
| Total | | 47.6 |

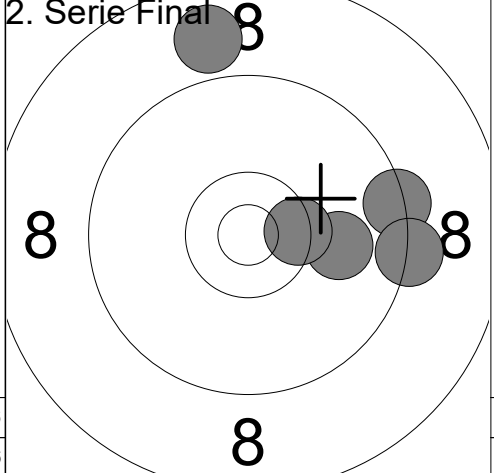

| | | |
|-------|-------|------|
| 1: | 8.9 | ↑ |
| 2: | 9.4 | → |
| 3: | 9.3 | → |
| 4: | 10.0 | → |
| 5: | 10.4x | → |
| Serie | | 48.0 |
| Total | | 95.6 |

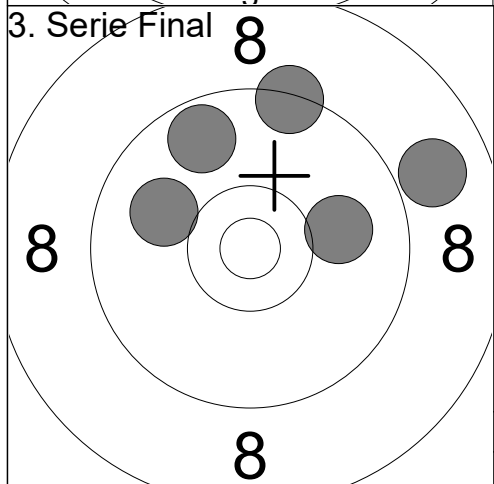

| | | |
|-------|------|-------|
| 1: | 8.9 | → |
| 2: | 10.0 | ↖ |
| 3: | 10.0 | → |
| 4: | 9.7 | ↗ |
| 5: | 9.4 | ↑ |
| Serie | | 48.0 |
| Total | | 143.6 |

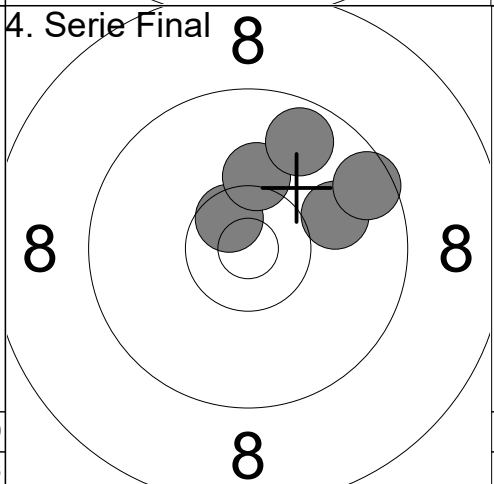

| | | |
|-------|-------|-------|
| 1: | 10.6x | ↖ |
| 2: | 10.2 | ↑ |
| 3: | 10.0 | → |
| 4: | 9.6 | ↗ |
| 5: | 9.7 | ↗ |
| Serie | | 50.1 |
| Total | | 193.7 |

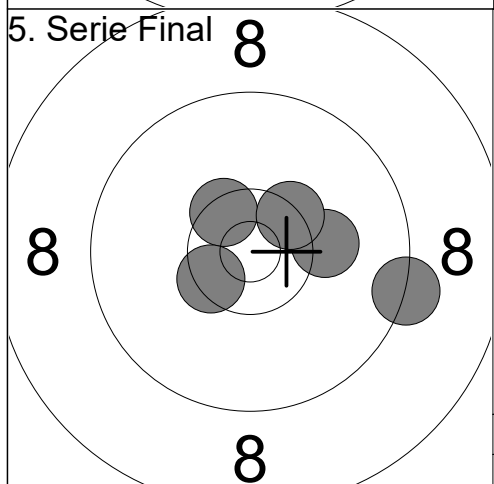

| | | |
|-------|-------|-------|
| 1: | 10.5x | ↖ |
| 2: | 10.2 | → |
| 3: | 10.4x | ↗ |
| 4: | 10.5x | ↖ |
| 5: | 9.3 | → |
| Serie | | 50.9 |
| Total | | 244.6 |

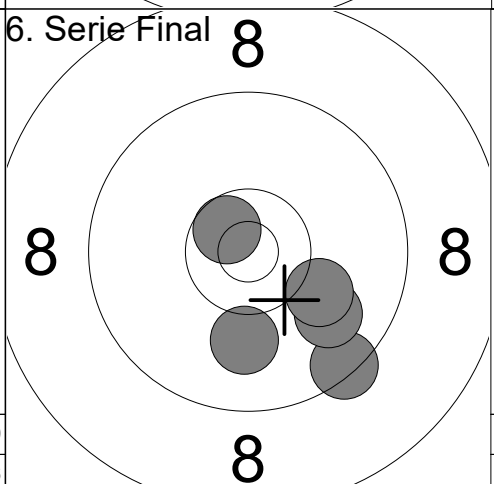

| | | |
|-------|-------|-------|
| 1: | 9.4 | ↘ |
| 2: | 10.6x | ↗ |
| 3: | 10.0 | ↘ |
| 4: | 9.9 | ↘ |
| 5: | 10.1 | ↘ |
| Serie | | 50.0 |
| Total | | 294.6 |

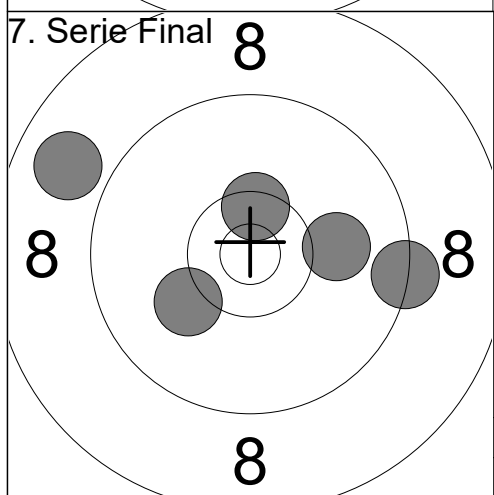

| | | |
|-------|-------|-------|
| 1: | 10.1 | → |
| 2: | 8.9 | ↖ |
| 3: | 10.5x | ↑ |
| 4: | 10.1 | ↖ |
| 5: | 9.3 | → |
| Serie | | 48.9 |
| Total | | 343.5 |

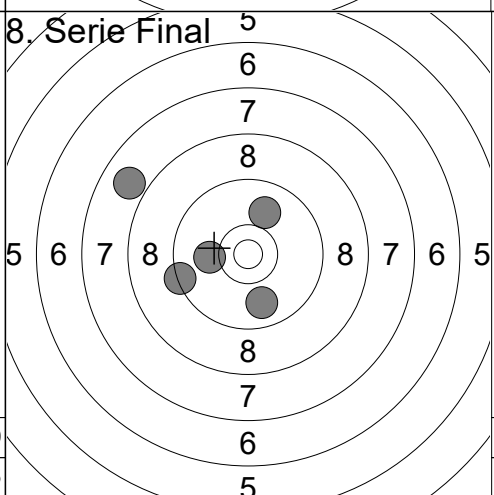

| | | |
|-------|------|-------|
| 1: | 10.0 | ↑ |
| 2: | 9.4 | ← |
| 3: | 10.1 | ← |
| 4: | 7.9 | ↖ |
| 5: | 9.9 | ↘ |
| Serie | | 47.3 |
| Total | | 390.8 |

9. Serie Final

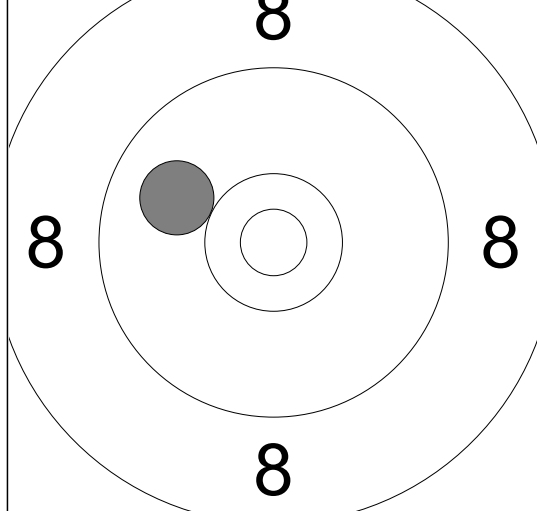

| | |
|-------|-------|
| Serie | 9.9 |
| Total | 400.7 |

10. Serie Final

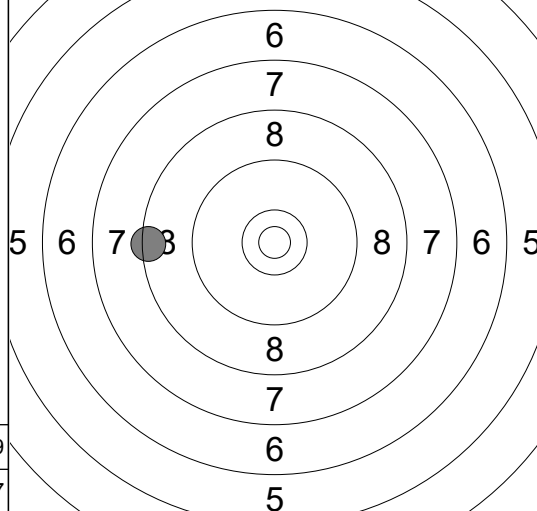

| | |
|-------|-------|
| Serie | 8.4 |
| Total | 409.1 |

11. Serie Final

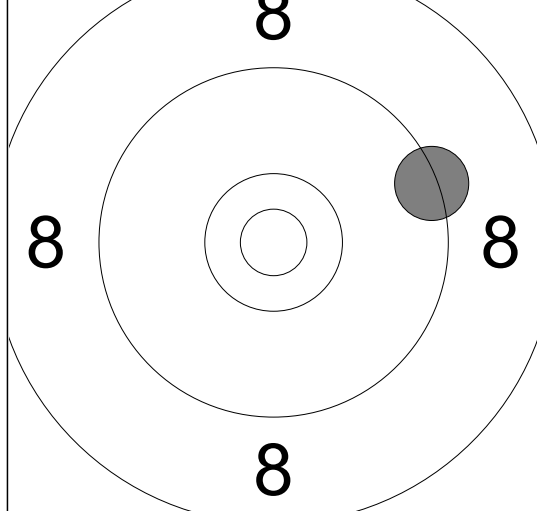

| | |
|-------|-------|
| Serie | 9.4 |
| Total | 418.5 |

12. Serie Final

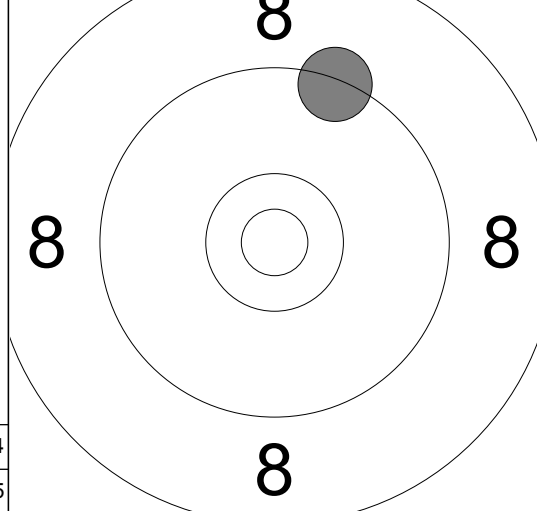

| | |
|-------|-------|
| Serie | 9.4 |
| Total | 427.9 |

13. Serie Final

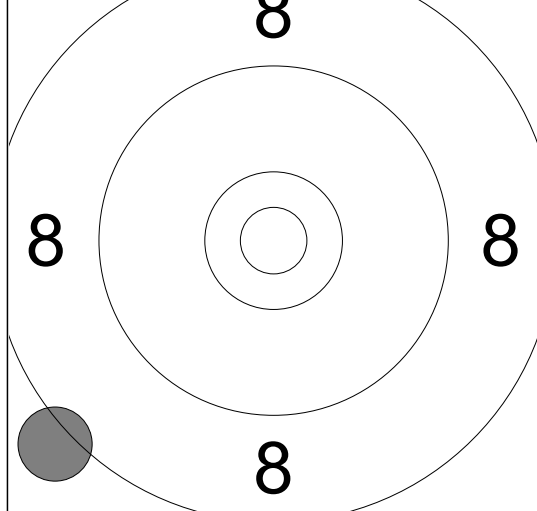

| | |
|-------|-------|
| Serie | 8.1 |
| Total | 436.0 |

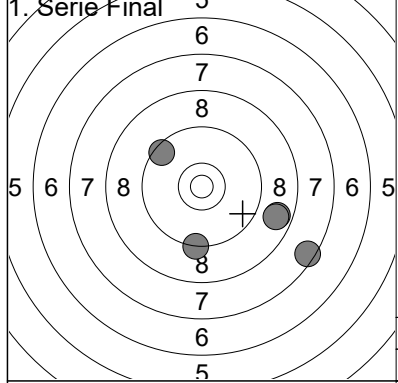
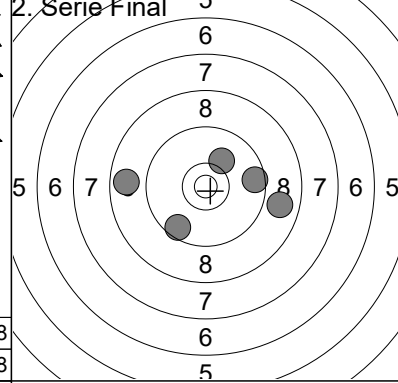
| | | | |
|---|--|---|---|
| 1. Serie Final  | 1: 9.5 ↗ 2: 7.5 ↘ 3: 8.7 ↘ 4: 9.3 ↘ 5: 8.8 ↘ | 2. Serie Final  | 1: 10.1 ↗ 2: 9.6 ↘ 3: 9.6 → 4: 8.9 → 5: 8.8 ← |
| Serie 43.8 | Total 43.8 | Serie 47.0 | Total 90.8 |

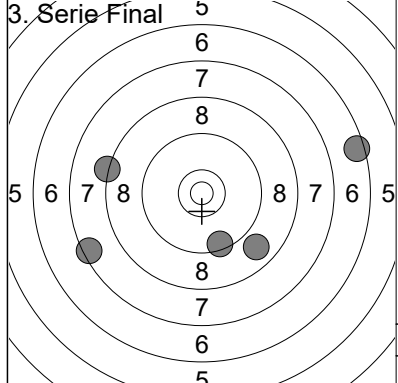
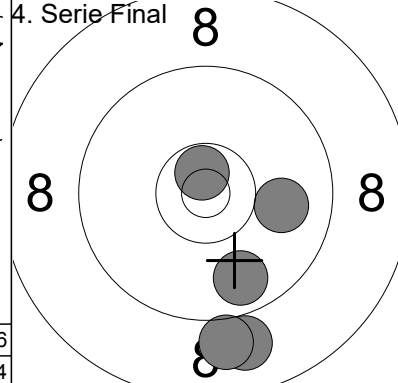
| | | | |
|---|--|---|---|
| 3. Serie Final  | 1: 8.3 ← 2: 6.5 → 3: 8.8 ↘ 4: 9.5 ↘ 5: 7.5 ↙ | 4. Serie Final  | 1: 8.9 ↘ 2: 9.0 ↘ 3: 10.0 → 4: 10.7x ↑ 5: 9.8 ↘ |
| Serie 40.6 | Total 131.4 | Serie 48.4 | Total 179.8 |

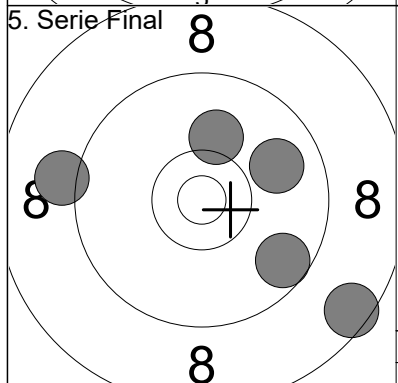
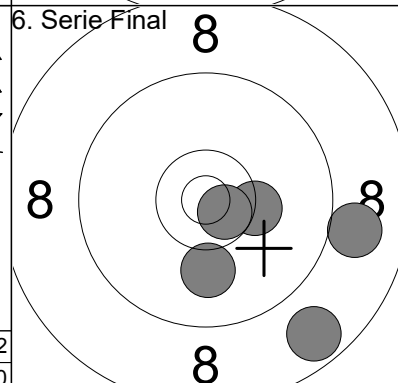
| | | | |
|--|---|--|---|
| 5. Serie Final  | 1: 10.1 ↑ 2: 9.6 ↘ 3: 8.5 ↘ 4: 9.9 → 5: 9.1 ↑ | 6. Serie Final  | 1: 9.0 → 2: 10.0 ↘ 3: 10.3x → 4: 10.7x ↘ 5: 8.7 ↘ |
| Serie 47.2 | Total 227.0 | Serie 48.7 | Total 275.7 |

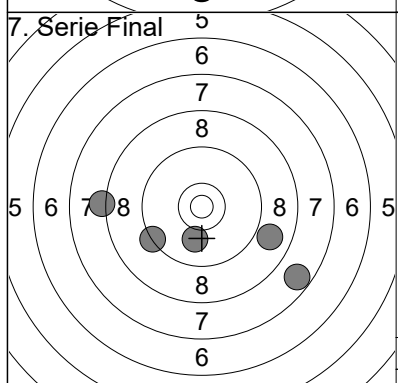
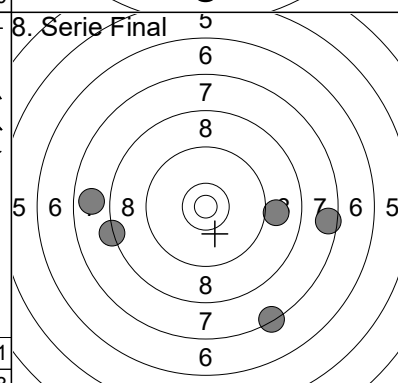
| | | | |
|---|---|---|--|
| 7. Serie Final  | 1: 8.2 ← 2: 10.0 ↘ 3: 7.7 ↘ 4: 8.9 ↘ 5: 9.3 ↙ | 8. Serie Final  | 1: 7.4 ↘ 2: 9.0 → 3: 8.3 ← 4: 7.8 ← 5: 7.5 → |
| Serie 44.1 | Total 319.8 | Serie 40.0 | Total 359.8 |

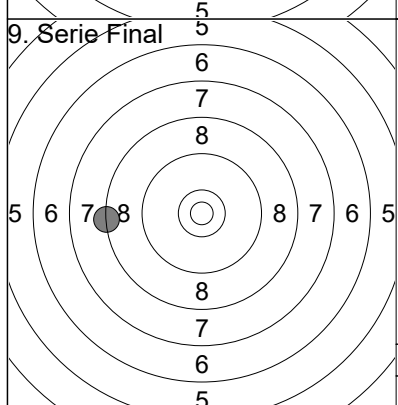
| | | | |
|---|-------------|--|--|
| 9. Serie Final  | 1: 8.3 ← | | |
| Serie 8.3 | Total 368.1 | | |

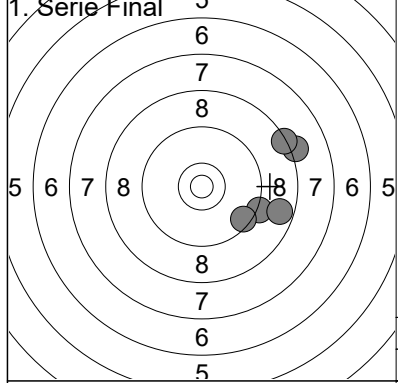

| | | |
|-------|------|---|
| 1: | 9.2 | ↘ |
| 2: | 8.2 | → |
| 3: | 8.4 | → |
| 4: | 8.7 | ↘ |
| 5: | 9.5 | ↘ |
| | | |
| Serie | 44.0 | |
| Total | 44.0 | |

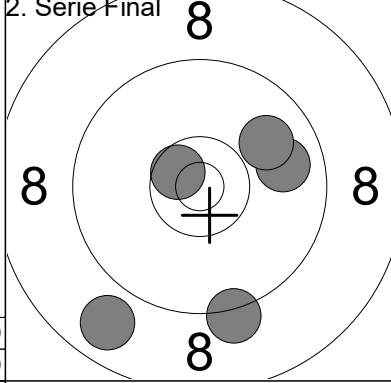

| | | |
|-------|-------|---|
| 1: | 9.2 | ↘ |
| 2: | 10.6x | ↗ |
| 3: | 9.8 | → |
| 4: | 9.9 | ↗ |
| 5: | 8.8 | ↘ |
| | | |
| Serie | 48.3 | |
| Total | 92.3 | |

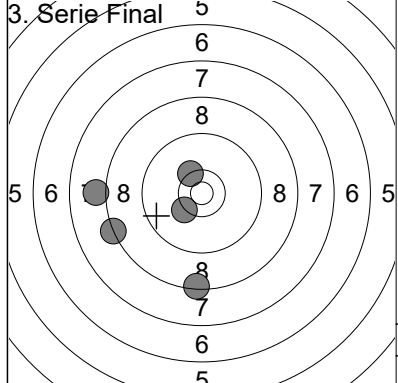

| | | |
|-------|-------|---|
| 1: | 8.0 | ← |
| 2: | 10.3x | ↘ |
| 3: | 8.4 | ↘ |
| 4: | 10.3x | ↗ |
| 5: | 8.3 | ↖ |
| | | |
| Serie | 45.3 | |
| Total | 137.6 | |

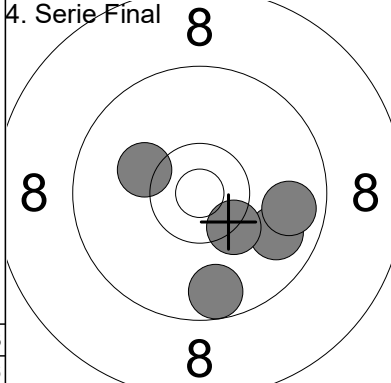

| | | |
|-------|-------|---|
| 1: | 9.8 | ↘ |
| 2: | 10.2 | ↗ |
| 3: | 10.3x | ↘ |
| 4: | 9.8 | → |
| 5: | 9.7 | ↘ |
| | | |
| Serie | 49.8 | |
| Total | 187.4 | |

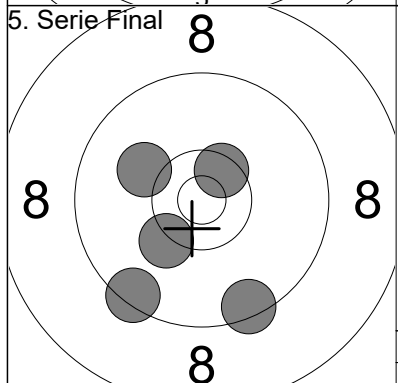

| | | |
|-------|-------|---|
| 1: | 10.1 | ↗ |
| 2: | 9.4 | ↘ |
| 3: | 9.4 | ↘ |
| 4: | 10.5x | ↗ |
| 5: | 10.2 | ↘ |
| | | |
| Serie | 49.6 | |
| Total | 237.0 | |

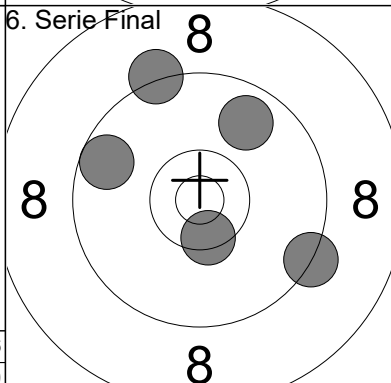

| | | |
|-------|-------|---|
| 1: | 9.6 | ↗ |
| 2: | 9.2 | ↗ |
| 3: | 9.3 | ↘ |
| 4: | 9.8 | ↗ |
| 5: | 10.5x | ↘ |
| | | |
| Serie | 48.4 | |
| Total | 285.4 | |

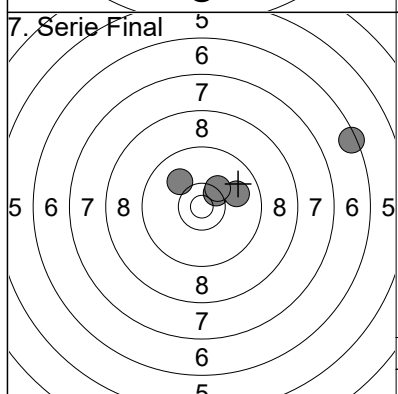

| | | |
|-------|-------|---|
| 1: | 6.4 | → |
| 2: | 10.4x | ↗ |
| 3: | 9.9 | → |
| 4: | 10.3 | ↗ |
| 5: | 10.0 | ↗ |
| | | |
| Serie | 47.0 | |
| Total | 332.4 | |

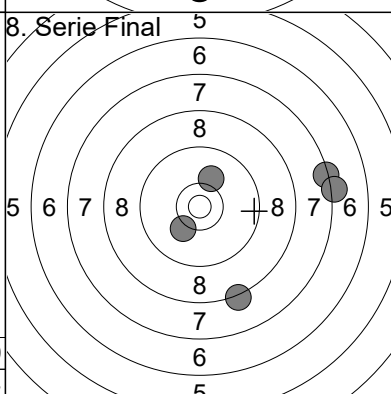

| | | |
|-------|-------|---|
| 1: | 7.4 | → |
| 2: | 10.2 | ↘ |
| 3: | 10.1 | ↗ |
| 4: | 7.2 | → |
| 5: | 8.2 | ↘ |
| | | |
| Serie | 43.1 | |
| Total | 375.5 | |

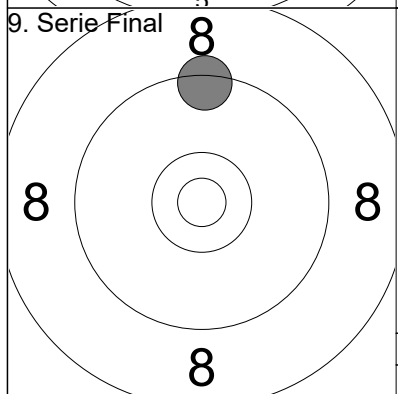

| | | |
|-------|-------|---|
| 1: | 9.4 | ↑ |
| | | |
| Serie | 9.4 | |
| Total | 384.9 | |

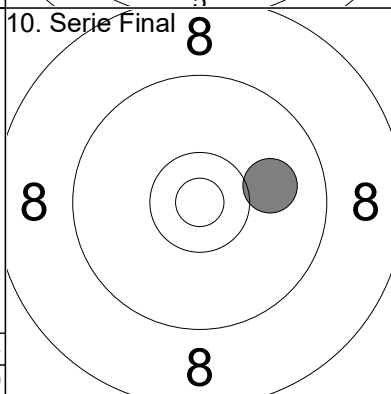

| | | |
|-------|-------|---|
| 1: | 10.0 | → |
| | | |
| Serie | 10.0 | |
| Total | 394.9 | |

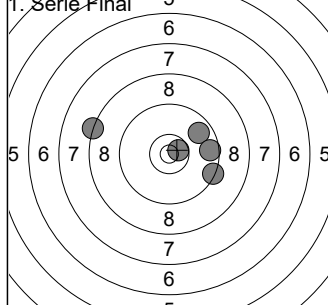
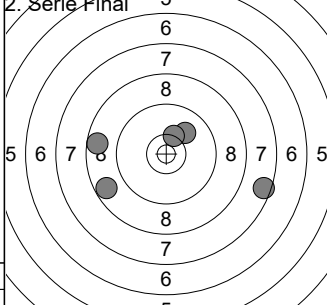
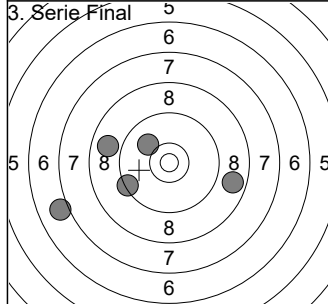
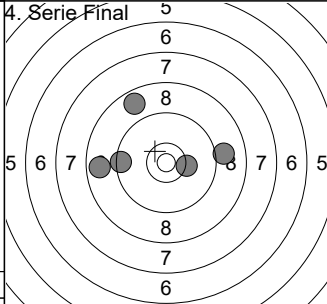
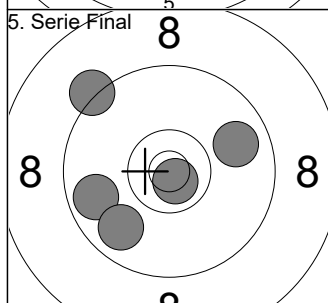
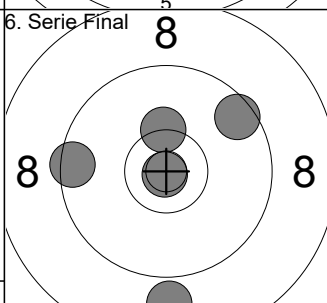
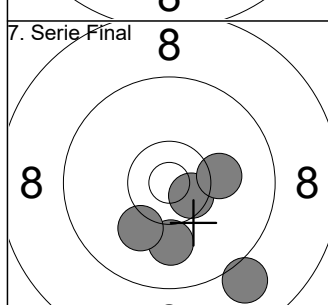
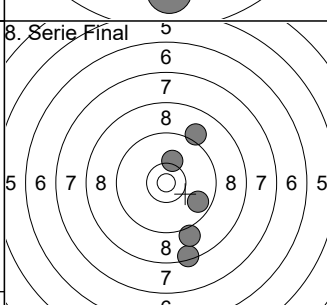
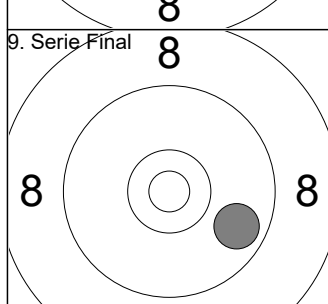
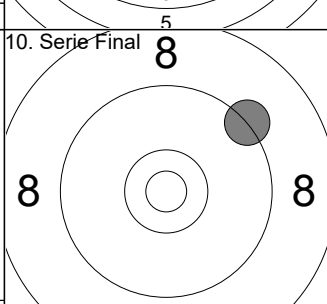
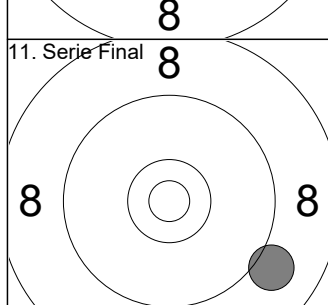
| | | | |
|--|---|--|--|
| 1. Serie Final  | 1: 10.6x → 2: 8.3 ↗ 3: 9.7 ↗ 4: 9.4 ↘ 5: 9.6 → | 2. Serie Final  | 1: 8.7 ↙ 2: 8.6 ← 3: 7.5 → 4: 10.0 ↗ 5: 10.3x ↗ |
| | Serie 47.6 Total 47.6 | | Serie 45.1 Total 92.7 |
| 3. Serie Final  | 1: 9.4 ↙ 2: 7.0 ← 3: 8.8 ↗ 4: 8.7 → 5: 10.0 ↗ | 4. Serie Final  | 1: 9.0 → 2: 8.7 ↗ 3: 10.3 → 4: 9.5 ← 5: 8.8 ← |
| | Serie 43.9 Total 136.6 | | Serie 46.3 Total 182.9 |
| 5. Serie Final  | 1: 9.7 ↙ 2: 10.8x ↙ 3: 9.8 ↙ 4: 9.2 ↗ 5: 9.8 ↘ | 6. Serie Final  | 1: 10.3x ↑ 2: 9.5 ← 3: 10.9x ↙ 4: 9.6 ↗ 5: 8.9 ↓ |
| | Serie 49.3 Total 232.2 | | Serie 49.2 Total 281.4 |
| 7. Serie Final  | 1: 10.6x → 2: 10.2 → 3: 10.0 → 4: 10.1 ↙ 5: 9.0 ↓ | 8. Serie Final  | 1: 8.4 ↓ 2: 9.7 ↘ 3: 9.1 ↗ 4: 9.0 ↘ 5: 10.2 ↗ |
| | Serie 49.9 Total 331.3 | | Serie 46.4 Total 377.7 |
| 9. Serie Final  | 1: 9.8 → | 10. Serie Final  | 1: 9.3 ↗ |
| | Serie 9.8 Total 387.5 | | Serie 9.3 Total 396.8 |
| 11. Serie Final  | 1: 9.0 → | | |
| | Serie 9.0 Total 405.8 | | |

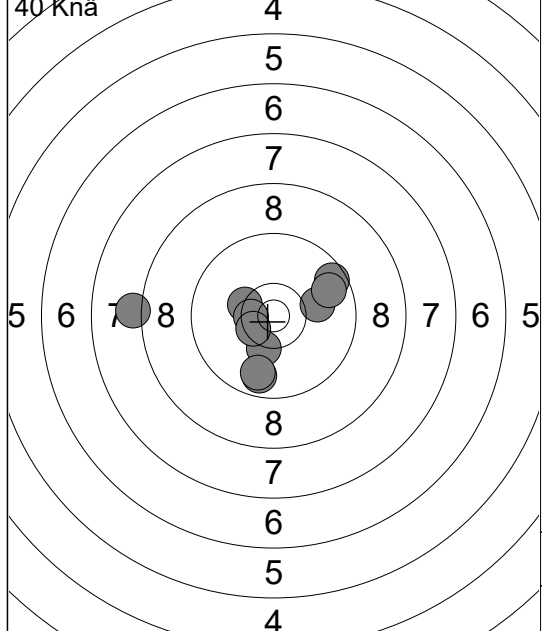

| | | |
|-------|------|------|
| 1: | 9.7 | ↓ |
| 2: | 10.3 | ↓ |
| 3: | 9.8 | ↓ |
| 4: | 9.6 | ↗ |
| 5: | 10.0 | → |
| 6: | 10.3 | ↖ |
| 7: | 8.1 | ← |
| 8: | 9.7 | ↗ |
| 9: | 10.5 | ↖ |
| 10: | 10.5 | ↖ |
| Serie | | 94.0 |
| Total | | 94.0 |

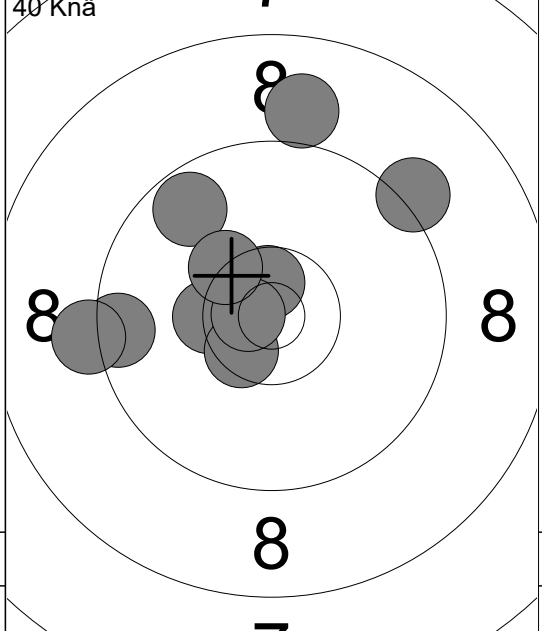

| | | |
|-------|------|-------|
| 11: | 9.5 | ← |
| 12: | 9.2 | ← |
| 13: | 10.6 | ↗ |
| 14: | 10.4 | ↖ |
| 15: | 9.2 | ↗ |
| 16: | 10.5 | ↖ |
| 17: | 9.7 | ↖ |
| 18: | 10.7 | ↖ |
| 19: | 9.0 | ↑ |
| 20: | 10.3 | ↖ |
| Serie | | 95.0 |
| Total | | 189.0 |

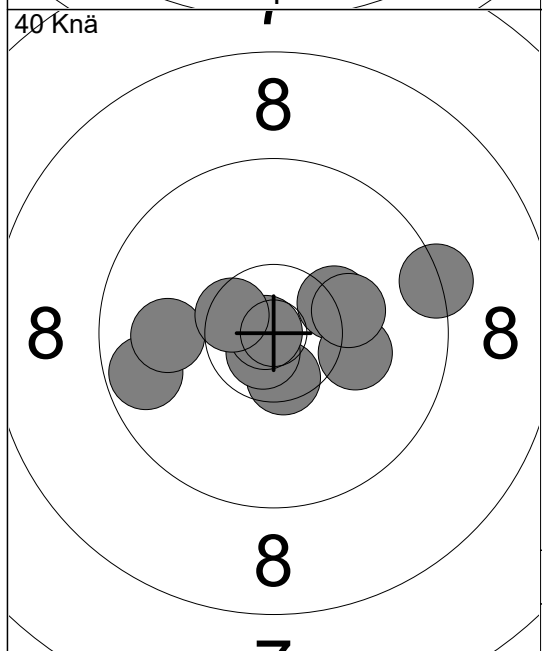

| | | |
|-------|------|-------|
| 21: | 10.3 | ↗ |
| 22: | 9.3 | → |
| 23: | 10.2 | → |
| 24: | 9.7 | ← |
| 25: | 10.2 | → |
| 26: | 10.5 | ↖ |
| 27: | 9.9 | ← |
| 28: | 10.7 | ↖ |
| 29: | 10.9 | ↖ |
| 30: | 10.5 | ↖ |
| Serie | | 97.0 |
| Total | | 286.0 |

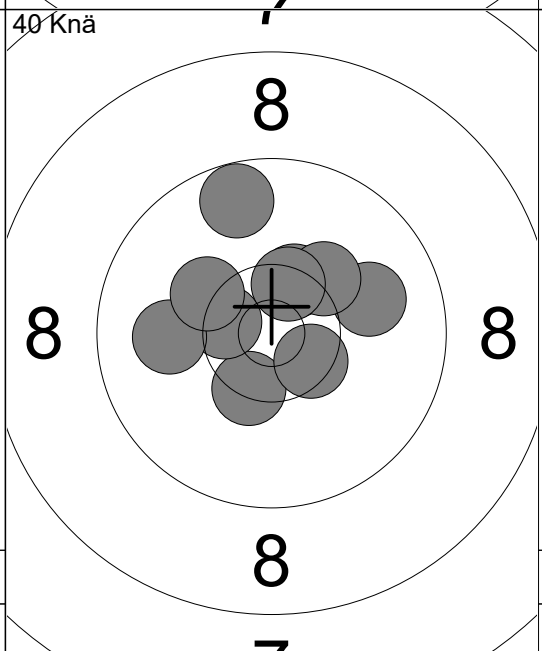

| | | |
|-------|------|-------|
| 31: | 10.4 | ↖ |
| 32: | 10.4 | ↗ |
| 33: | 9.7 | ↑ |
| 34: | 10.5 | ↖ |
| 35: | 10.0 | → |
| 36: | 10.2 | ↗ |
| 37: | 10.5 | ↗ |
| 38: | 10.5 | ↖ |
| 39: | 10.0 | ← |
| 40: | 10.2 | ↖ |
| Serie | | 99.0 |
| Total | | 385.0 |

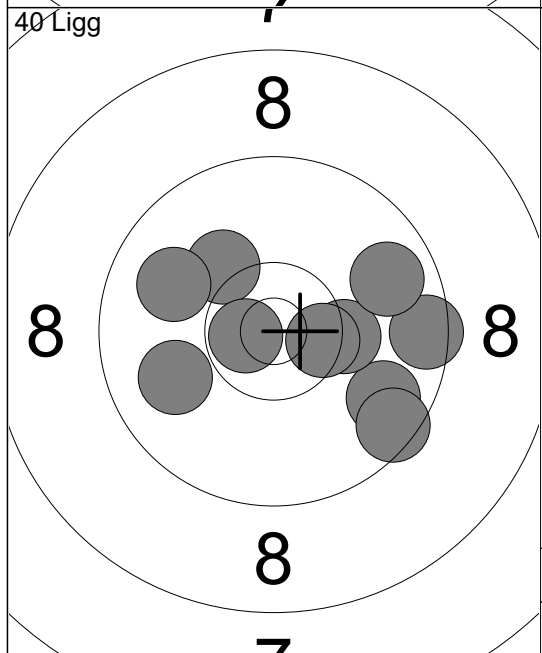

| | | |
|-------|------|-------|
| 1: | 10.2 | ↖ |
| 2: | 9.7 | ↗ |
| 3: | 9.9 | ← |
| 4: | 9.5 | → |
| 5: | 10.3 | ↗ |
| 6: | 10.5 | ↗ |
| 7: | 9.8 | ↗ |
| 8: | 9.5 | ↖ |
| 9: | 10.7 | ↖ |
| 10: | 9.9 | ← |
| Serie | | 94.0 |
| Total | | 479.0 |

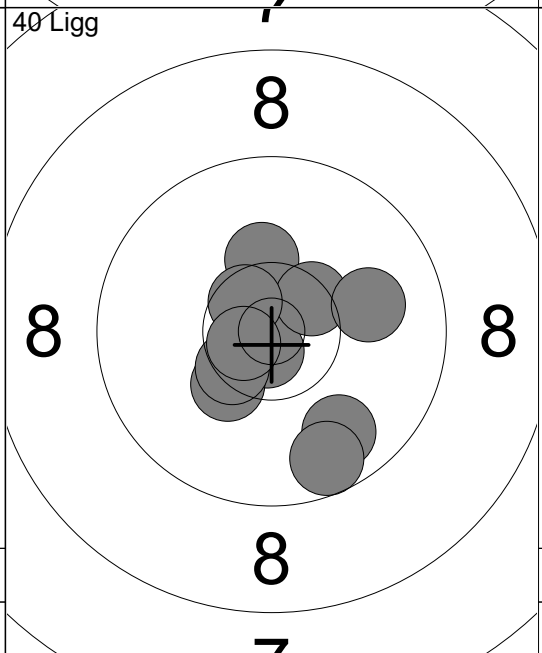

| | | |
|-------|------|-------|
| 11: | 10.8 | ↖ |
| 12: | 10.3 | ↑ |
| 13: | 10.3 | ↖ |
| 14: | 10.5 | ↗ |
| 15: | 10.5 | ↖ |
| 16: | 9.8 | ↖ |
| 17: | 10.0 | → |
| 18: | 9.6 | ↖ |
| 19: | 10.6 | ↖ |
| 20: | 10.7 | ↖ |
| Serie | | 98.0 |
| Total | | 577.0 |

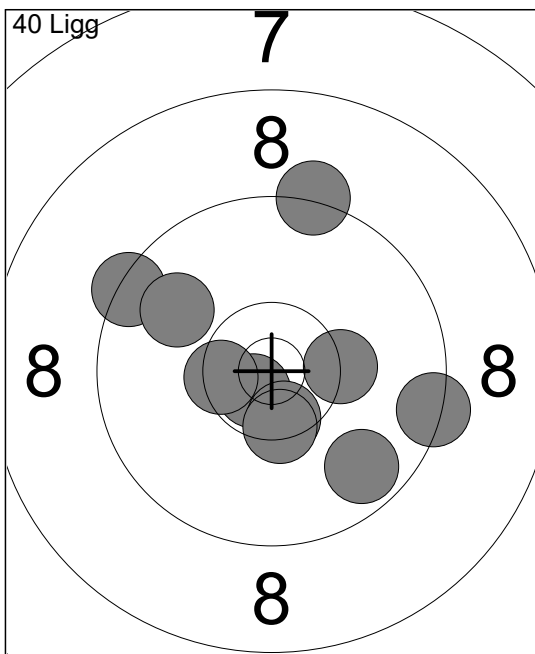

| | | |
|-------|-------|----|
| 21: | 9.4 | ↖ |
| 22: | 10.7 | ✗ |
| 23: | 9.9 | ↖ |
| 24: | 9.4 | → |
| 25: | 10.3 | x→ |
| 26: | 10.5 | x↓ |
| 27: | 10.5 | x← |
| 28: | 10.4 | x↓ |
| 29: | 9.3 | ↑ |
| 30: | 9.7 | ↘ |
| Serie | 95.0 | |
| Total | 672.0 | |

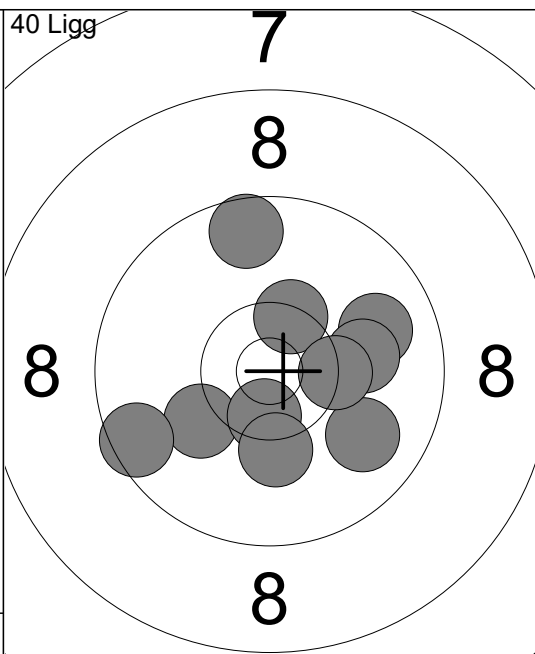

| | | |
|-------|-------|----|
| 31: | 9.9 | → |
| 32: | 9.6 | ↑ |
| 33: | 10.1 | ↙ |
| 34: | 10.4 | x↗ |
| 35: | 10.5 | x↓ |
| 36: | 10.1 | → |
| 37: | 9.5 | ↖ |
| 38: | 9.9 | ↘ |
| 39: | 10.2 | ↓ |
| 40: | 10.3 | x→ |
| Serie | 96.0 | |
| Total | 768.0 | |

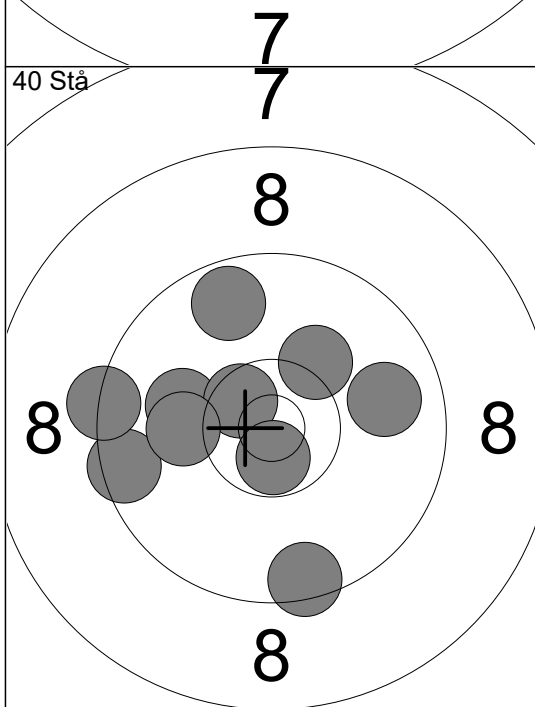

| | | |
|-------|-------|----|
| 1: | 10.2 | ↗ |
| 2: | 10.1 | ↖ |
| 3: | 9.9 | → |
| 4: | 9.5 | ↖ |
| 5: | 9.7 | ↑ |
| 6: | 10.6 | x↖ |
| 7: | 9.5 | ↓ |
| 8: | 9.3 | ↖ |
| 9: | 10.7 | x↓ |
| 10: | 10.1 | ↖ |
| Serie | 95.0 | |
| Total | 863.0 | |

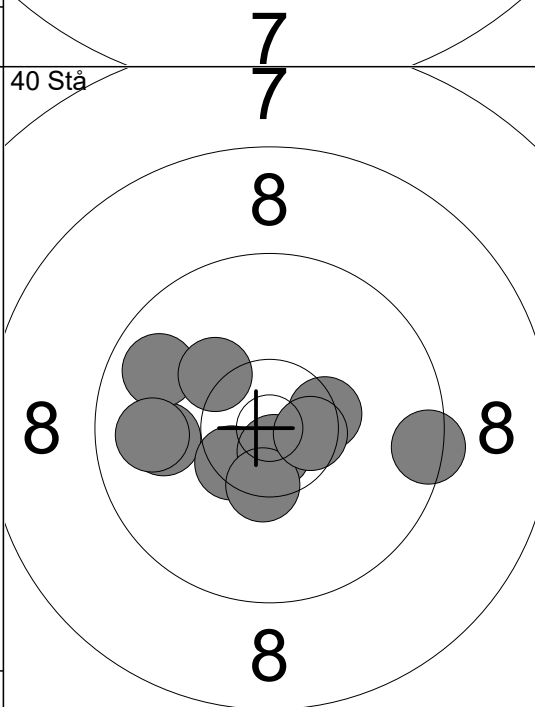

| | | |
|-------|-------|----|
| 11: | 9.9 | ↖ |
| 12: | 9.8 | ↖ |
| 13: | 10.5 | x↖ |
| 14: | 10.7 | x↓ |
| 15: | 9.4 | → |
| 16: | 10.4 | x↓ |
| 17: | 10.2 | ↖ |
| 18: | 10.4 | x→ |
| 19: | 10.6 | x→ |
| 20: | 9.8 | ↖ |
| Serie | 96.0 | |
| Total | 959.0 | |

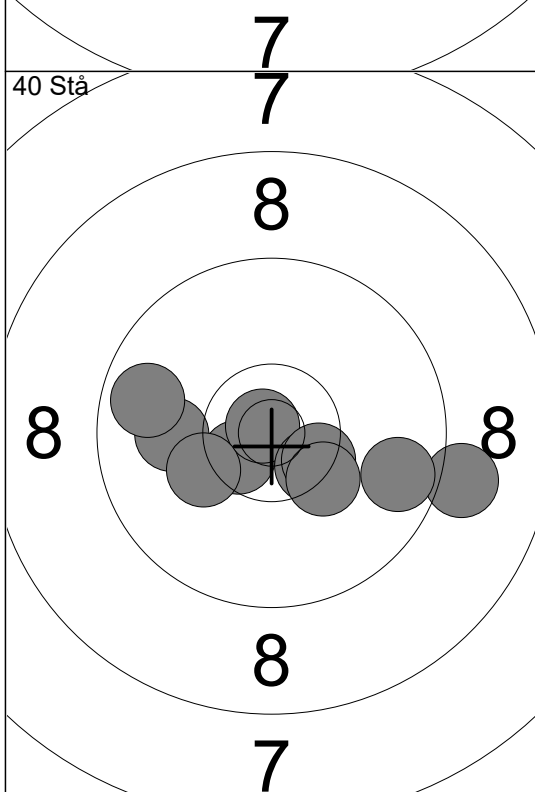

| | | |
|-------|--------|----|
| 21: | 10.0 | ↖ |
| 22: | 10.6 | x↖ |
| 23: | 10.8 | x↖ |
| 24: | 9.1 | → |
| 25: | 9.7 | ↖ |
| 26: | 10.5 | x↖ |
| 27: | 10.4 | x↖ |
| 28: | 9.7 | → |
| 29: | 10.2 | ↙ |
| 30: | 10.3 | x↖ |
| Serie | 97.0 | |
| Total | 1056.0 | |

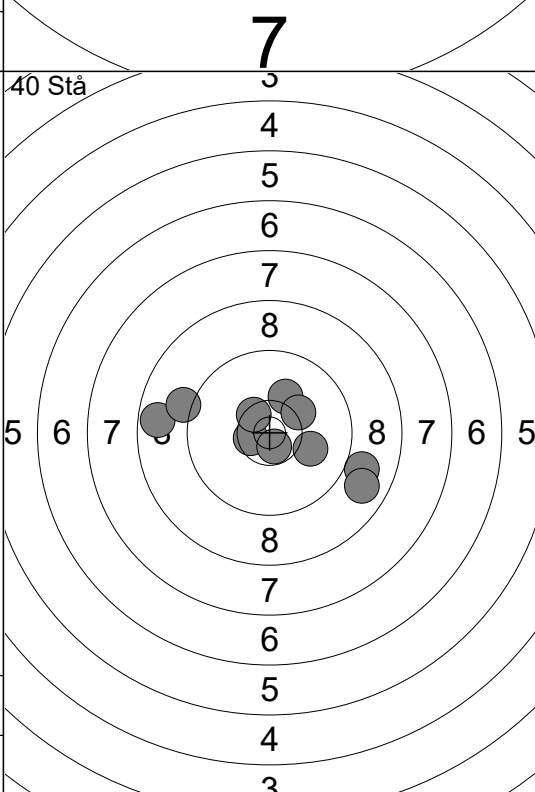

| | | |
|-------|--------|----|
| 31: | 10.6 | x↖ |
| 32: | 8.7 | ↖ |
| 33: | 10.7 | x↓ |
| 34: | 9.1 | ↖ |
| 35: | 9.0 | → |
| 36: | 10.5 | x↖ |
| 37: | 10.2 | ↗ |
| 38: | 8.8 | ↘ |
| 39: | 10.1 | → |
| 40: | 10.2 | ↗ |
| Serie | 94.0 | |
| Total | 1150.0 | |

| | | |
|--------------------|--|--|
| Granngården | | |
|--------------------|--|--|

| | | |
|-------------------|----------------------------|-------------------------|
| 05.05.2018 | Trolltåffen/GP 2018 | Trollhättans SKF |
|-------------------|----------------------------|-------------------------|

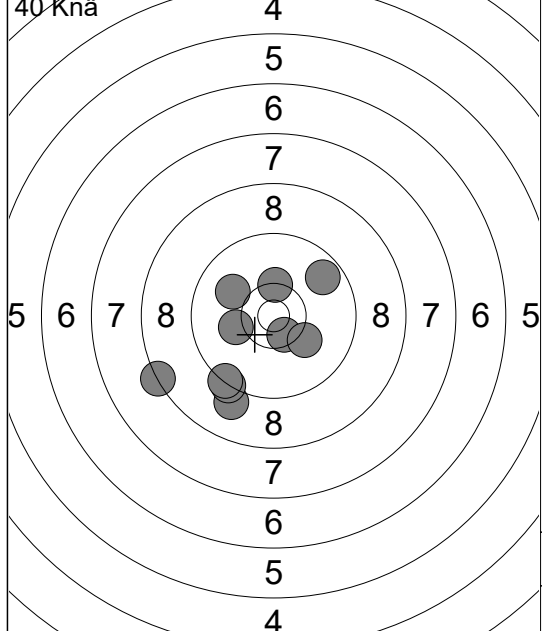

| | | |
|-------|------|------|
| 1: | 9.0 | ↘ |
| 2: | 8.3 | ↙ |
| 3: | 10.5 | ↘ |
| 4: | 9.7 | ↗ |
| 5: | 10.3 | ↗ |
| 6: | 10.2 | ↘ |
| 7: | 10.0 | ↙ |
| 8: | 9.3 | ↘ |
| 9: | 9.3 | ↘ |
| 10: | 10.2 | ↙ |
| Serie | | 94.0 |
| Total | | 94.0 |

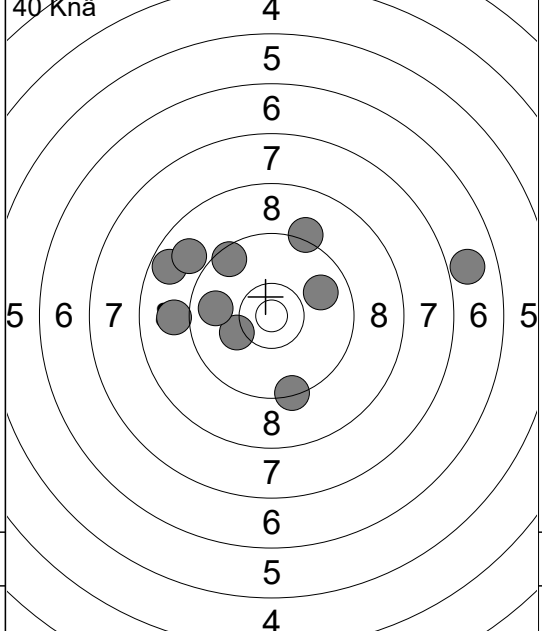

| | | |
|-------|------|-------|
| 11: | 8.7 | ↖ |
| 12: | 8.9 | ↖ |
| 13: | 10.2 | ↙ |
| 14: | 9.5 | ↗ |
| 15: | 9.3 | ↘ |
| 16: | 6.9 | → |
| 17: | 9.8 | ← |
| 18: | 9.9 | ↗ |
| 19: | 9.0 | ← |
| 20: | 9.2 | ↗ |
| Serie | | 86.0 |
| Total | | 180.0 |

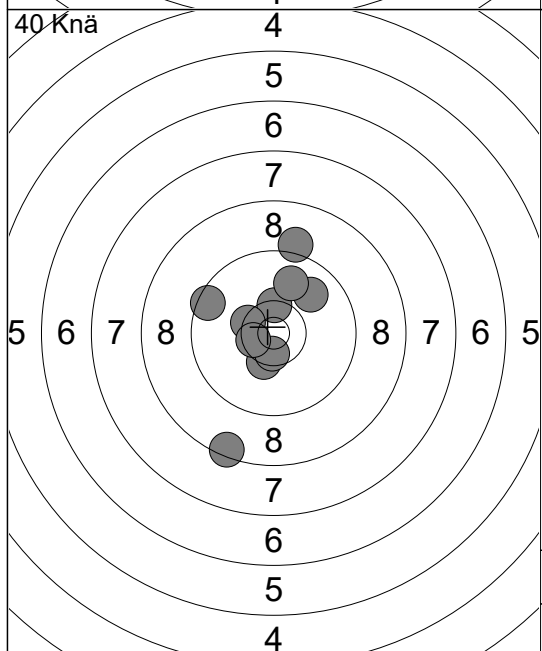

| | | |
|-------|------|-------|
| 21: | 10.3 | ↘ |
| 22: | 10.4 | ↗ |
| 23: | 10.5 | ↘ |
| 24: | 8.4 | ↘ |
| 25: | 9.1 | ↗ |
| 26: | 9.9 | ↗ |
| 27: | 9.5 | ↙ |
| 28: | 10.4 | ↙ |
| 29: | 10.5 | ↙ |
| 30: | 9.9 | ↗ |
| Serie | | 94.0 |
| Total | | 274.0 |

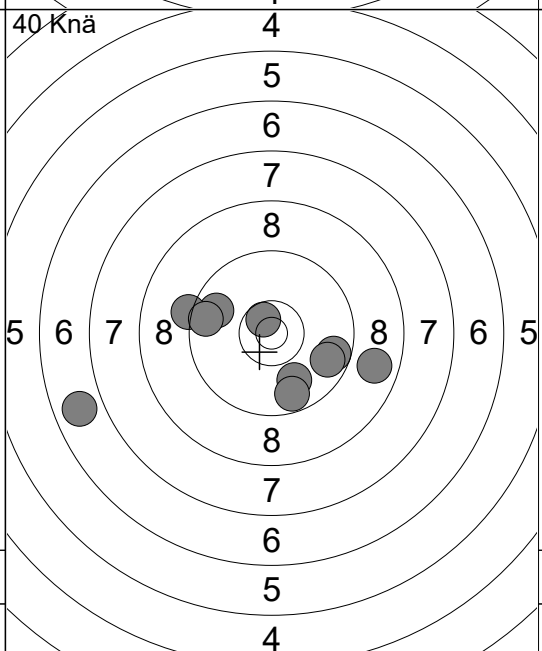

| | | |
|-------|------|-------|
| 31: | 8.8 | → |
| 32: | 9.6 | → |
| 33: | 9.7 | ↙ |
| 34: | 9.2 | ← |
| 35: | 9.9 | ↘ |
| 36: | 10.6 | ↘ |
| 37: | 9.7 | → |
| 38: | 9.6 | ← |
| 39: | 6.8 | ← |
| 40: | 9.7 | ↘ |
| Serie | | 87.0 |
| Total | | 361.0 |

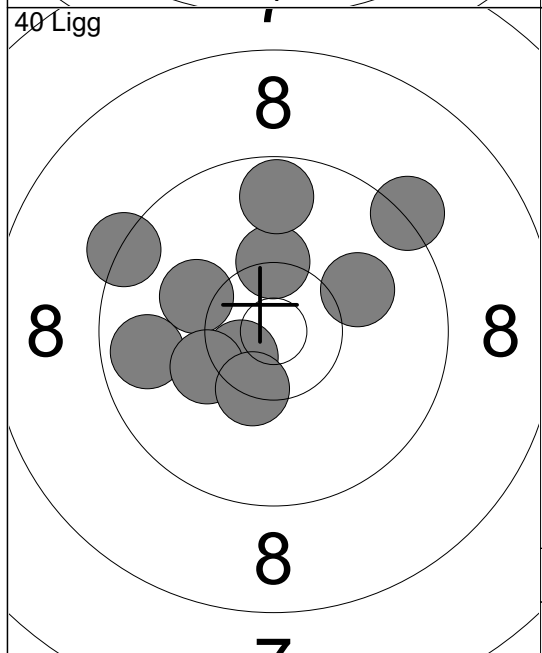

| | | |
|-------|------|-------|
| 1: | 10.2 | ↙ |
| 2: | 9.7 | ← |
| 3: | 9.3 | ↙ |
| 4: | 10.6 | ↙ |
| 5: | 10.2 | ↙ |
| 6: | 10.1 | ↗ |
| 7: | 10.3 | ↗ |
| 8: | 9.7 | ↗ |
| 9: | 9.3 | ↗ |
| 10: | 10.4 | ↘ |
| Serie | | 96.0 |
| Total | | 457.0 |

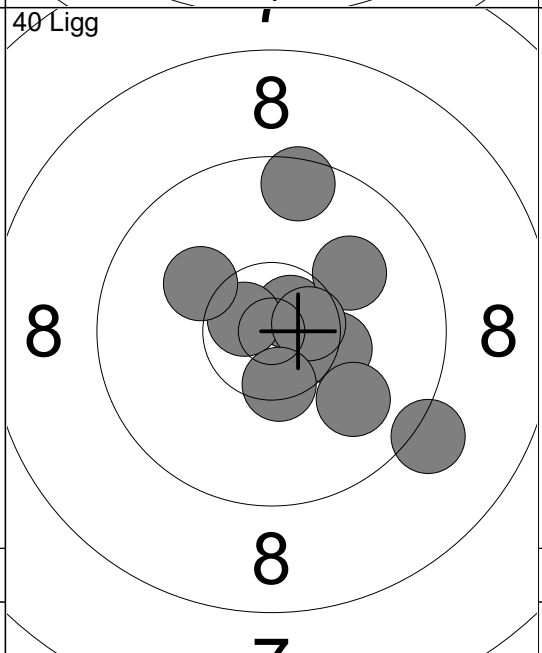

| | | |
|-------|------|-------|
| 11: | 10.7 | ↗ |
| 12: | 10.3 | → |
| 13: | 10.0 | ↗ |
| 14: | 9.5 | ↗ |
| 15: | 9.9 | ↘ |
| 16: | 10.7 | ↙ |
| 17: | 9.2 | ↘ |
| 18: | 10.6 | → |
| 19: | 10.1 | ↙ |
| 20: | 10.4 | ↘ |
| Serie | | 97.0 |
| Total | | 554.0 |

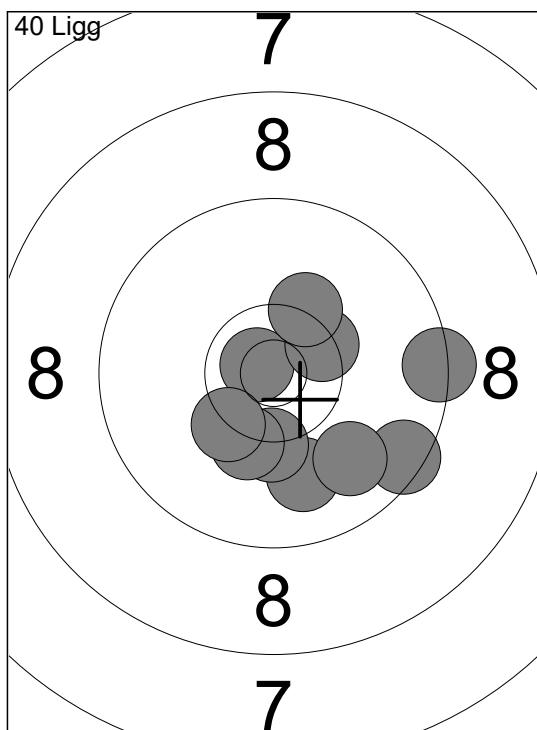

| | |
|-------|-------|
| 21: | 10.8x |
| 22: | 9.5 |
| 23: | 10.0 |
| 24: | 10.3 |
| 25: | 10.4x |
| 26: | 10.2 |
| 27: | 10.3 |
| 28: | 10.3x |
| 29: | 9.4 |
| 30: | 9.9 |
| Serie | 97.0 |
| Total | 651.0 |

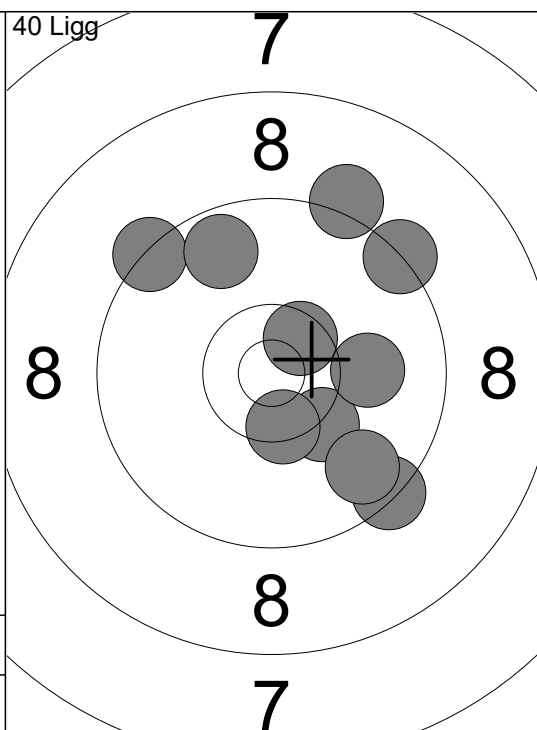

| | |
|-------|-------|
| 31: | 10.3 |
| 32: | 9.4 |
| 33: | 9.7 |
| 34: | 9.3 |
| 35: | 10.4x |
| 36: | 9.2 |
| 37: | 10.0 |
| 38: | 9.3 |
| 39: | 9.7 |
| 40: | 10.5x |
| Serie | 94.0 |
| Total | 745.0 |

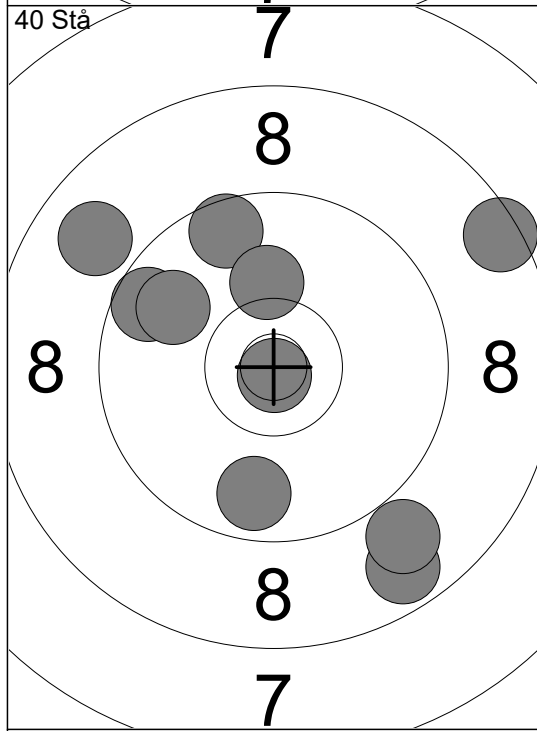

| | |
|-------|-------|
| 1: | 9.6 |
| 2: | 10.9x |
| 3: | 8.7 |
| 4: | 9.7 |
| 5: | 9.6 |
| 6: | 10.1 |
| 7: | 8.5 |
| 8: | 8.9 |
| 9: | 9.8 |
| 10: | 8.9 |
| Serie | 88.0 |
| Total | 833.0 |

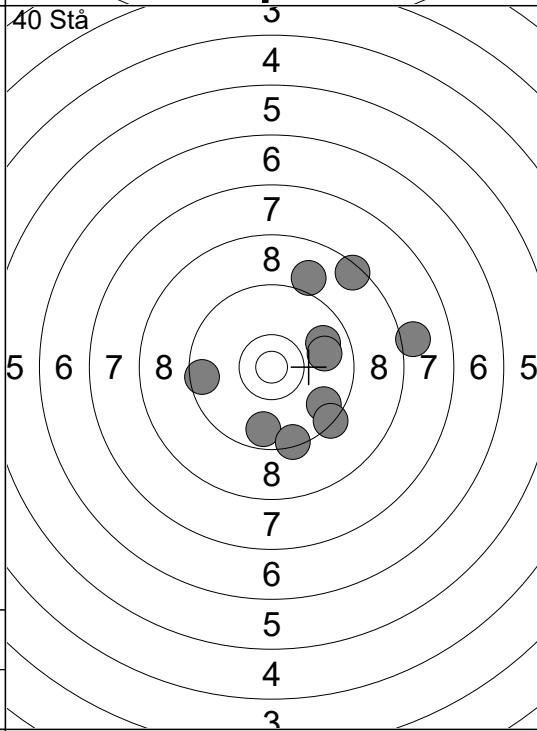

| | |
|-------|-------|
| 11: | 9.0 |
| 12: | 9.8 |
| 13: | 9.7 |
| 14: | 9.4 |
| 15: | 8.1 |
| 16: | 8.5 |
| 17: | 9.7 |
| 18: | 9.4 |
| 19: | 9.5 |
| 20: | 9.8 |
| Serie | 88.0 |
| Total | 921.0 |

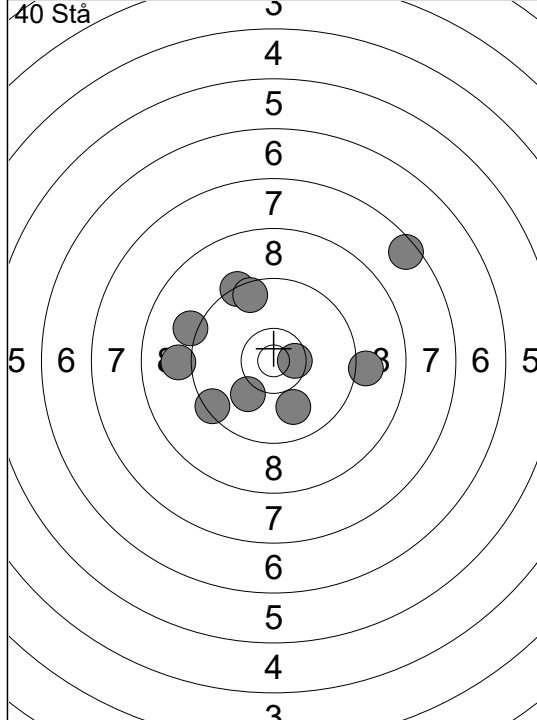

| | |
|-------|--------|
| 21: | 9.0 |
| 22: | 9.2 |
| 23: | 10.5x |
| 24: | 9.9 |
| 25: | 9.3 |
| 26: | 9.4 |
| 27: | 9.6 |
| 28: | 9.1 |
| 29: | 7.5 |
| 30: | 10.1 |
| Serie | 90.0 |
| Total | 1011.0 |

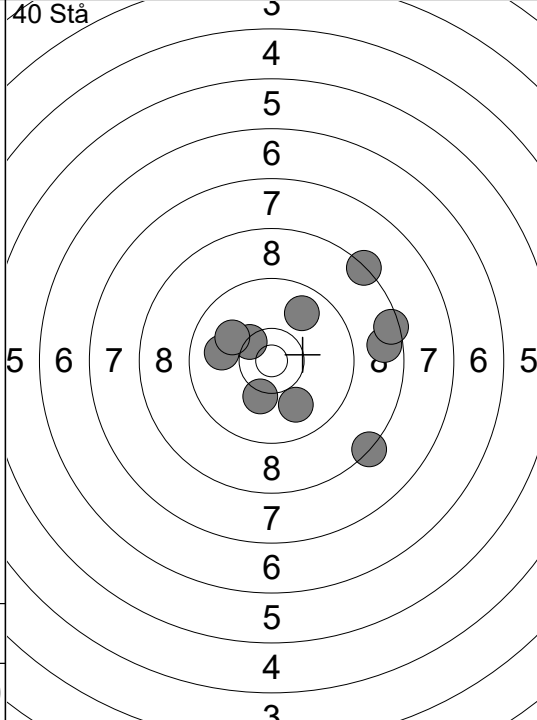

| | |
|-------|--------|
| 31: | 8.3 |
| 32: | 8.3 |
| 33: | 9.8 |
| 34: | 8.7 |
| 35: | 10.2 |
| 36: | 10.4x |
| 37: | 9.9 |
| 38: | 8.5 |
| 39: | 9.9 |
| 40: | 10.0 |
| Serie | 89.0 |
| Total | 1100.0 |

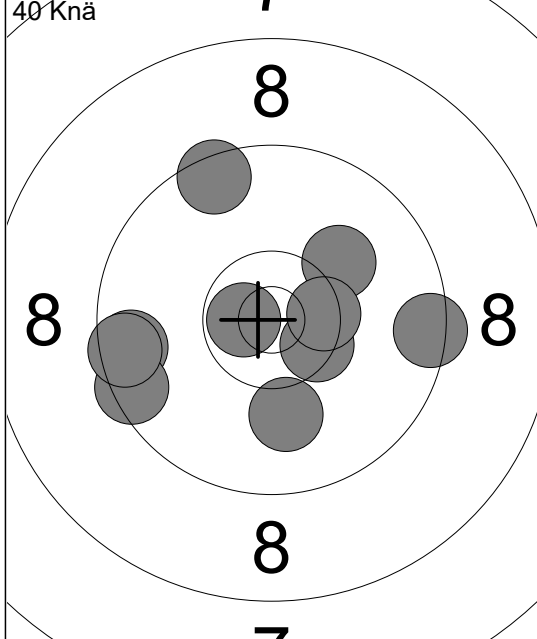

| | |
|------------|--------|
| 1: | 10.1 ↗ |
| 2: | 10.0 ↓ |
| 3: | 9.4 → |
| 4: | 9.6 ← |
| 5: | 10.5x↘ |
| 6: | 9.5 ↗ |
| 7: | 9.5 ← |
| 8: | 10.5x→ |
| 9: | 9.5 ← |
| 10: | 10.7x↖ |
| Serie 95.0 | |
| Total 95.0 | |

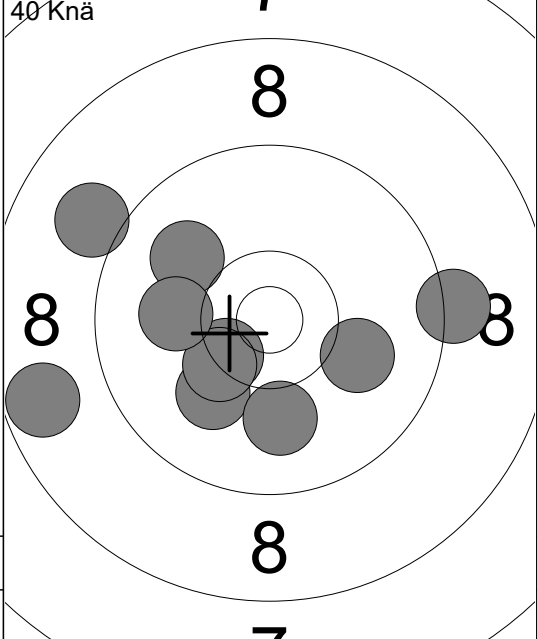

| | |
|-------------|--------|
| 11: | 10.4x↘ |
| 12: | 8.7 ← |
| 13: | 10.1 ↘ |
| 14: | 10.1 → |
| 15: | 10.0 ↖ |
| 16: | 10.0 ↓ |
| 17: | 10.3x↘ |
| 18: | 10.1 ← |
| 19: | 9.2 → |
| 20: | 9.0 ↖ |
| Serie 96.0 | |
| Total 191.0 | |

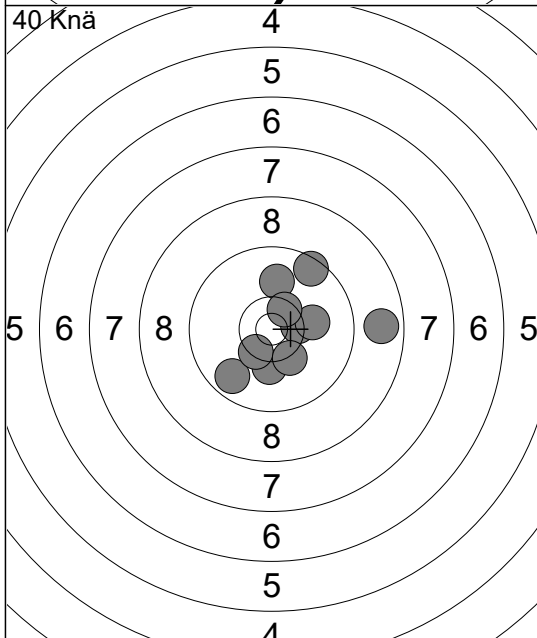

| | |
|-------------|--------|
| 21: | 10.0 ↑ |
| 22: | 9.5 ↗ |
| 23: | 9.7 ↘ |
| 24: | 10.4x→ |
| 25: | 8.8 → |
| 26: | 10.1 → |
| 27: | 10.2 ↓ |
| 28: | 10.4x↘ |
| 29: | 10.3 ↘ |
| 30: | 10.5x↗ |
| Serie 96.0 | |
| Total 287.0 | |

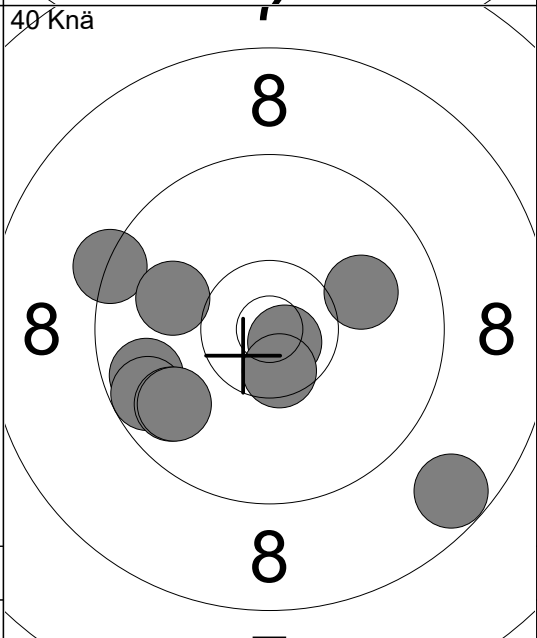

| | |
|-------------|--------|
| 31: | 10.8x↘ |
| 32: | 9.3 ← |
| 33: | 9.7 ← |
| 34: | 8.7 ↘ |
| 35: | 10.5x↘ |
| 36: | 9.7 ← |
| 37: | 10.0 ↖ |
| 38: | 9.8 ↖ |
| 39: | 10.0 → |
| 40: | 9.8 ↖ |
| Serie 93.0 | |
| Total 380.0 | |

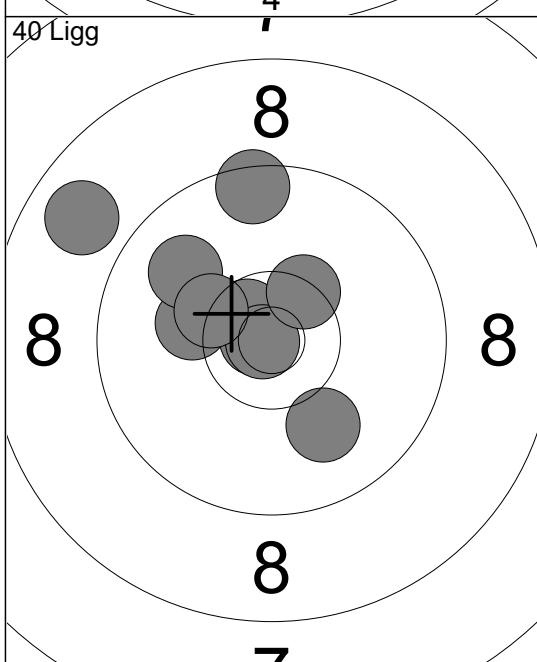

| | |
|-------------|--------|
| 1: | 10.2 ← |
| 2: | 10.8x↖ |
| 3: | 10.6x↖ |
| 4: | 10.9x↖ |
| 5: | 9.9 ↖ |
| 6: | 10.4x↗ |
| 7: | 9.5 ↑ |
| 8: | 8.8 ↖ |
| 9: | 10.3x↖ |
| 10: | 10.0 ↓ |
| Serie 96.0 | |
| Total 476.0 | |

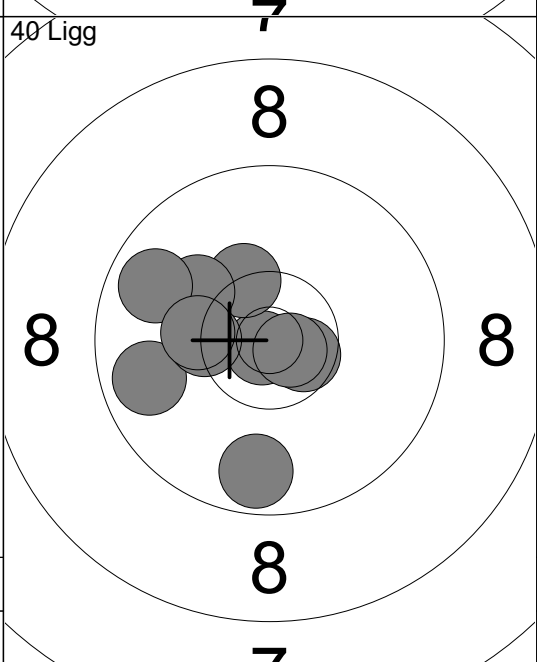

| | |
|-------------|--------|
| 11: | 9.8 ← |
| 12: | 10.6x↘ |
| 13: | 9.7 ↓ |
| 14: | 10.9x↘ |
| 15: | 10.3x↗ |
| 16: | 10.1 ↖ |
| 17: | 10.7x↘ |
| 18: | 9.8 ↖ |
| 19: | 10.3x↖ |
| 20: | 10.3 ← |
| Serie 97.0 | |
| Total 573.0 | |

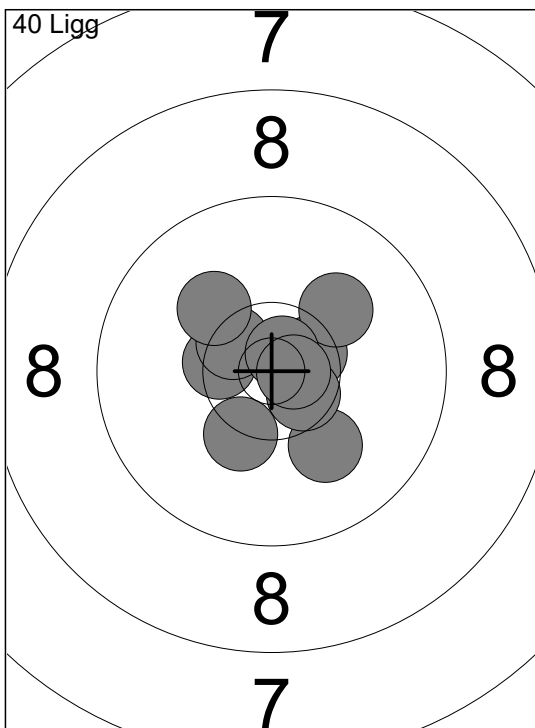

| | |
|-------|--------|
| 21: | 10.4x↖ |
| 22: | 10.1↓ |
| 23: | 10.5x↗ |
| 24: | 10.5x↖ |
| 25: | 10.6x↘ |
| 26: | 10.1↗ |
| 27: | 10.8x↗ |
| 28: | 10.7x→ |
| 29: | 10.3x↘ |
| 30: | 10.1↖ |
| Serie | 100.0 |
| Total | 673.0 |

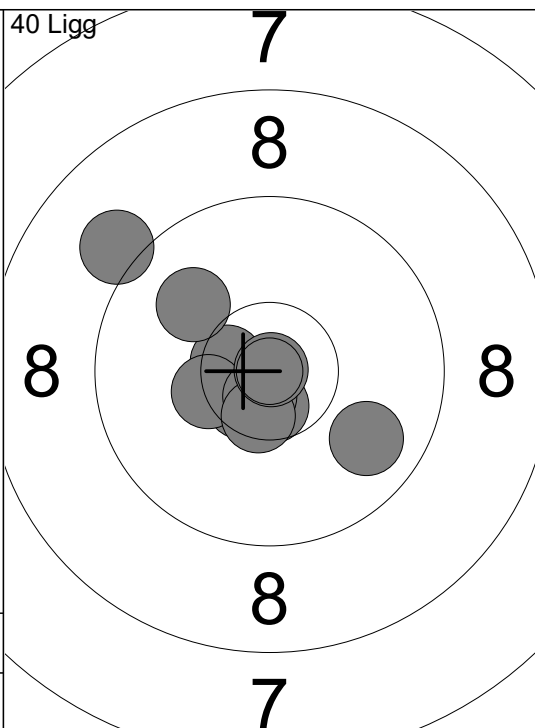

| | |
|-------|--------|
| 31: | 10.6x↘ |
| 32: | 10.5x↖ |
| 33: | 10.0↖ |
| 34: | 10.3x↖ |
| 35: | 10.6x↓ |
| 36: | 9.8↘ |
| 37: | 10.7x↘ |
| 38: | 9.1↖ |
| 39: | 10.5x↘ |
| 40: | 10.9x↗ |
| Serie | 98.0 |
| Total | 771.0 |

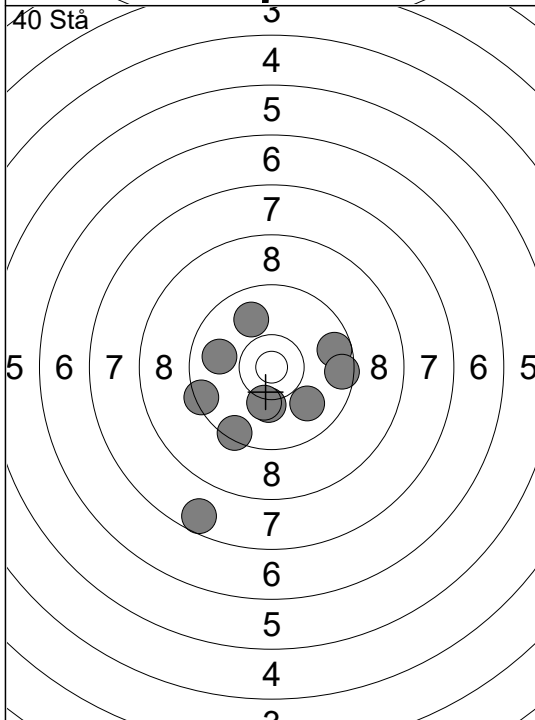

| | |
|-------|-------|
| 1: | 9.6→ |
| 2: | 10.2↓ |
| 3: | 9.4↖ |
| 4: | 9.5→ |
| 5: | 9.9↖ |
| 6: | 9.4↘ |
| 7: | 9.9↗ |
| 8: | 9.9↘ |
| 9: | 10.2↓ |
| 10: | 7.6↓ |
| Serie | 90.0 |
| Total | 861.0 |

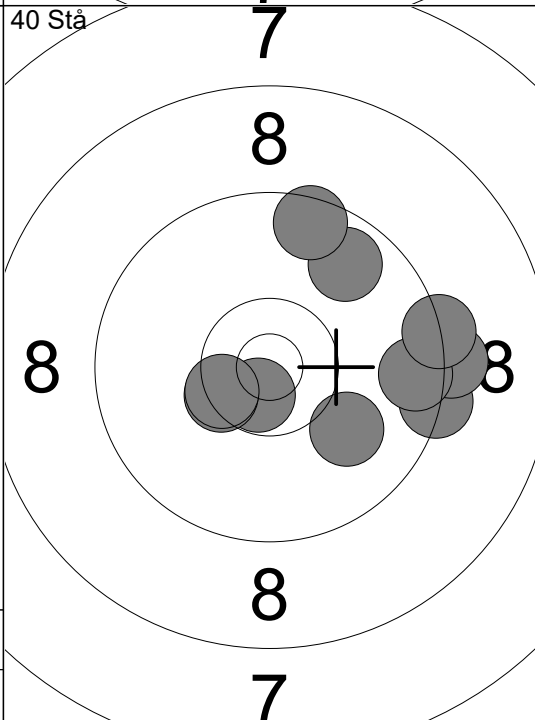

| | |
|-------|--------|
| 11: | 10.7x↘ |
| 12: | 10.4x↖ |
| 13: | 9.3→ |
| 14: | 9.7↗ |
| 15: | 9.2→ |
| 16: | 10.4x↖ |
| 17: | 10.0↘ |
| 18: | 9.5↗ |
| 19: | 9.6→ |
| 20: | 9.3→ |
| Serie | 94.0 |
| Total | 955.0 |

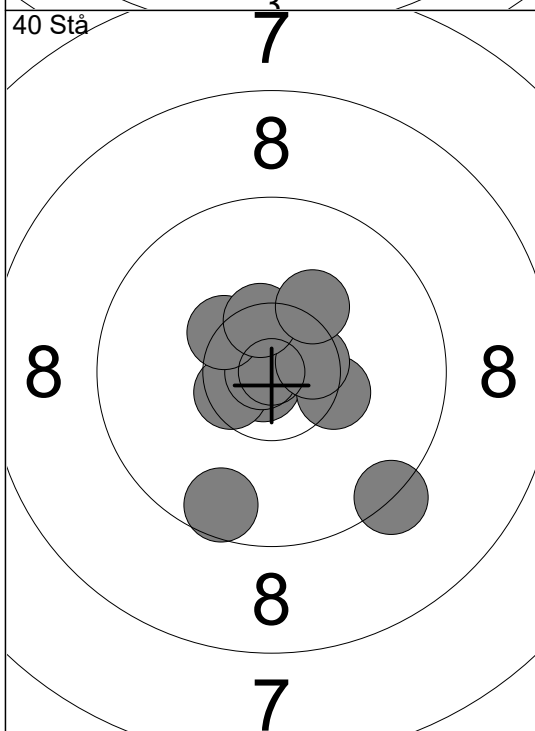

| | |
|-------|--------|
| 21: | 10.8x↘ |
| 22: | 10.5x↖ |
| 23: | 10.9x↖ |
| 24: | 10.4x↖ |
| 25: | 10.3x→ |
| 26: | 9.3↘ |
| 27: | 10.6x→ |
| 28: | 9.6↓ |
| 29: | 10.5x↗ |
| 30: | 10.2↗ |
| Serie | 98.0 |
| Total | 1053.0 |

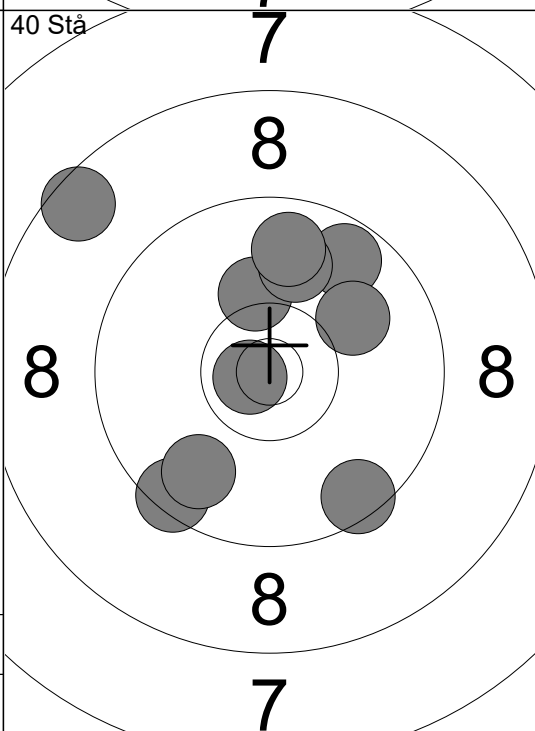

| | |
|-------|--------|
| 31: | 9.7↗ |
| 32: | 8.5↖ |
| 33: | 9.5↘ |
| 34: | 10.2↗ |
| 35: | 10.8x↖ |
| 36: | 9.8↘ |
| 37: | 9.5↘ |
| 38: | 9.9↗ |
| 39: | 10.0↗ |
| 40: | 9.8↗ |
| Serie | 92.0 |
| Total | 1145.0 |

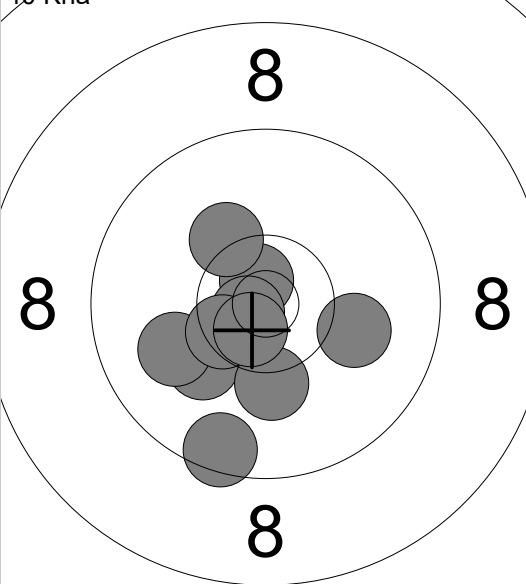
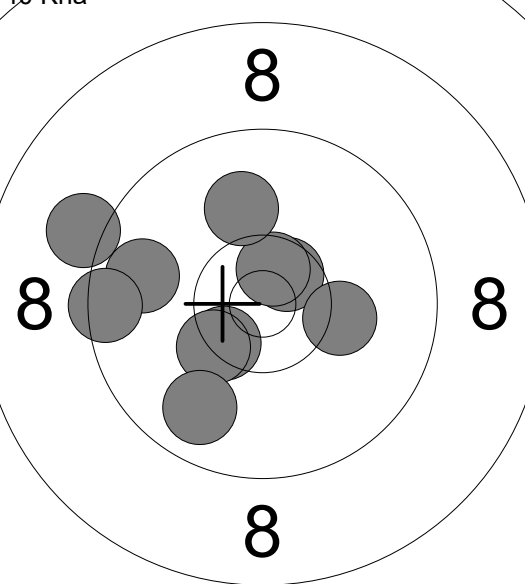
| | | | |
|--|---|--|--|
| <p>40 Knä</p>  <p style="text-align: center; font-size: 2em;">88</p> | <p>1: 10.7x ↗</p> <p>2: 10.1 ↙</p> <p>3: 10.0 ↙</p> <p>4: 9.5 ↓</p> <p>5: 10.8x ↘</p> <p>6: 10.2 ↗</p> <p>7: 10.5x ↘</p> <p>8: 10.1 →</p> <p>9: 10.2 ↓</p> <p>10: 10.7x ↘</p> <hr/> <p>Serie 99.0</p> <p>Total 99.0</p> | <p>40 Knä</p>  <p style="text-align: center; font-size: 2em;">88</p> | <p>11: 9.8 ←</p> <p>12: 10.4x ↘</p> <p>13: 9.1 ←</p> <p>14: 10.3x ↘</p> <p>15: 9.5 ←</p> <p>16: 10.6x ↗</p> <p>17: 10.6x ↗</p> <p>18: 10.2 →</p> <p>19: 10.0 ↑</p> <p>20: 9.8 ↓</p> <hr/> <p>Serie 96.0</p> <p>Total 195.0</p> |
|--|---|--|--|

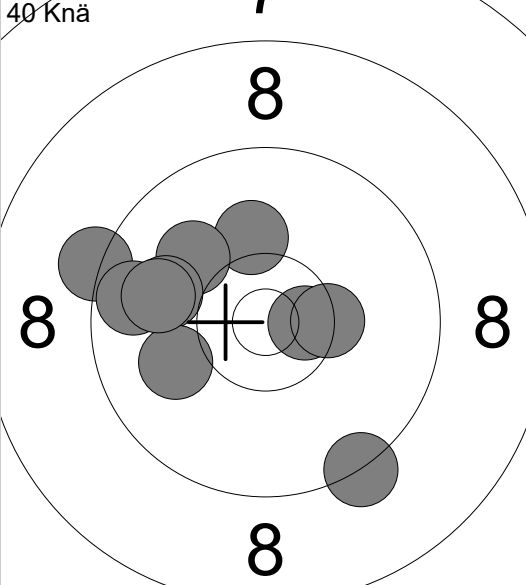
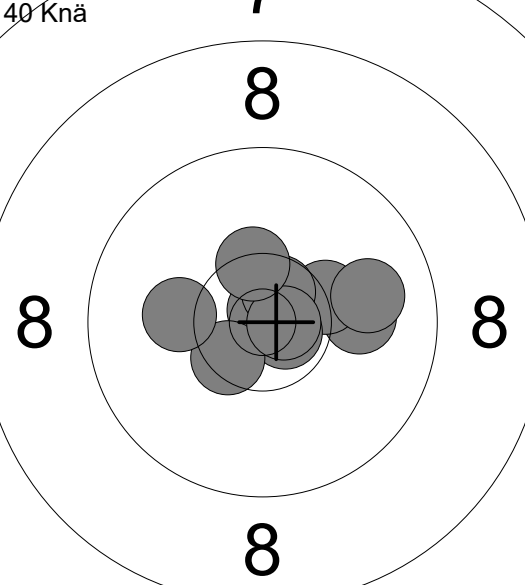
| | | | |
|---|--|---|--|
| <p>40 Knä</p>  <p style="text-align: center; font-size: 2em;">87</p> | <p>21: 10.1 ↑</p> <p>22: 9.3 ↓</p> <p>23: 10.0 ↖</p> <p>24: 9.3 ←</p> <p>25: 10.6x →</p> <p>26: 10.4x →</p> <p>27: 9.7 ←</p> <p>28: 10.0 ↖</p> <p>29: 10.0 ↖</p> <p>30: 9.9 ←</p> <hr/> <p>Serie 96.0</p> <p>Total 291.0</p> | <p>40 Knä</p>  <p style="text-align: center; font-size: 2em;">87</p> | <p>31: 10.0 →</p> <p>32: 10.3x →</p> <p>33: 10.7x →</p> <p>34: 10.8x ↗</p> <p>35: 9.9 →</p> <p>36: 10.6x ↗</p> <p>37: 10.5x ↘</p> <p>38: 10.7x →</p> <p>39: 10.2 ←</p> <p>40: 10.4x ↗</p> <hr/> <p>Serie 99.0</p> <p>Total 390.0</p> |
|---|--|---|--|

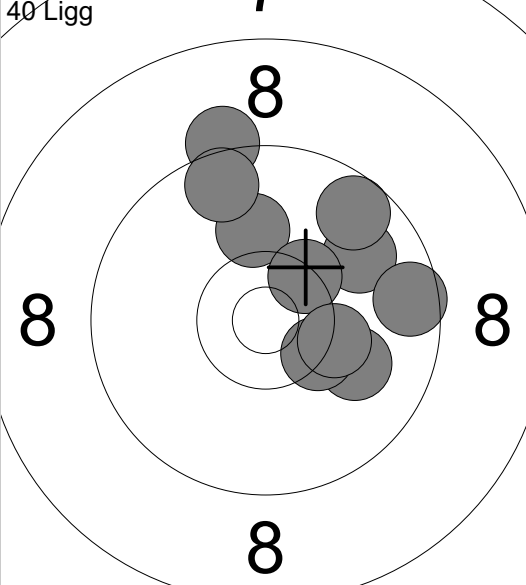
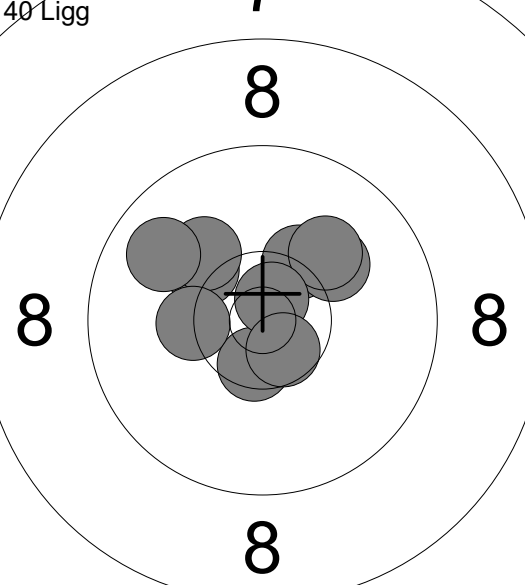
| | | | |
|---|--|---|--|
| <p>40 Ligg</p>  <p style="text-align: center; font-size: 2em;">87</p> | <p>1: 9.9 ↗</p> <p>2: 10.1 ↑</p> <p>3: 10.0 →</p> <p>4: 10.4x ↗</p> <p>5: 9.6 ↗</p> <p>6: 9.2 ↑</p> <p>7: 10.4x →</p> <p>8: 9.6 →</p> <p>9: 10.3 →</p> <p>10: 9.6 ↑</p> <hr/> <p>Serie 95.0</p> <p>Total 485.0</p> | <p>40 Ligg</p>  <p style="text-align: center; font-size: 2em;">87</p> | <p>11: 10.2 ↖</p> <p>12: 10.1 ↖</p> <p>13: 10.3x ↗</p> <p>14: 10.1 ↗</p> <p>15: 9.8 ←</p> <p>16: 10.5x ↓</p> <p>17: 10.1 ↗</p> <p>18: 10.7x ↗</p> <p>19: 10.3x ↖</p> <p>20: 10.6x ↘</p> <hr/> <p>Serie 99.0</p> <p>Total 584.0</p> |
|---|--|---|--|

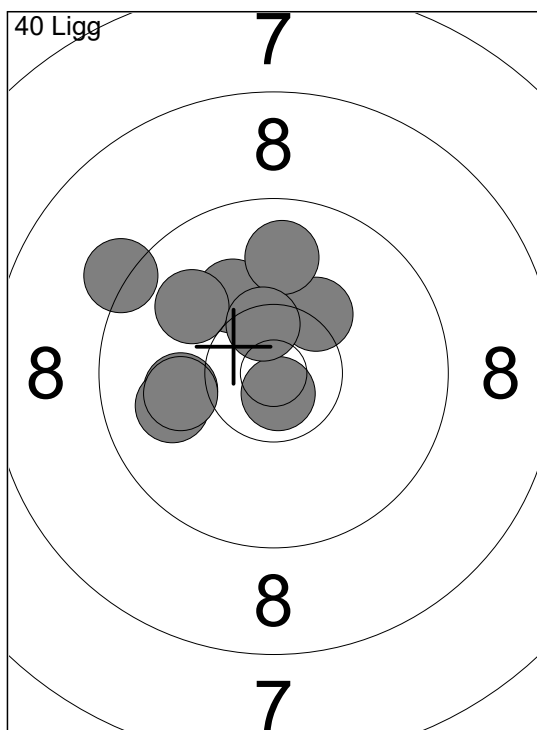

| | |
|-------|---------|
| 21: | 10.1 ↖ |
| 22: | 10.3 ↗ |
| 23: | 10.1 ← |
| 24: | 9.9 ↑ |
| 25: | 10.0 ↖ |
| 26: | 10.8x ↓ |
| 27: | 9.9 ← |
| 28: | 9.2 ↖ |
| 29: | 10.5x ↗ |
| 30: | 10.1 ← |
| Serie | 97.0 |
| Total | 681.0 |

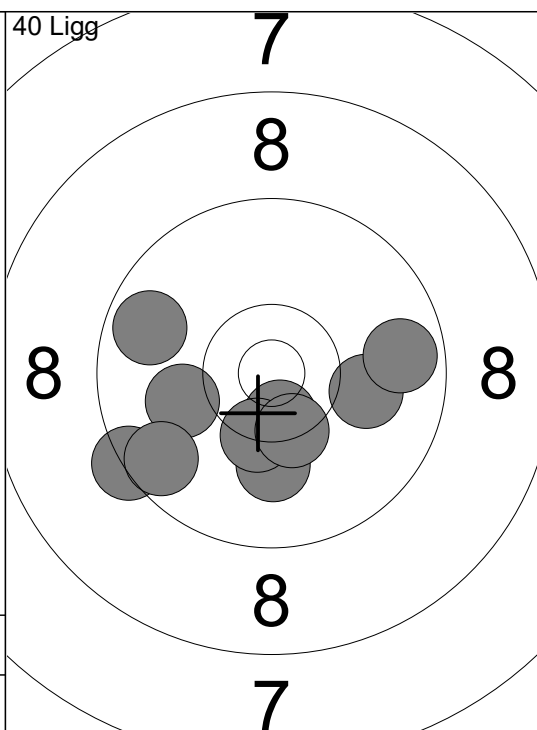

| | |
|-------|---------|
| 31: | 10.0 → |
| 32: | 10.1 ↓ |
| 33: | 9.7 → |
| 34: | 10.5x ↓ |
| 35: | 9.7 ← |
| 36: | 10.1 ← |
| 37: | 9.4 ← |
| 38: | 10.3x ↓ |
| 39: | 9.6 ← |
| 40: | 10.4x ↓ |
| Serie | 96.0 |
| Total | 777.0 |

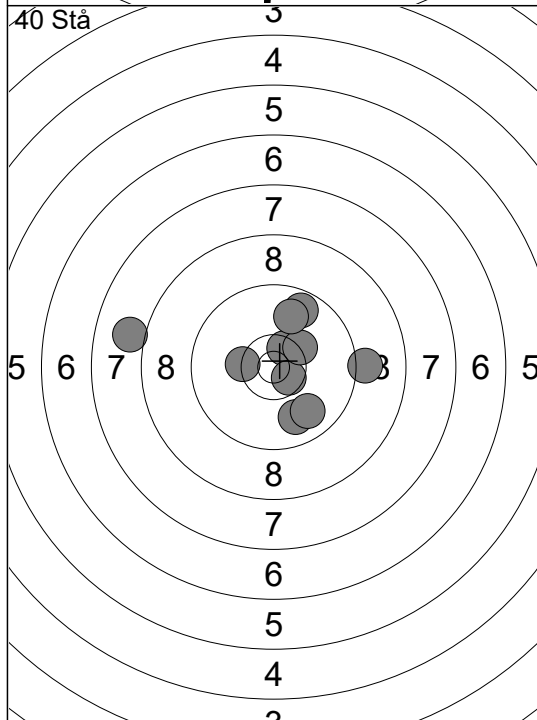

| | |
|-------|---------|
| 1: | 9.1 → |
| 2: | 9.9 ↓ |
| 3: | 10.5x ↗ |
| 4: | 10.6x ↘ |
| 5: | 10.3x ↗ |
| 6: | 8.0 ← |
| 7: | 9.8 ↓ |
| 8: | 9.7 ↑ |
| 9: | 9.9 ↑ |
| 10: | 10.3x ← |
| Serie | 93.0 |
| Total | 870.0 |

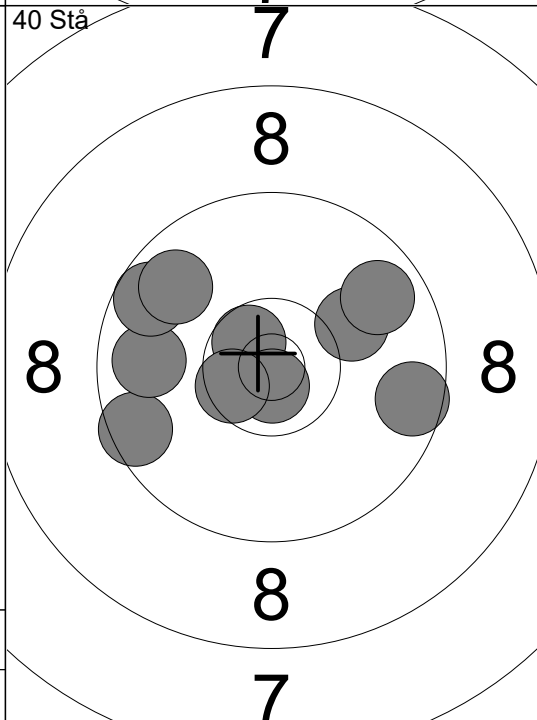

| | |
|-------|---------|
| 11: | 10.6x ↖ |
| 12: | 10.8x ↓ |
| 13: | 9.5 ← |
| 14: | 9.6 → |
| 15: | 9.8 ← |
| 16: | 10.1 ↗ |
| 17: | 9.8 ↗ |
| 18: | 10.5x ↘ |
| 19: | 9.6 ← |
| 20: | 9.8 ↖ |
| Serie | 94.0 |
| Total | 964.0 |

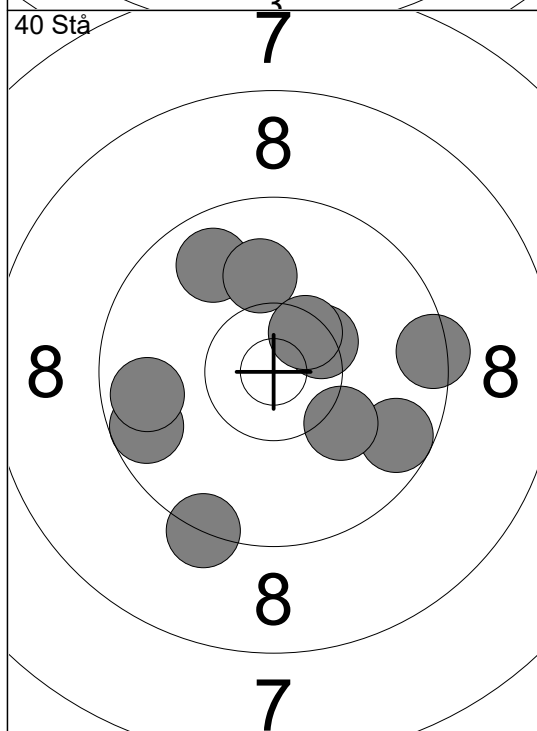

| | |
|-------|---------|
| 21: | 9.6 ← |
| 22: | 9.7 → |
| 23: | 9.4 → |
| 24: | 10.2x ↘ |
| 25: | 9.8 ↖ |
| 26: | 9.7 ← |
| 27: | 10.0 ↑ |
| 28: | 10.4x ↗ |
| 29: | 10.5x ↗ |
| 30: | 9.3 ↓ |
| Serie | 94.0 |
| Total | 1058.0 |

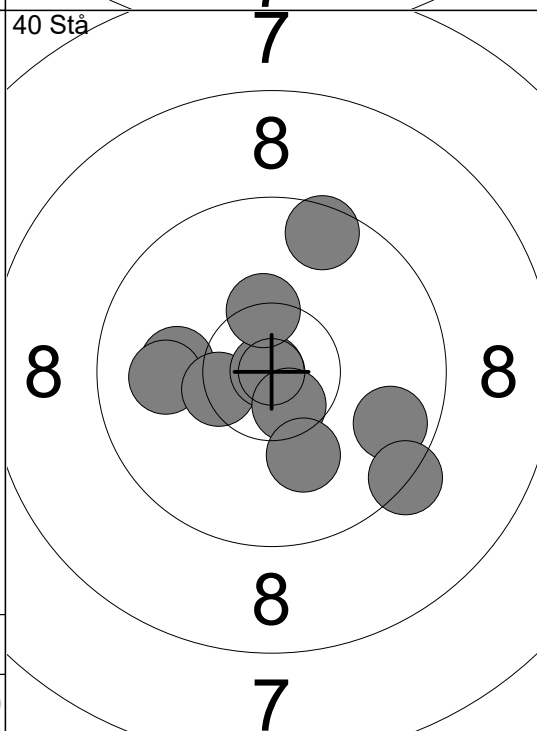

| | |
|-------|---------|
| 31: | 9.7 → |
| 32: | 9.6 ↑ |
| 33: | 10.1 ← |
| 34: | 10.0 ← |
| 35: | 9.3 ↓ |
| 36: | 10.4x ↘ |
| 37: | 10.9x ↘ |
| 38: | 10.6x ↘ |
| 39: | 10.1 ↓ |
| 40: | 10.4x ↗ |
| Serie | 97.0 |
| Total | 1155.0 |

| | | | |
|---------------|---|---------------|--|
| <p>40 Knä</p> | <p>1: 10.3x↙ 2: 10.5x↘ 3: 10.0 ↘ 4: 8.9 ↘ 5: 9.8 → 6: 9.9 ↘ 7: 9.9 ↓ 8: 10.6x↘ 9: 9.6 ↗ 10: 10.7x→</p> <p>Serie 94.0 Total 94.0</p> | <p>40 Knä</p> | <p>11: 10.8x↘ 12: 9.7 ↖ 13: 10.0 → 14: 10.2↙ 15: 10.1 ↘ 16: 10.6x↘ 17: 9.8 ↓ 18: 10.2↙ 19: 10.8x↘ 20: 10.6x↗</p> <p>Serie 98.0 Total 192.0</p> |
|---------------|---|---------------|--|

| | | | |
|---------------|--|---------------|---|
| <p>40 Knä</p> | <p>21: 10.6x↘ 22: 10.7x↘ 23: 9.2 ↓ 24: 10.4x↘ 25: 10.2↙ 26: 10.9x↗ 27: 10.2↖ 28: 10.0 → 29: 9.6 ↘ 30: 10.4x↘</p> <p>Serie 98.0 Total 290.0</p> | <p>40 Knä</p> | <p>31: 9.4 ← 32: 10.5x↘ 33: 9.9 ↗ 34: 9.9 ↖ 35: 9.4 ↙ 36: 9.5 ↓ 37: 10.5x↘ 38: 9.8 ↘ 39: 10.8x↘ 40: 9.9 ↖</p> <p>Serie 93.0 Total 383.0</p> |
|---------------|--|---------------|---|

| | | | |
|----------------|--|----------------|--|
| <p>40 Ligg</p> | <p>1: 10.4x→ 2: 10.4x↘ 3: 10.5x→ 4: 10.1 → 5: 10.5x↘ 6: 10.6x↗ 7: 10.2 → 8: 10.0 → 9: 10.9x↘ 10: 10.8x→</p> <p>Serie 100.0 Total 483.0</p> | <p>40 Ligg</p> | <p>11: 10.6x→ 12: 10.5x↙ 13: 9.6 ← 14: 9.8 ↘ 15: 10.4x↙ 16: 9.7 → 17: 9.9 ↙ 18: 10.7x↘ 19: 10.2↙ 20: 9.2 ↙</p> <p>Serie 95.0 Total 578.0</p> |
|----------------|--|----------------|--|

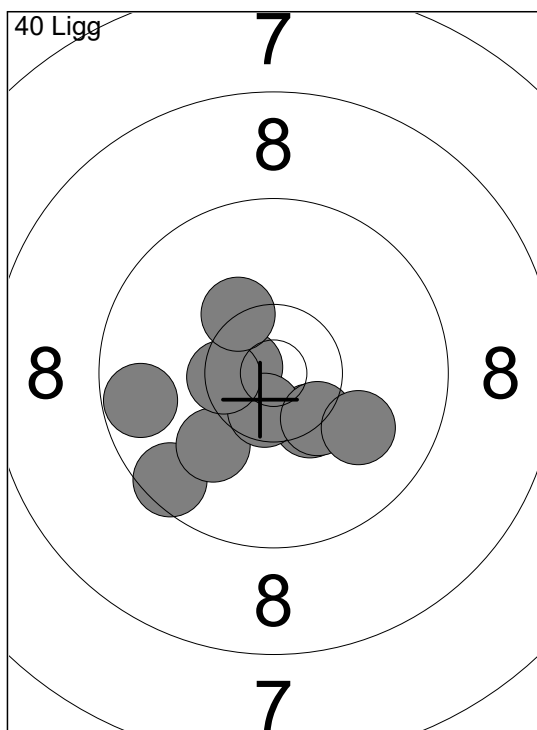

| | | |
|-------|------|-------|
| 21: | 10.7 | ↖ |
| 22: | 9.5 | ↙ |
| 23: | 9.7 | ← |
| 24: | 10.1 | ↙ |
| 25: | 10.4 | ↘ |
| 26: | 10.6 | ↘ |
| 27: | 10.4 | ↘ |
| 28: | 10.0 | ↘ |
| 29: | 10.5 | ↖ |
| 30: | 10.3 | ↖ |
| Serie | | 98.0 |
| Total | | 676.0 |

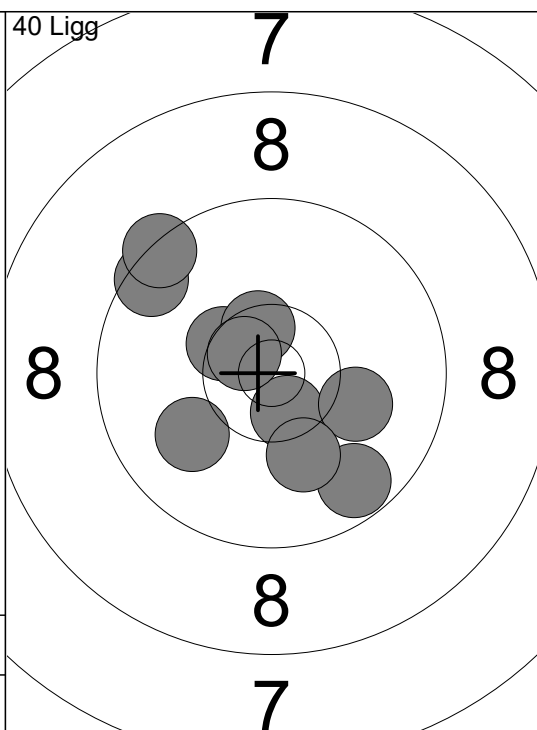

| | | |
|-------|------|-------|
| 31: | 9.5 | ↖ |
| 32: | 10.4 | ↖ |
| 33: | 9.4 | ↖ |
| 34: | 10.0 | ↙ |
| 35: | 9.7 | ↘ |
| 36: | 10.5 | ↘ |
| 37: | 10.1 | → |
| 38: | 10.5 | ↗ |
| 39: | 10.1 | ↘ |
| 40: | 10.6 | ↖ |
| Serie | | 97.0 |
| Total | | 773.0 |

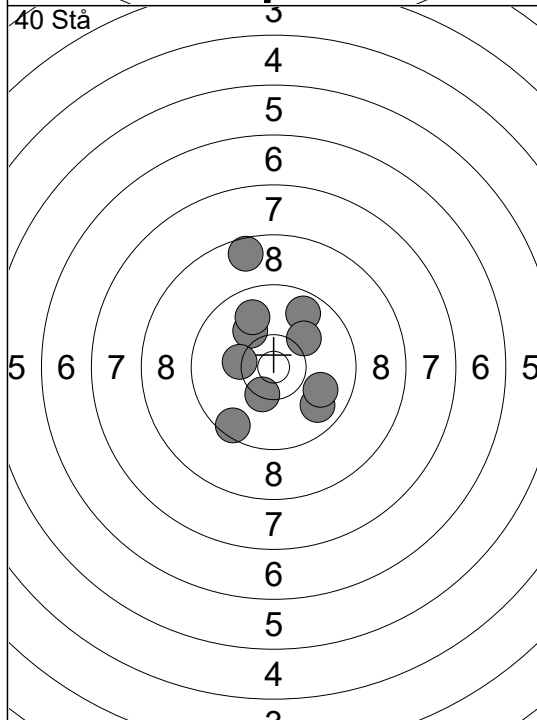

| | | |
|-------|------|-------|
| 1: | 8.6 | ↑ |
| 2: | 9.5 | ↙ |
| 3: | 10.4 | ↘ |
| 4: | 10.1 | ↖ |
| 5: | 9.9 | ↑ |
| 6: | 9.8 | ↘ |
| 7: | 10.3 | ↖ |
| 8: | 9.7 | ↑ |
| 9: | 9.9 | → |
| 10: | 10.1 | ↗ |
| Serie | | 93.0 |
| Total | | 866.0 |

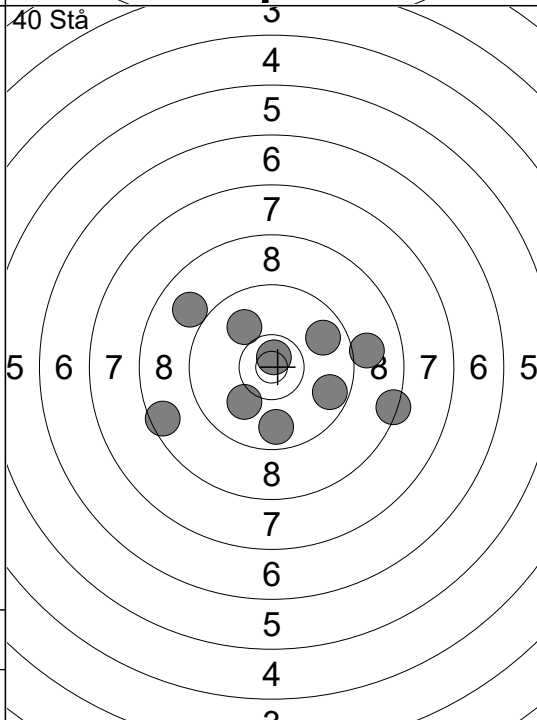

| | | |
|-------|------|-------|
| 11: | 9.8 | ↗ |
| 12: | 9.0 | → |
| 13: | 8.5 | ↖ |
| 14: | 8.4 | → |
| 15: | 8.9 | ↖ |
| 16: | 10.0 | ↖ |
| 17: | 10.1 | ↘ |
| 18: | 9.7 | → |
| 19: | 10.7 | ↗ |
| 20: | 9.7 | ↓ |
| Serie | | 90.0 |
| Total | | 956.0 |

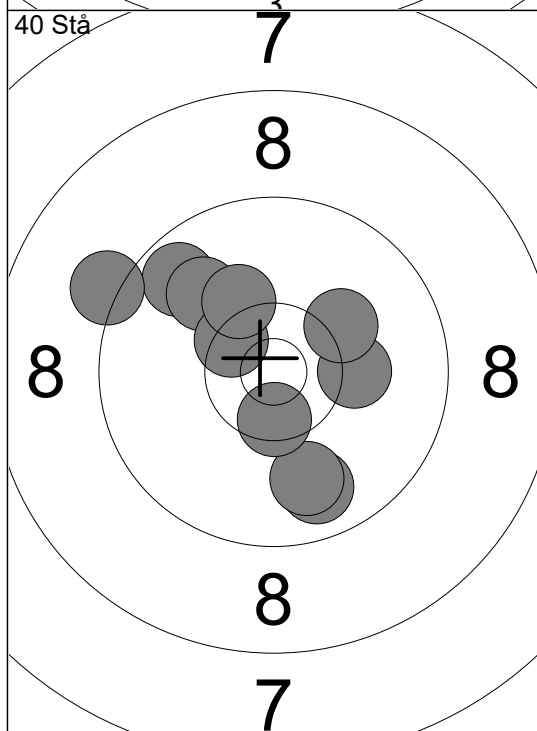

| | | |
|-------|------|--------|
| 21: | 9.7 | ↖ |
| 22: | 10.0 | ↖ |
| 23: | 9.8 | ↘ |
| 24: | 10.2 | → |
| 25: | 10.2 | ↗ |
| 26: | 10.5 | ↖ |
| 27: | 9.9 | ↘ |
| 28: | 10.5 | ↘ |
| 29: | 10.2 | ↖ |
| 30: | 9.2 | ↖ |
| Serie | | 96.0 |
| Total | | 1052.0 |

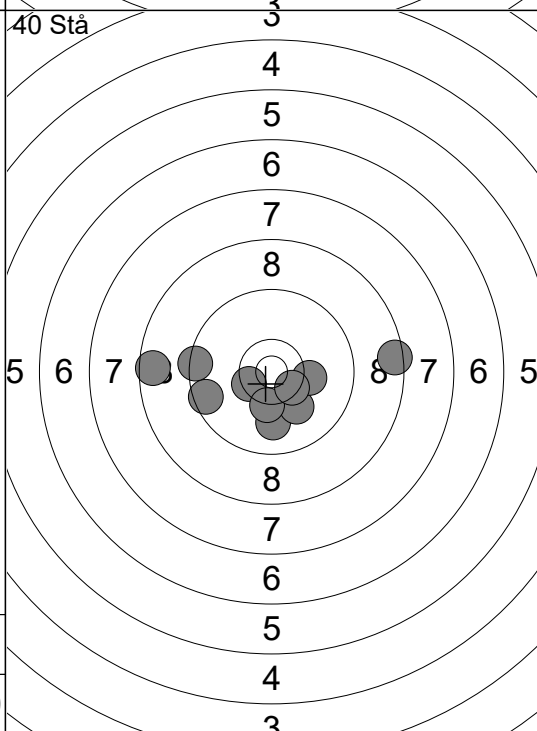

| | | |
|-------|------|--------|
| 31: | 9.9 | ↓ |
| 32: | 10.1 | ↘ |
| 33: | 8.5 | → |
| 34: | 10.4 | ↖ |
| 35: | 10.3 | ↘ |
| 36: | 8.6 | ← |
| 37: | 9.5 | ↖ |
| 38: | 10.2 | → |
| 39: | 9.4 | ← |
| 40: | 10.4 | ↘ |
| Serie | | 93.0 |
| Total | | 1145.0 |

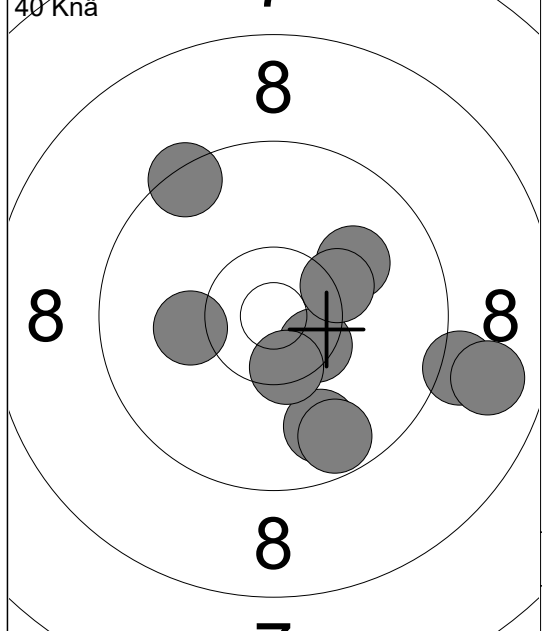

| | |
|------------|--------|
| 1: | 10.5x↘ |
| 2: | 9.8 ↓ |
| 3: | 9.1 → |
| 4: | 10.4x↓ |
| 5: | 9.7 ↓ |
| 6: | 9.4 ↗ |
| 7: | 10.2← |
| 8: | 10.0↗ |
| 9: | 8.8 → |
| 10: | 10.3↗ |
| Serie 94.0 | |
| Total 94.0 | |

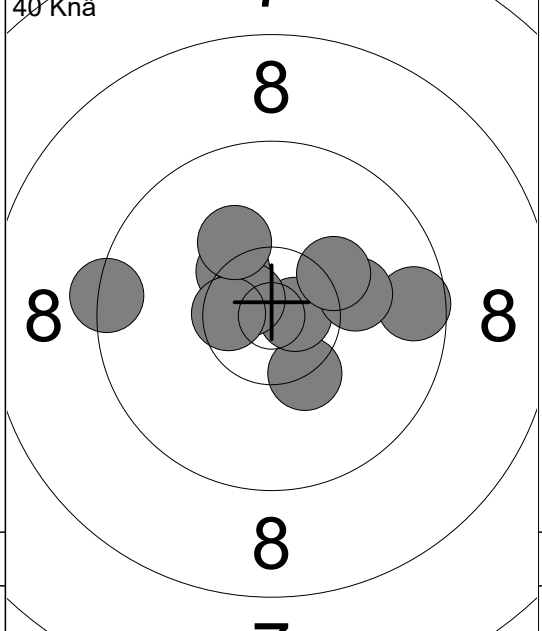

| | |
|-------------|--------|
| 11: | 9.4 ← |
| 12: | 10.3x↓ |
| 13: | 10.7x→ |
| 14: | 10.4x↘ |
| 15: | 10.7x↘ |
| 16: | 10.5x← |
| 17: | 9.6 → |
| 18: | 10.1↗ |
| 19: | 10.2↗ |
| 20: | 10.2↗ |
| Serie 98.0 | |
| Total 192.0 | |

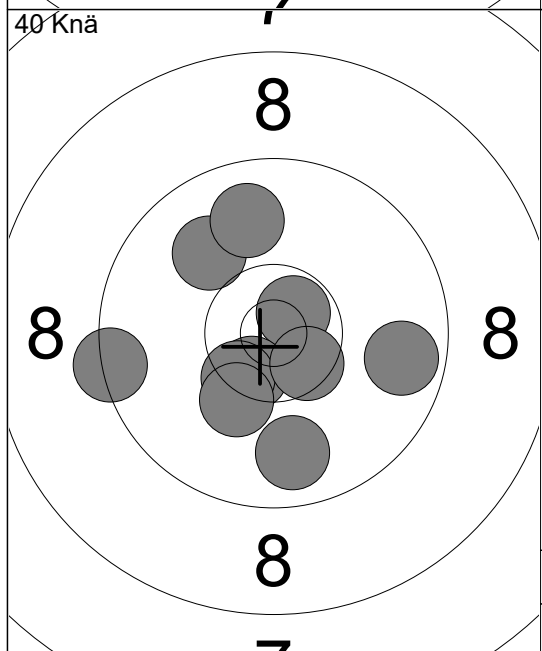

| | |
|-------------|--------|
| 21: | 10.0 ↖ |
| 22: | 9.8 ↓ |
| 23: | 9.7 → |
| 24: | 10.7x↗ |
| 25: | 9.9 ↗ |
| 26: | 9.4 ← |
| 27: | 10.5x↓ |
| 28: | 10.4x↓ |
| 29: | 10.2 ↓ |
| 30: | 10.5x↘ |
| Serie 96.0 | |
| Total 288.0 | |

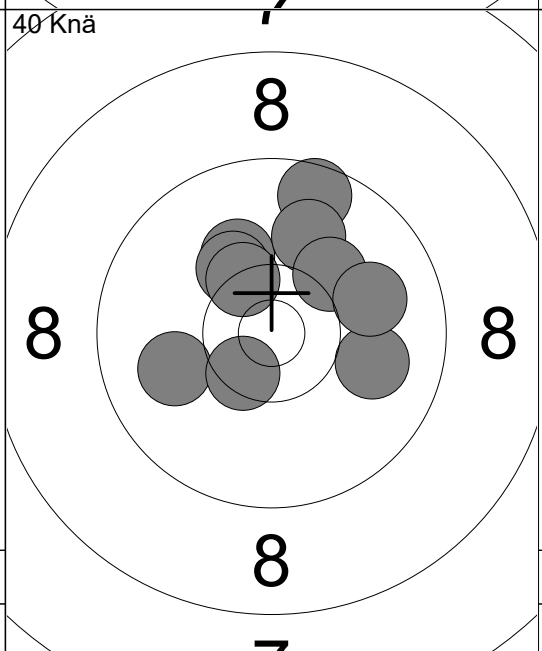

| | |
|-------------|--------|
| 31: | 9.6 ↗ |
| 32: | 10.2 ↖ |
| 33: | 10.0 ↗ |
| 34: | 10.2 ↗ |
| 35: | 10.0← |
| 36: | 10.0→ |
| 37: | 10.2 ↖ |
| 38: | 10.5x↓ |
| 39: | 10.4x↘ |
| 40: | 10.0→ |
| Serie 99.0 | |
| Total 387.0 | |

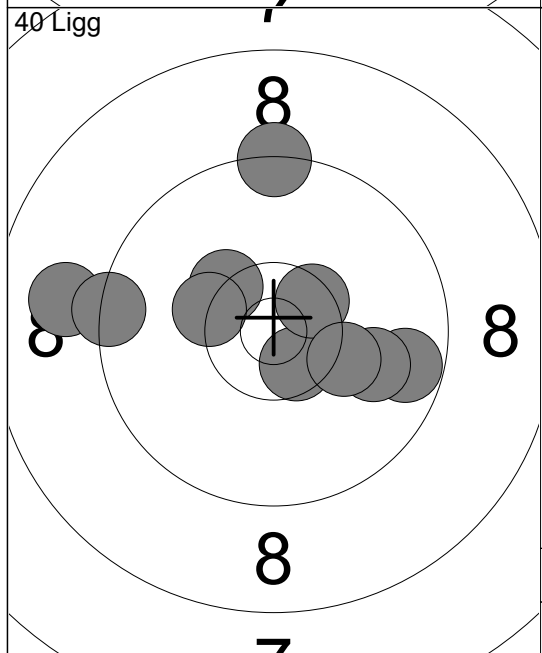

| | |
|-------------|--------|
| 1: | 9.7 → |
| 2: | 9.3 ↗ |
| 3: | 10.0→ |
| 4: | 10.3x↘ |
| 5: | 10.6x↓ |
| 6: | 10.5x↗ |
| 7: | 9.0 ← |
| 8: | 10.3x↘ |
| 9: | 10.2→ |
| 10: | 9.4 ← |
| Serie 96.0 | |
| Total 483.0 | |

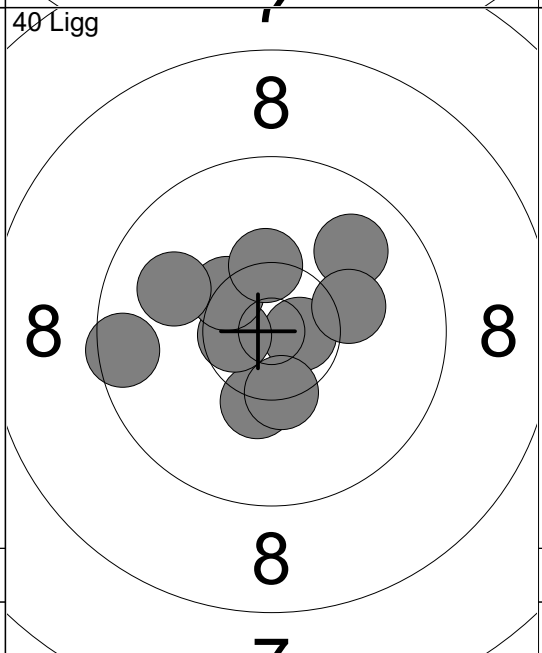

| | |
|-------------|--------|
| 11: | 10.3 ↓ |
| 12: | 10.7x→ |
| 13: | 10.6x← |
| 14: | 10.4x↓ |
| 15: | 9.9 ↗ |
| 16: | 9.5 ← |
| 17: | 10.4x↘ |
| 18: | 9.9 ← |
| 19: | 10.3x↗ |
| 20: | 10.2→ |
| Serie 97.0 | |
| Total 580.0 | |

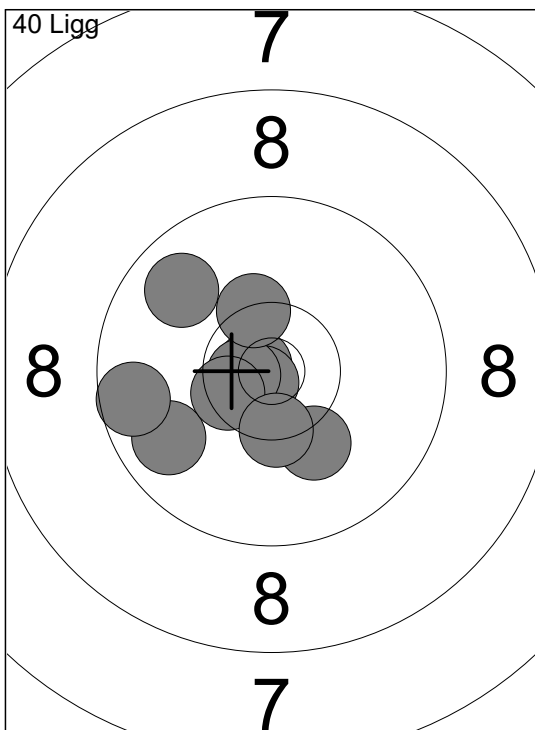

| | |
|-------|-------|
| 21: | 10.8x |
| 22: | 10.8x |
| 23: | 9.8 |
| 24: | 9.6 |
| 25: | 10.7x |
| 26: | 10.5x |
| 27: | 10.2 |
| 28: | 10.4x |
| 29: | 10.4x |
| 30: | 9.8 |
| Serie | 97.0 |
| Total | 677.0 |

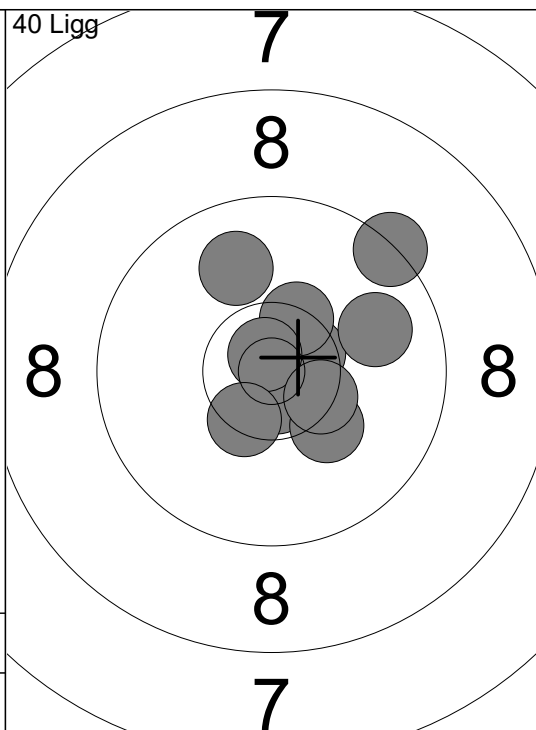

| | |
|-------|-------|
| 31: | 9.9 |
| 32: | 10.6x |
| 33: | 10.4x |
| 34: | 10.7x |
| 35: | 10.2 |
| 36: | 9.3 |
| 37: | 10.8x |
| 38: | 9.9 |
| 39: | 10.4x |
| 40: | 10.4x |
| Serie | 97.0 |
| Total | 774.0 |

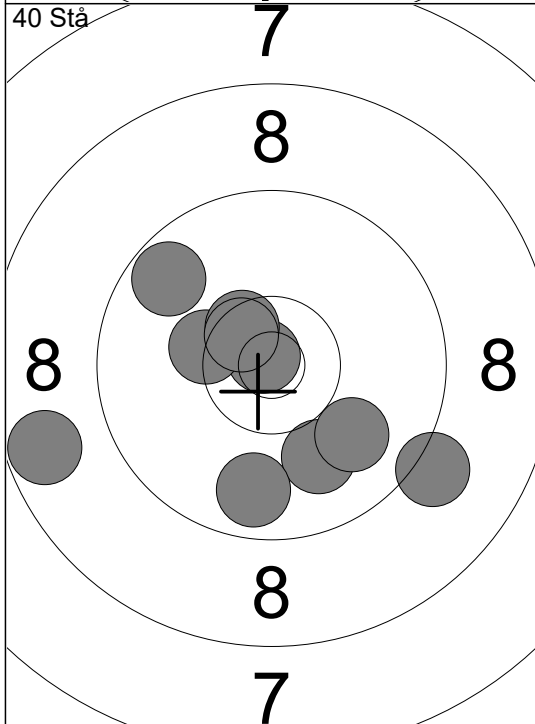

| | |
|-------|-------|
| 1: | 10.0 |
| 2: | 9.9 |
| 3: | 9.8 |
| 4: | 9.1 |
| 5: | 9.7 |
| 6: | 10.8x |
| 7: | 10.3x |
| 8: | 10.5x |
| 9: | 10.5x |
| 10: | 8.7 |
| Serie | 94.0 |
| Total | 868.0 |

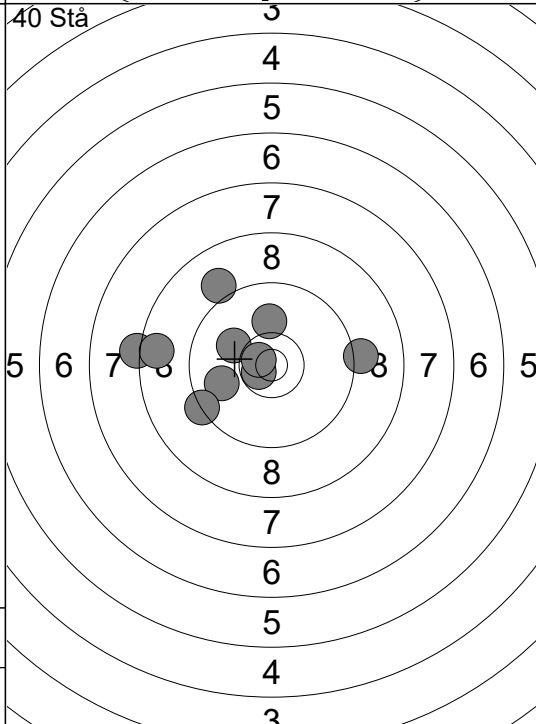

| | |
|-------|-------|
| 11: | 9.9 |
| 12: | 10.1 |
| 13: | 9.1 |
| 14: | 10.7x |
| 15: | 9.0 |
| 16: | 10.1 |
| 17: | 10.7x |
| 18: | 8.2 |
| 19: | 9.3 |
| 20: | 8.6 |
| Serie | 92.0 |
| Total | 960.0 |

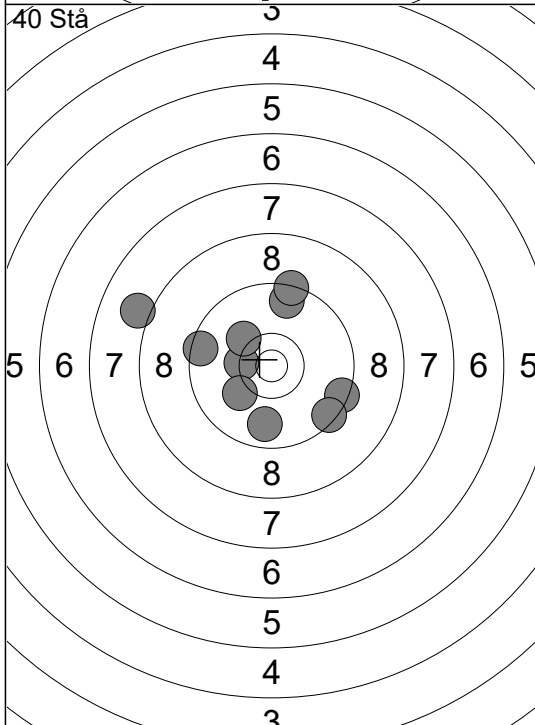

| | |
|-------|--------|
| 21: | 10.3x |
| 22: | 10.1 |
| 23: | 8.0 |
| 24: | 9.5 |
| 25: | 10.2 |
| 26: | 9.4 |
| 27: | 9.8 |
| 28: | 9.4 |
| 29: | 9.6 |
| 30: | 9.3 |
| Serie | 92.0 |
| Total | 1052.0 |

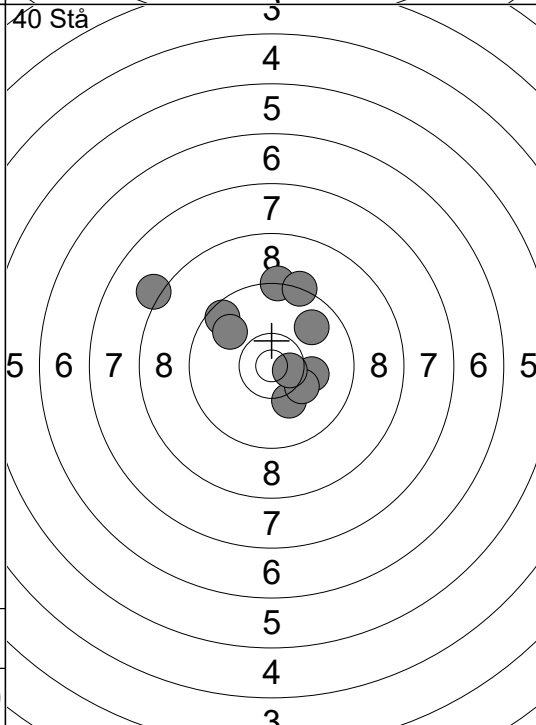

| | |
|-------|--------|
| 31: | 9.8 |
| 32: | 10.2 |
| 33: | 10.1 |
| 34: | 9.3 |
| 35: | 10.2 |
| 36: | 9.3 |
| 37: | 9.6 |
| 38: | 10.6x |
| 39: | 9.9 |
| 40: | 8.2 |
| Serie | 93.0 |
| Total | 1145.0 |

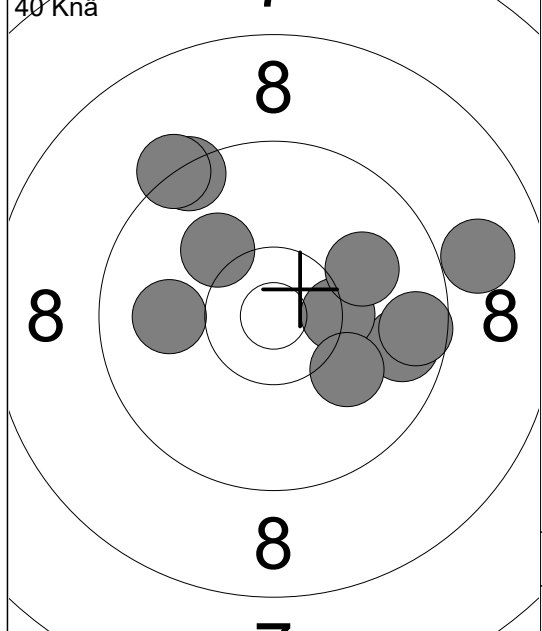

| | |
|------------|---------|
| 1: | 10.0 ← |
| 2: | 8.9 → |
| 3: | 9.7 → |
| 4: | 10.3x → |
| 5: | 10.0 → |
| 6: | 9.4 ↗ |
| 7: | 9.3 ↗ |
| 8: | 10.1 ↘ |
| 9: | 9.6 → |
| 10: | 10.1 ↖ |
| Serie 94.0 | |
| Total 94.0 | |

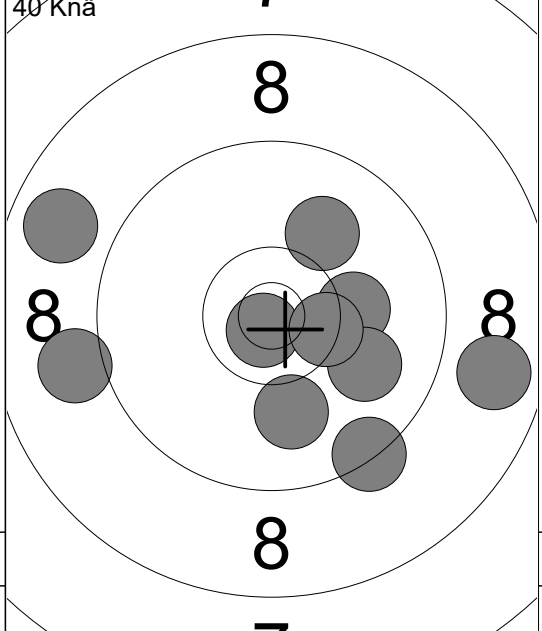

| | |
|-------------|---------|
| 11: | 8.8 ↖ |
| 12: | 10.2 → |
| 13: | 9.0 ← |
| 14: | 10.0 ↓ |
| 15: | 10.0 → |
| 16: | 10.0 ↗ |
| 17: | 8.8 → |
| 18: | 10.8x ↘ |
| 19: | 10.4x → |
| 20: | 9.4 ↘ |
| Serie 94.0 | |
| Total 188.0 | |

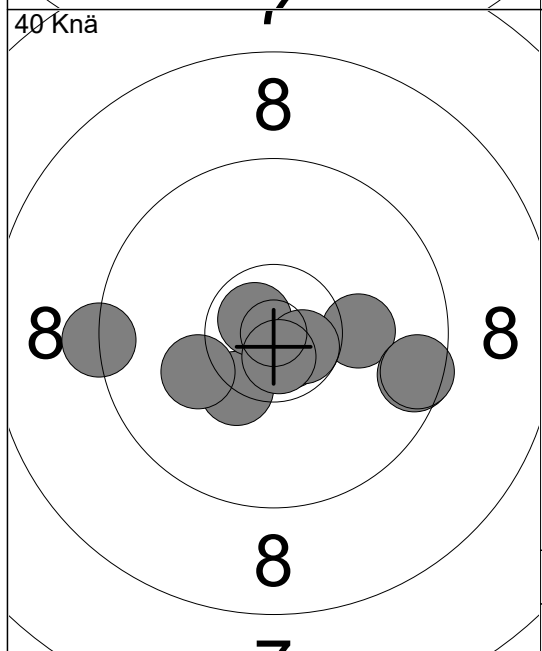

| | |
|-------------|---------|
| 21: | 10.1 → |
| 22: | 9.3 ← |
| 23: | 10.3x ↘ |
| 24: | 10.7x ↘ |
| 25: | 10.7x ↘ |
| 26: | 10.6x → |
| 27: | 10.7x ↘ |
| 28: | 9.6 → |
| 29: | 9.5 → |
| 30: | 10.1 ← |
| Serie 97.0 | |
| Total 285.0 | |

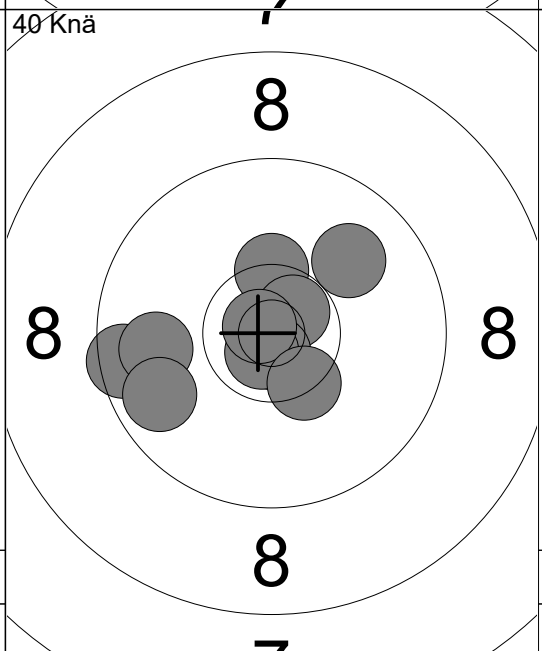

| | |
|-------------|---------|
| 31: | 10.4x ↗ |
| 32: | 9.5 ← |
| 33: | 10.7x ↗ |
| 34: | 10.0 ↗ |
| 35: | 10.8x ↘ |
| 36: | 10.7x ↘ |
| 37: | 9.8 ← |
| 38: | 9.7 ← |
| 39: | 10.8x ↘ |
| 40: | 10.4x ↘ |
| Serie 97.0 | |
| Total 382.0 | |

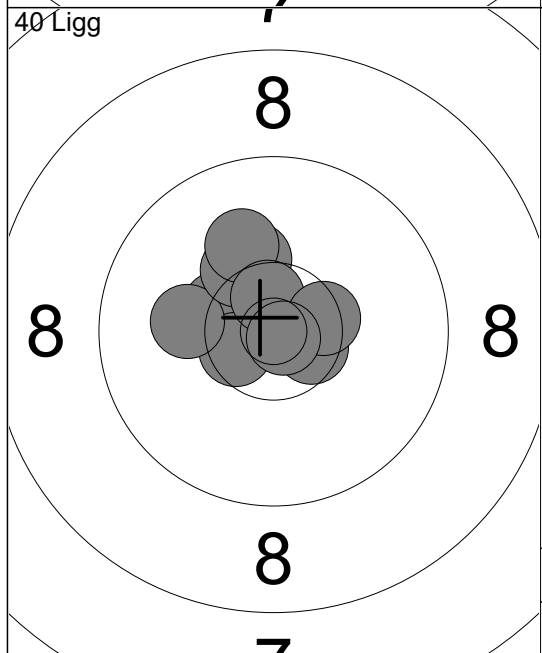

| | |
|-------------|---------|
| 1: | 10.2 ↗ |
| 2: | 10.4x ↘ |
| 3: | 10.6x ↘ |
| 4: | 10.1 ← |
| 5: | 10.3 ↗ |
| 6: | 10.6x → |
| 7: | 10.1 ↗ |
| 8: | 10.6x ↗ |
| 9: | 10.5x → |
| 10: | 10.8x ↘ |
| Serie 100.0 | |
| Total 482.0 | |

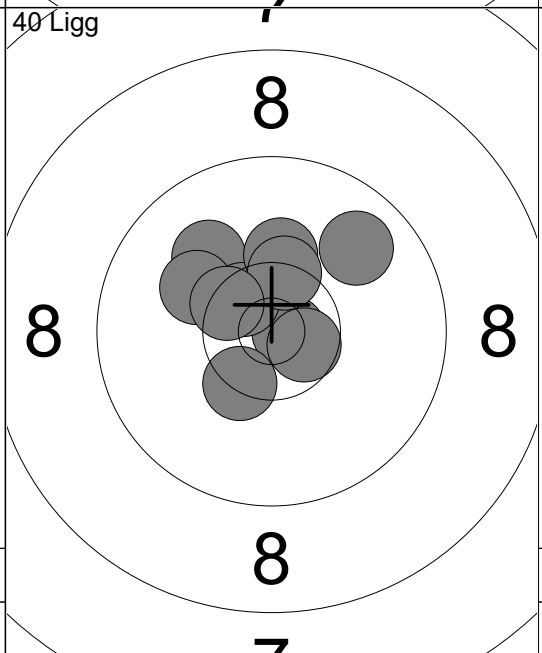

| | |
|-------------|---------|
| 11: | 10.8x → |
| 12: | 10.0 ↖ |
| 13: | 10.1 ← |
| 14: | 10.5x ↘ |
| 15: | 10.6x → |
| 16: | 10.2 ↗ |
| 17: | 10.4x ↘ |
| 18: | 9.8 ↗ |
| 19: | 10.4x ↗ |
| 20: | 10.5x ↘ |
| Serie 99.0 | |
| Total 581.0 | |

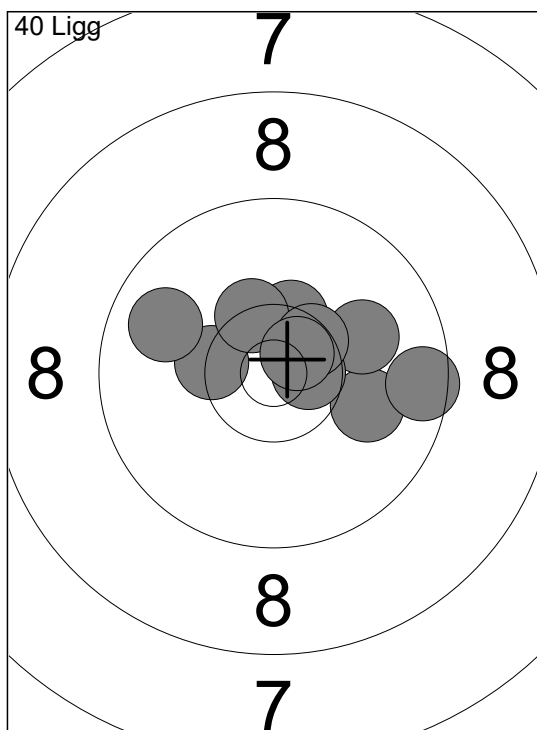

| | | |
|-------|------|-------|
| 21: | 10.0 | → |
| 22: | 10.4 | ✕ |
| 23: | 10.4 | ↗ |
| 24: | 9.8 | ← |
| 25: | 10.1 | → |
| 26: | 10.4 | ↗ |
| 27: | 10.6 | ✕→ |
| 28: | 9.5 | → |
| 29: | 10.5 | ↗ |
| 30: | 10.7 | ↗ |
| Serie | | 98.0 |
| Total | | 679.0 |

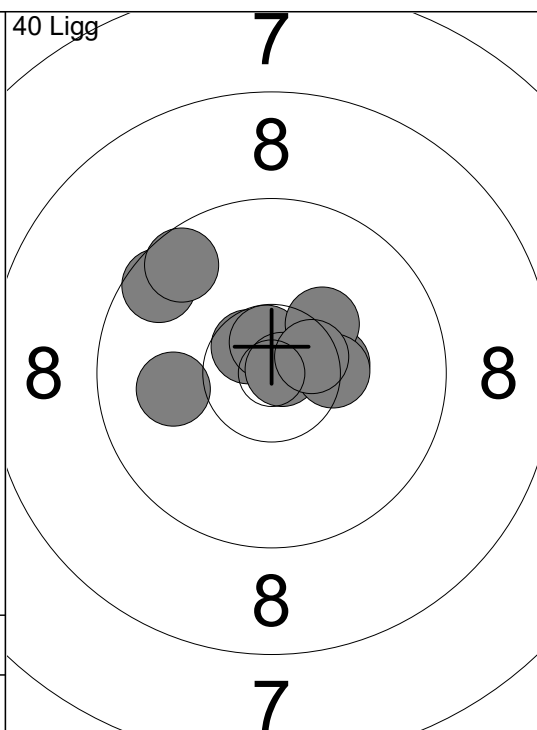

| | | |
|-------|------|-------|
| 31: | 10.6 | ✕↖ |
| 32: | 10.4 | ✕→ |
| 33: | 9.6 | ↖ |
| 34: | 10.7 | ↗ |
| 35: | 10.0 | ← |
| 36: | 10.8 | ✕→ |
| 37: | 9.6 | ↖ |
| 38: | 10.3 | ↗ |
| 39: | 10.4 | ✕→ |
| 40: | 10.5 | ✕→ |
| Serie | | 98.0 |
| Total | | 777.0 |

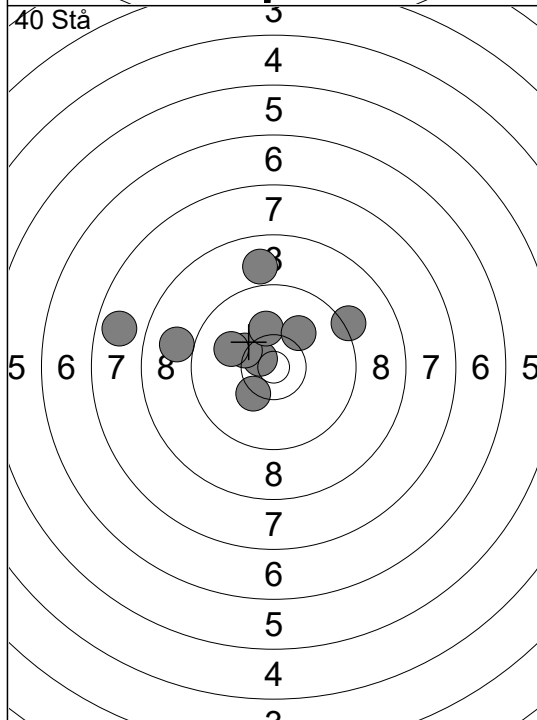

| | | |
|-------|------|-------|
| 1: | 10.6 | ✕↖ |
| 2: | 10.3 | ↖ |
| 3: | 10.3 | ↙ |
| 4: | 9.0 | ← |
| 5: | 8.9 | ↑ |
| 6: | 9.2 | ↗ |
| 7: | 10.2 | ↑ |
| 8: | 10.1 | ↗ |
| 9: | 10.0 | ↖ |
| 10: | 7.8 | ← |
| Serie | | 93.0 |
| Total | | 870.0 |

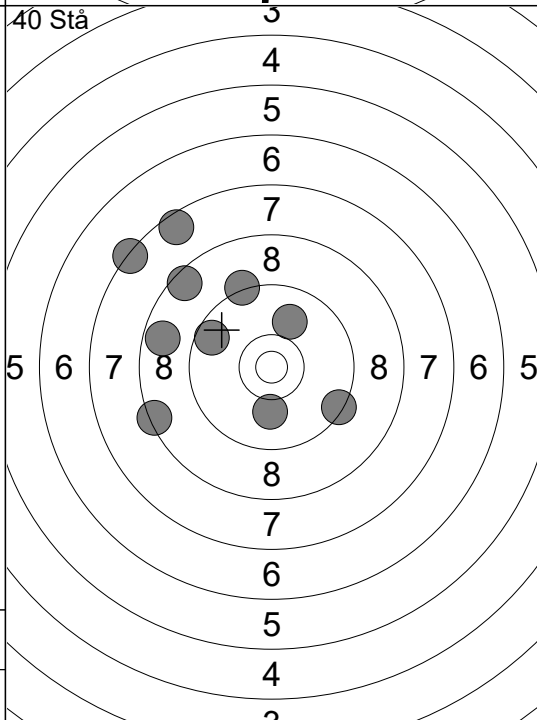

| | | |
|-------|------|-------|
| 11: | 7.4 | ↖ |
| 12: | 10.1 | ↓ |
| 13: | 8.7 | ← |
| 14: | 8.4 | ↙ |
| 15: | 8.5 | ↗ |
| 16: | 9.3 | ↑ |
| 17: | 7.6 | ↗ |
| 18: | 9.6 | ↖ |
| 19: | 9.4 | ↘ |
| 20: | 10.0 | ↑ |
| Serie | | 85.0 |
| Total | | 955.0 |

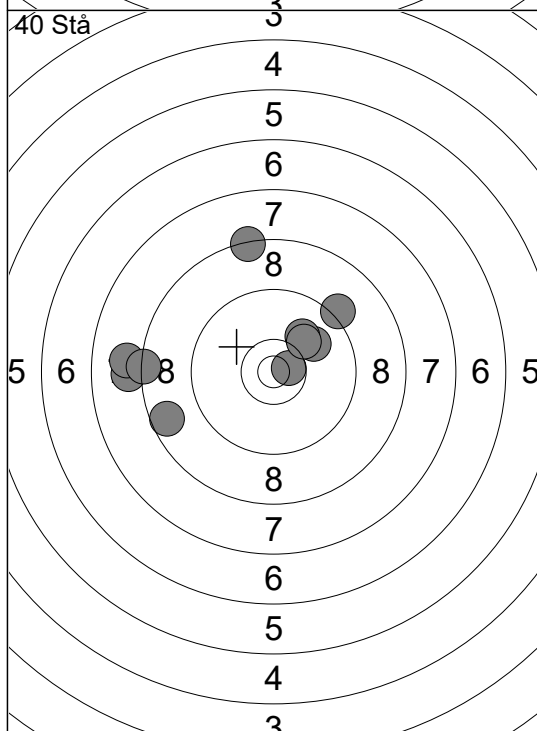

| | | |
|-------|------|--------|
| 21: | 10.0 | ↗ |
| 22: | 8.3 | ↑ |
| 23: | 10.6 | ✕→ |
| 24: | 10.0 | ↗ |
| 25: | 9.2 | ↗ |
| 26: | 8.6 | ← |
| 27: | 8.0 | ← |
| 28: | 8.0 | ← |
| 29: | 8.3 | ← |
| 30: | 10.1 | ↗ |
| Serie | | 89.0 |
| Total | | 1044.0 |

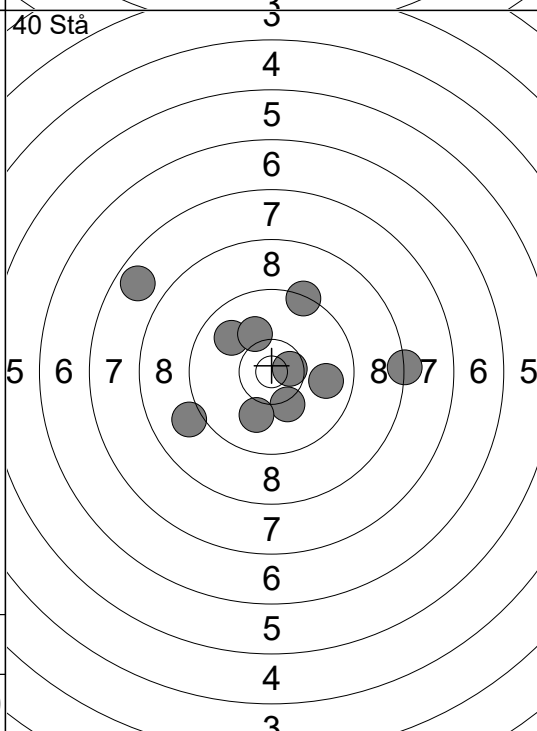

| | | |
|-------|------|--------|
| 31: | 9.9 | ↖ |
| 32: | 10.6 | ✕→ |
| 33: | 10.1 | ↗ |
| 34: | 7.7 | ↖ |
| 35: | 9.4 | ↗ |
| 36: | 9.0 | ← |
| 37: | 10.2 | ↓ |
| 38: | 9.8 | → |
| 39: | 10.0 | ↓ |
| 40: | 8.3 | → |
| Serie | | 91.0 |
| Total | | 1135.0 |

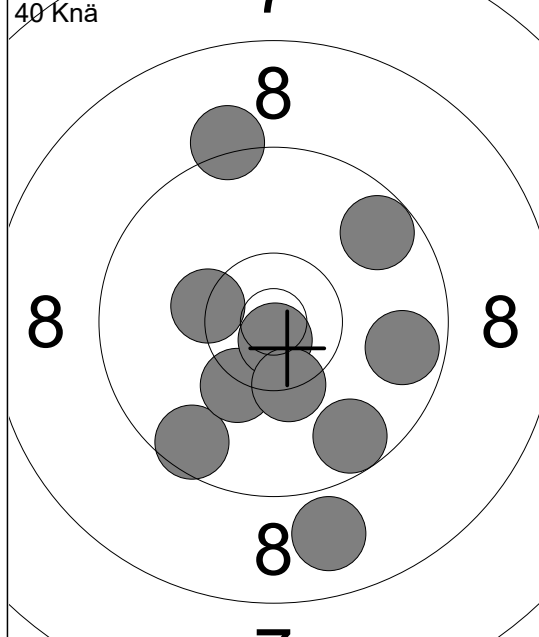

| | |
|-------|---------|
| 1: | 9.6 ↙ |
| 2: | 10.3 ↘ |
| 3: | 10.3 ↘ |
| 4: | 9.7 → |
| 5: | 8.9 ↓ |
| 6: | 10.8x ↓ |
| 7: | 9.7 ↓ |
| 8: | 9.7 ↗ |
| 9: | 9.2 ↑ |
| 10: | 10.3x ↓ |
| Serie | 93.0 |
| Total | 93.0 |

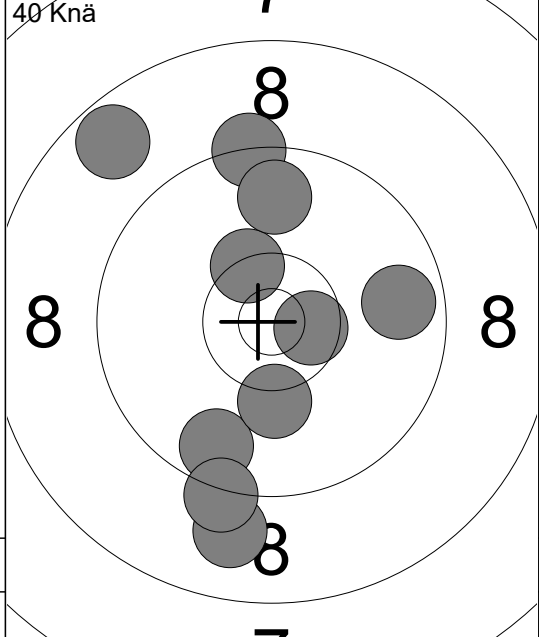

| | |
|-------|---------|
| 11: | 9.7 → |
| 12: | 8.9 ↓ |
| 13: | 10.6x → |
| 14: | 9.7 ↓ |
| 15: | 10.4x ↗ |
| 16: | 10.2 ↓ |
| 17: | 9.3 ↑ |
| 18: | 9.2 ↓ |
| 19: | 8.7 ↖ |
| 20: | 9.8 ↑ |
| Serie | 91.0 |
| Total | 184.0 |

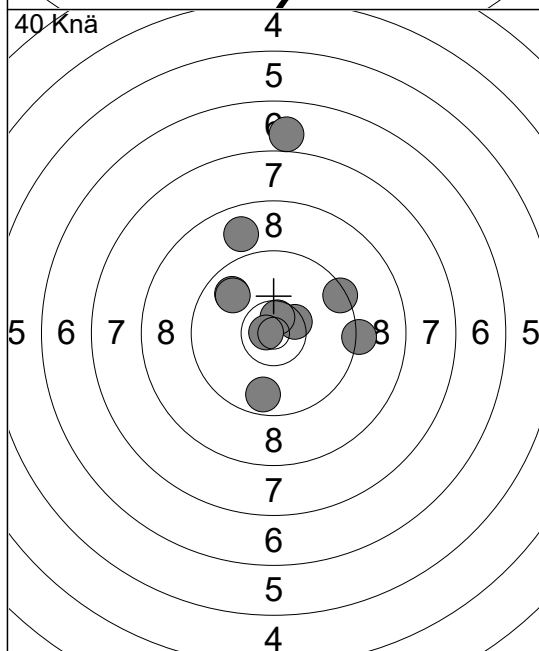

| | |
|-------|---------|
| 21: | 9.8 ↖ |
| 22: | 9.2 → |
| 23: | 9.4 ↗ |
| 24: | 9.8 ↖ |
| 25: | 10.5x ↗ |
| 26: | 8.9 ↑ |
| 27: | 6.9 ↑ |
| 28: | 10.6x ↗ |
| 29: | 10.8x ↖ |
| 30: | 9.7 ↓ |
| Serie | 89.0 |
| Total | 273.0 |

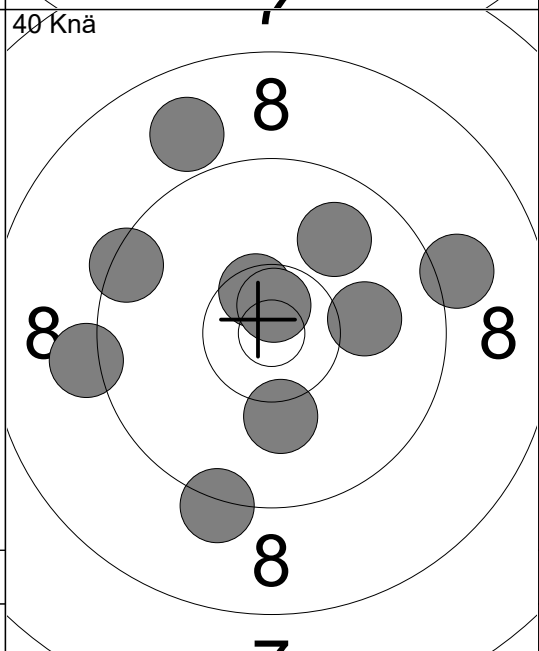

| | |
|-------|---------|
| 31: | 8.9 ↑ |
| 32: | 10.2 ↓ |
| 33: | 9.4 ↖ |
| 34: | 9.1 → |
| 35: | 9.2 ↓ |
| 36: | 9.2 ← |
| 37: | 10.5x ↗ |
| 38: | 9.9 ↗ |
| 39: | 10.1 → |
| 40: | 10.7x ↗ |
| Serie | 93.0 |
| Total | 366.0 |

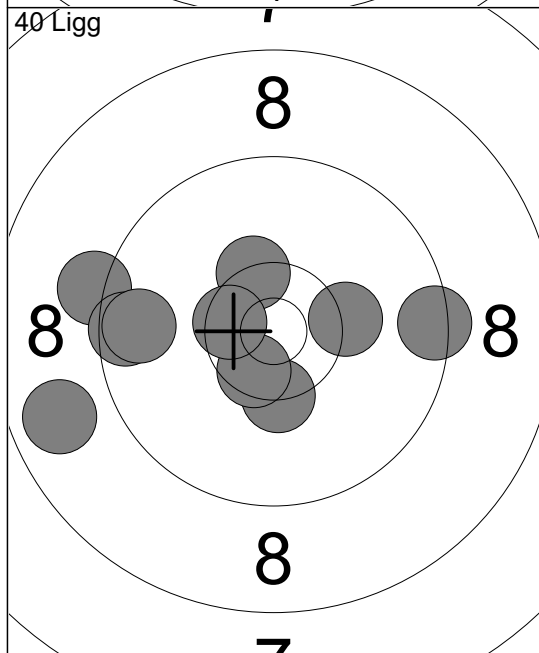

| | |
|-------|---------|
| 1: | 10.3x ↓ |
| 2: | 10.5x ↓ |
| 3: | 9.2 ← |
| 4: | 9.6 ← |
| 5: | 8.8 ← |
| 6: | 9.7 ← |
| 7: | 10.4x ↗ |
| 8: | 10.5x ↖ |
| 9: | 9.4 → |
| 10: | 10.3 → |
| Serie | 94.0 |
| Total | 460.0 |

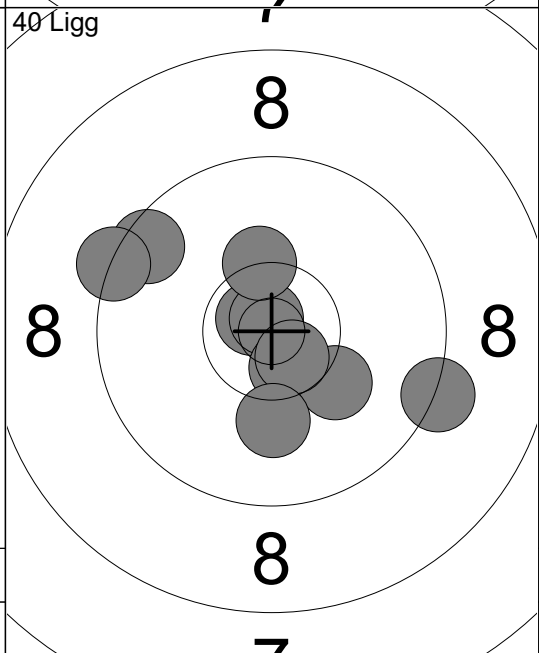

| | |
|-------|---------|
| 11: | 10.7x ↖ |
| 12: | 9.3 → |
| 13: | 9.5 ↖ |
| 14: | 10.8x ↗ |
| 15: | 10.3x ↗ |
| 16: | 10.6x ↓ |
| 17: | 9.3 ← |
| 18: | 10.2 ↘ |
| 19: | 10.6x ↗ |
| 20: | 10.1 ↓ |
| Serie | 97.0 |
| Total | 557.0 |

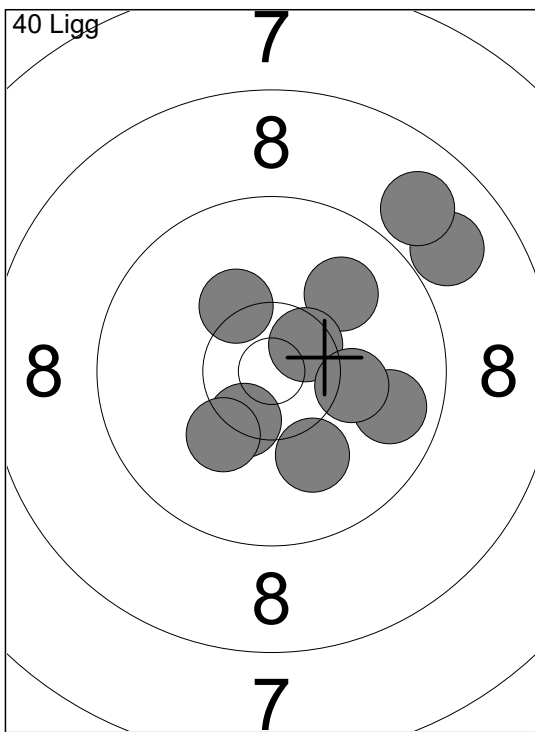

| | | |
|-------|-------|---|
| 21: | 8.9 | ↗ |
| 22: | 10.4 | ✗ |
| 23: | 9.8 | → |
| 24: | 10.1 | ↘ |
| 25: | 10.2 | ↘ |
| 26: | 10.0 | ↗ |
| 27: | 10.5 | ↗ |
| 28: | 10.3 | ↖ |
| 29: | 10.2 | → |
| 30: | 8.9 | ↗ |
| Serie | 95.0 | |
| Total | 652.0 | |

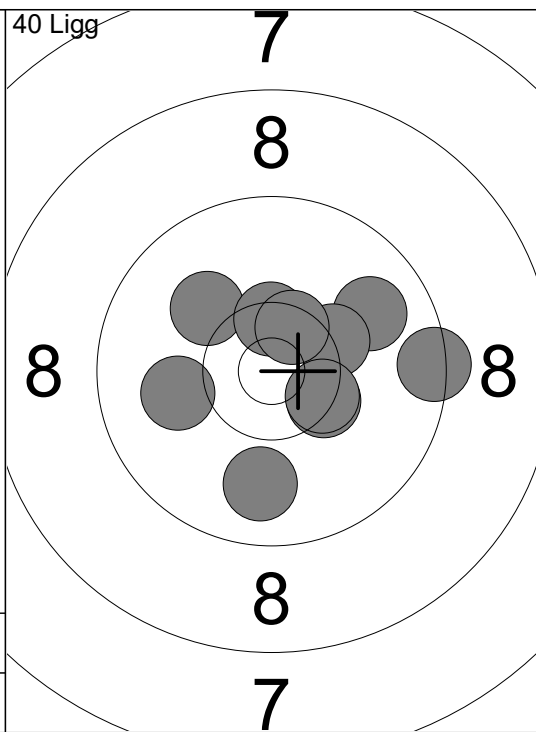

| | | |
|-------|-------|---|
| 31: | 9.9 | ↗ |
| 32: | 10.1 | ↖ |
| 33: | 10.5 | ↗ |
| 34: | 10.3 | ↗ |
| 35: | 10.5 | ↗ |
| 36: | 9.9 | ↓ |
| 37: | 10.4 | ✗ |
| 38: | 10.4 | ✗ |
| 39: | 10.0 | ← |
| 40: | 9.4 | → |
| Serie | 97.0 | |
| Total | 749.0 | |

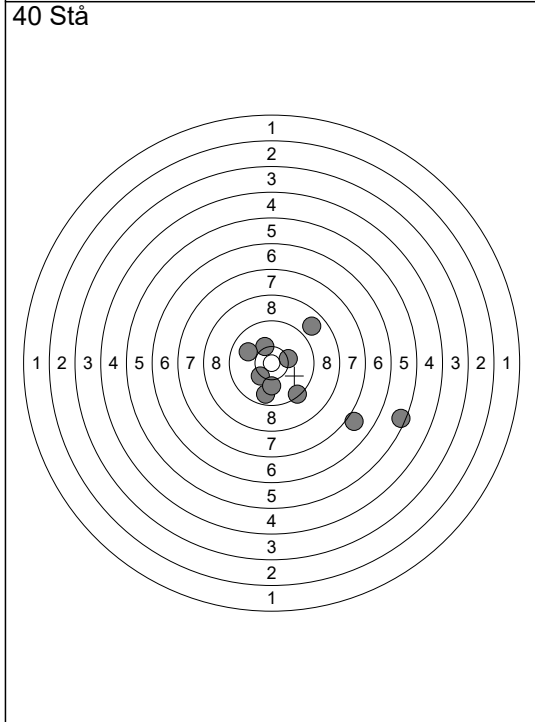

| | | |
|-------|-------|---|
| 1: | 10.2 | ↖ |
| 2: | 10.3 | ✗ |
| 3: | 9.7 | ↓ |
| 4: | 10.3 | → |
| 5: | 10.1 | ↓ |
| 6: | 9.9 | ← |
| 7: | 5.5 | → |
| 8: | 9.4 | ↓ |
| 9: | 7.0 | ↓ |
| 10: | 8.8 | ↗ |
| Serie | 87.0 | |
| Total | 836.0 | |

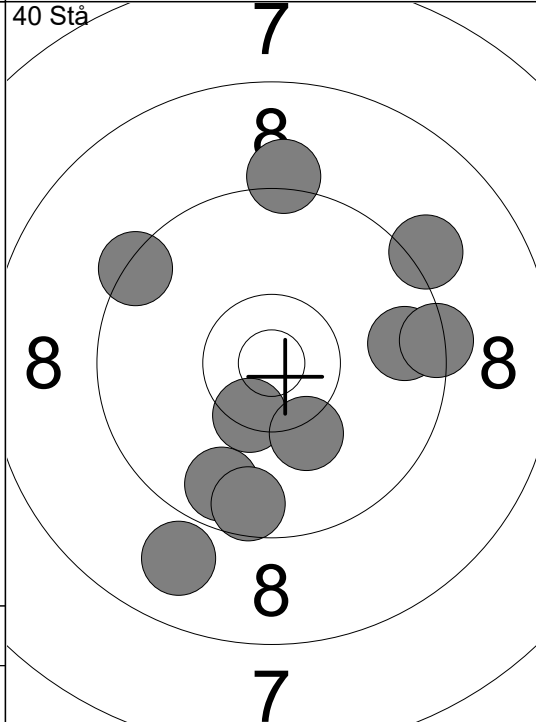

| | | |
|-------|-------|---|
| 11: | 9.4 | ↖ |
| 12: | 9.7 | ↓ |
| 13: | 9.2 | ↑ |
| 14: | 9.6 | ↓ |
| 15: | 10.4 | ✗ |
| 16: | 10.2 | ↓ |
| 17: | 8.9 | ↓ |
| 18: | 9.2 | ↗ |
| 19: | 9.7 | → |
| 20: | 9.4 | → |
| Serie | 91.0 | |
| Total | 927.0 | |

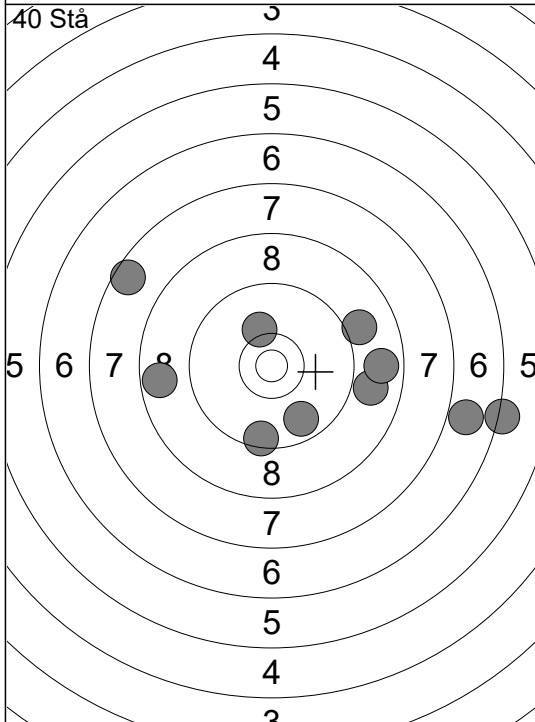

| | | |
|-------|--------|---|
| 21: | 10.2 | ↖ |
| 22: | 8.9 | → |
| 23: | 6.9 | → |
| 24: | 6.2 | → |
| 25: | 9.7 | ↓ |
| 26: | 8.7 | → |
| 27: | 9.5 | ↓ |
| 28: | 7.6 | ↖ |
| 29: | 8.7 | ← |
| 30: | 9.0 | → |
| Serie | 80.0 | |
| Total | 1007.0 | |

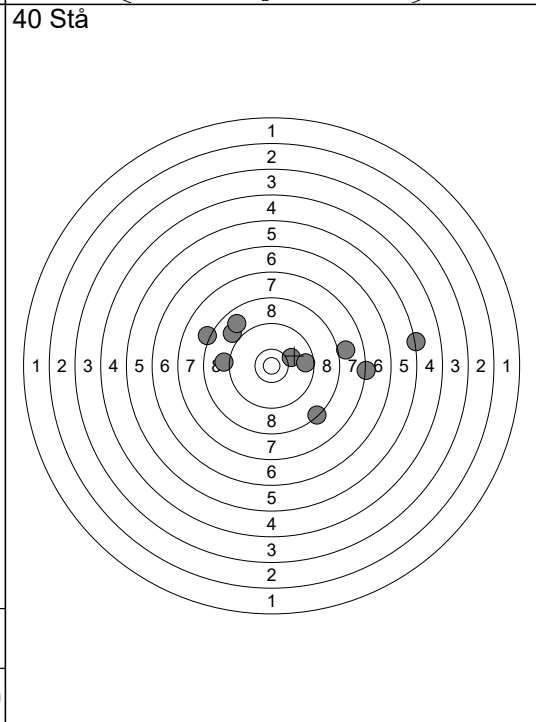

| | | |
|-------|--------|---|
| 31: | 10.1 | ↗ |
| 32: | 9.0 | ↖ |
| 33: | 9.1 | ← |
| 34: | 5.3 | → |
| 35: | 8.0 | → |
| 36: | 8.3 | ↘ |
| 37: | 7.3 | → |
| 38: | 9.6 | → |
| 39: | 8.8 | ↖ |
| 40: | 8.2 | ↖ |
| Serie | 81.0 | |
| Total | 1088.0 | |

| | | | |
|-------------|--|--|--|
| Granngården | | | |
|-------------|--|--|--|

| | | | |
|------------|---------------------|------------------|--|
| 05.05.2018 | Trolltäffen/GP 2018 | Trollhättans SKF | |
|------------|---------------------|------------------|--|

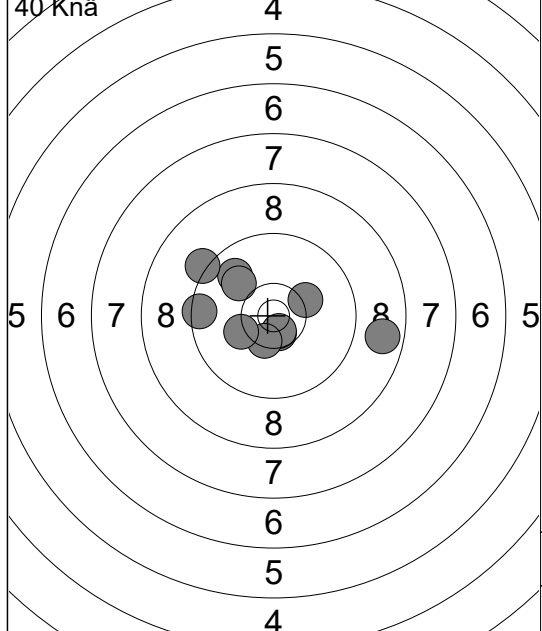

| | |
|----------|------|
| 1: 10.6x | ↘ |
| 2: 9.8 | ↗ |
| 3: 10.0 | ↖ |
| 4: 10.6x | ↘ |
| 5: 9.2 | ↖ |
| 6: 10.2 | ↗ |
| 7: 8.7 | → |
| 8: 10.4x | ↘ |
| 9: 10.2 | ↙ |
| 10: 9.5 | ← |
| Serie | 95.0 |
| Total | 95.0 |

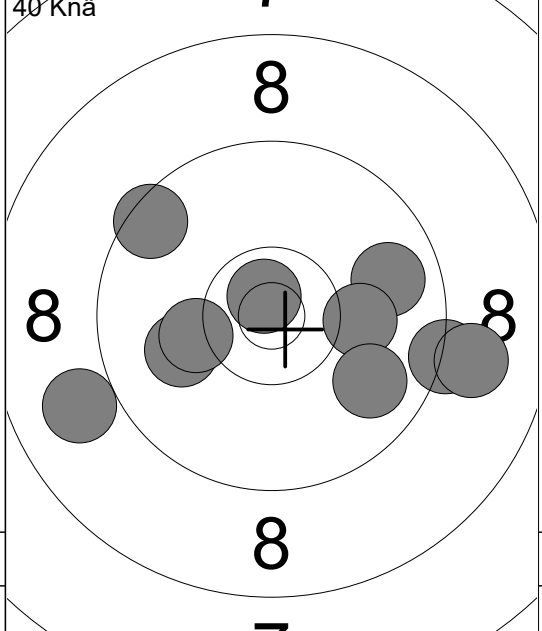

| | |
|-----------|-------|
| 11: 9.3 | → |
| 12: 8.9 | ↙ |
| 13: 9.0 | → |
| 14: 10.0 | ↙ |
| 15: 10.2 | ↙ |
| 16: 10.7x | ↖ |
| 17: 9.8 | → |
| 18: 9.5 | ↖ |
| 19: 10.1 | → |
| 20: 9.8 | ↘ |
| Serie | 93.0 |
| Total | 188.0 |

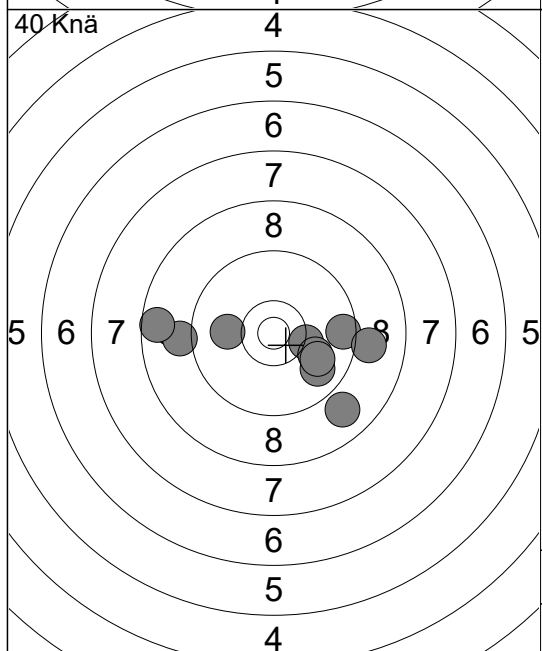

| | |
|----------|-------|
| 21: 10.0 | ← |
| 22: 8.9 | ↘ |
| 23: 10.3 | → |
| 24: 9.8 | ↘ |
| 25: 9.6 | → |
| 26: 10.0 | → |
| 27: 9.0 | → |
| 28: 9.9 | ↘ |
| 29: 9.1 | ← |
| 30: 8.6 | ← |
| Serie | 91.0 |
| Total | 279.0 |

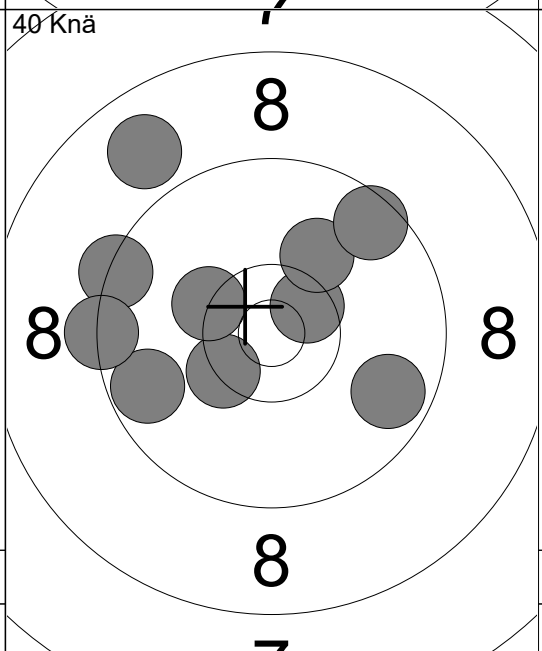

| | |
|-----------|-------|
| 31: 9.4 | ↙ |
| 32: 10.5x | ↗ |
| 33: 8.9 | ↖ |
| 34: 10.4x | ↘ |
| 35: 10.1 | ↗ |
| 36: 9.6 | ↗ |
| 37: 9.7 | ↘ |
| 38: 9.7 | ← |
| 39: 10.3x | ↘ |
| 40: 9.3 | ← |
| Serie | 93.0 |
| Total | 372.0 |

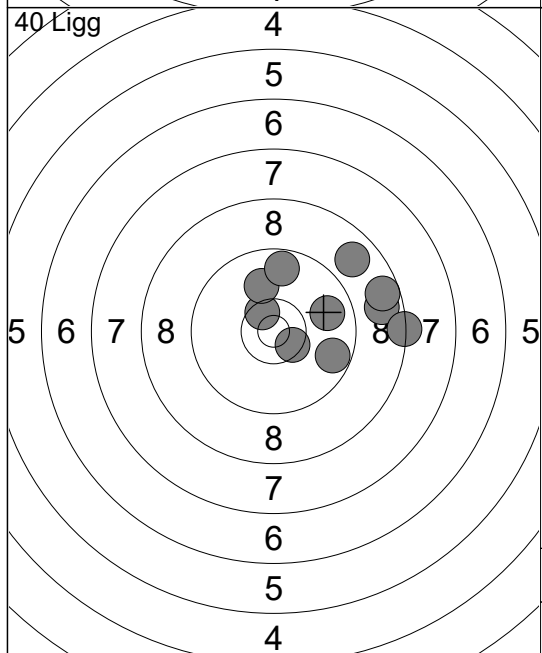

| | |
|----------|-------|
| 1: 10.5x | ↖ |
| 2: 8.8 | ↗ |
| 3: 10.0 | ↖ |
| 4: 8.7 | → |
| 5: 9.8 | → |
| 6: 10.5x | ↘ |
| 7: 9.7 | ↑ |
| 8: 8.3 | → |
| 9: 8.6 | → |
| 10: 9.7 | ↘ |
| Serie | 89.0 |
| Total | 461.0 |

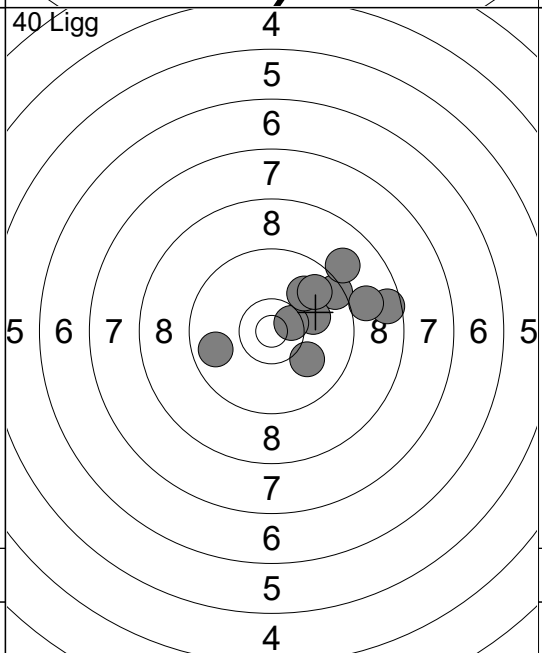

| | |
|-----------|-------|
| 11: 10.0 | ↘ |
| 12: 9.5 | ↗ |
| 13: 8.6 | → |
| 14: 10.1 | → |
| 15: 10.5x | ↗ |
| 16: 9.0 | ↗ |
| 17: 9.0 | → |
| 18: 9.9 | ↗ |
| 19: 9.8 | ↗ |
| 20: 9.8 | ← |
| Serie | 92.0 |
| Total | 553.0 |

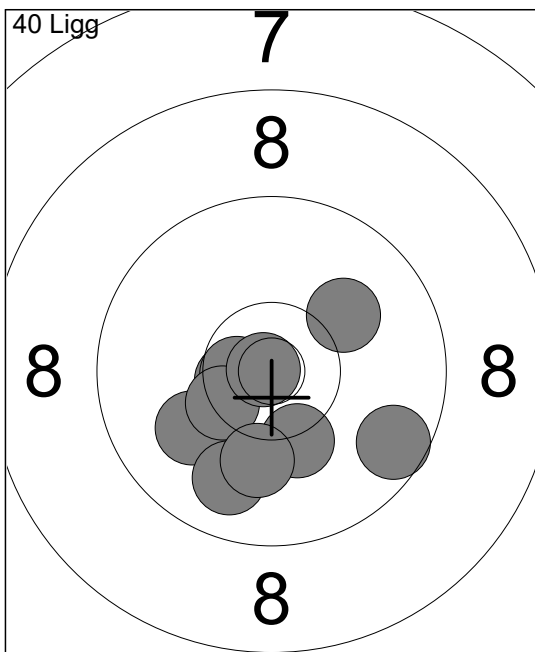

| | |
|-----|--------|
| 21: | 10.6x↖ |
| 22: | 10.0↙ |
| 23: | 10.6x↖ |
| 24: | 10.3↓ |
| 25: | 9.9↓ |
| 26: | 10.4x↖ |
| 27: | 10.9x↖ |
| 28: | 9.6→ |
| 29: | 10.1↓ |
| 30: | 10.1↗ |

| | |
|-------|-------|
| Serie | 98.0 |
| Total | 651.0 |

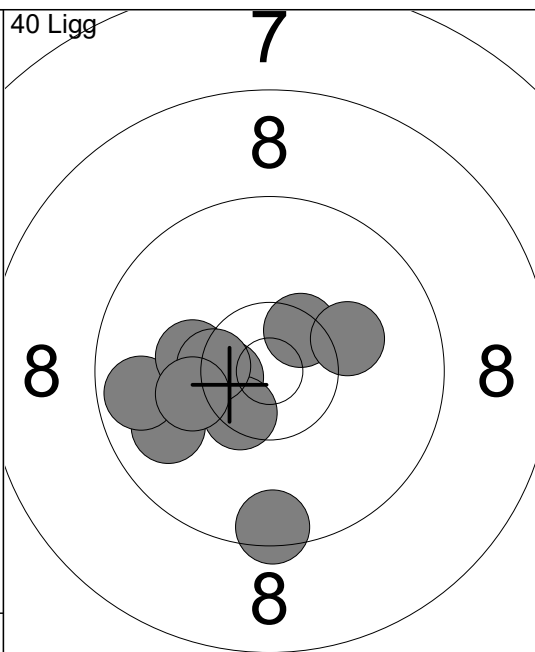

| | |
|-----|--------|
| 31: | 10.5x↗ |
| 32: | 9.9↙ |
| 33: | 10.5x↖ |
| 34: | 9.7← |
| 35: | 10.2↙ |
| 36: | 10.5x↖ |
| 37: | 10.2↗ |
| 38: | 10.4x↖ |
| 39: | 10.2↙ |
| 40: | 9.5↓ |

| | |
|-------|-------|
| Serie | 97.0 |
| Total | 748.0 |

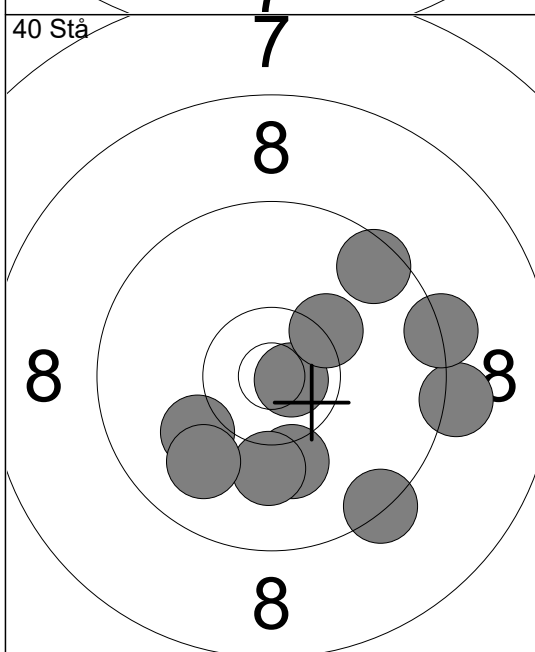

| | |
|-----|--------|
| 1: | 10.1↓ |
| 2: | 10.8x→ |
| 3: | 9.3↓ |
| 4: | 10.1↓ |
| 5: | 10.1↙ |
| 6: | 9.2→ |
| 7: | 9.5↗ |
| 8: | 9.9↙ |
| 9: | 10.3↗ |
| 10: | 9.3→ |

| | |
|-------|-------|
| Serie | 95.0 |
| Total | 843.0 |

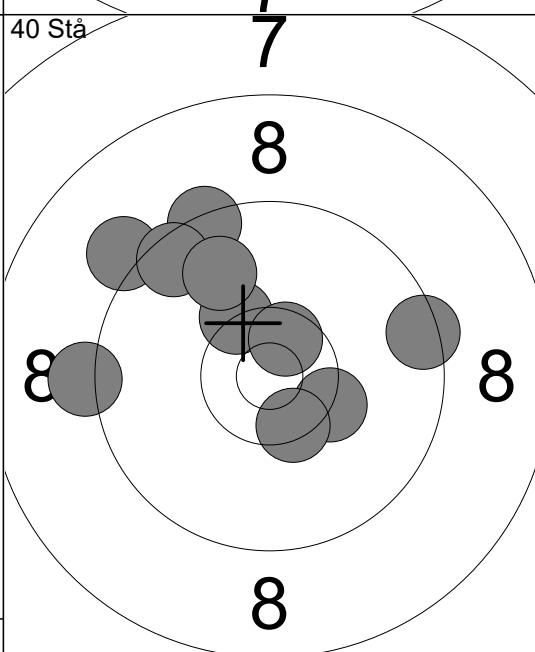

| | |
|-----|--------|
| 11: | 9.2↖ |
| 12: | 10.3x↖ |
| 13: | 9.4↗ |
| 14: | 10.3x↖ |
| 15: | 9.5↖ |
| 16: | 10.6x↗ |
| 17: | 10.4x↘ |
| 18: | 9.2← |
| 19: | 9.4→ |
| 20: | 9.9↖ |

| | |
|-------|-------|
| Serie | 94.0 |
| Total | 937.0 |

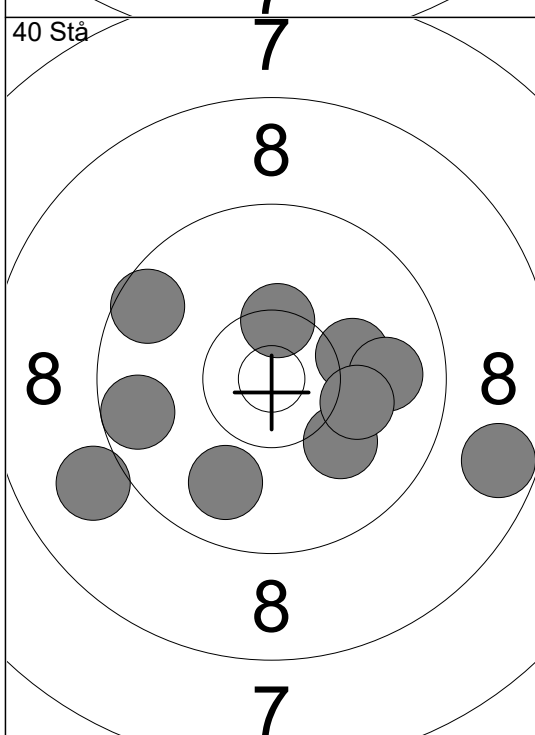

| | |
|-----|--------|
| 21: | 9.6↖ |
| 22: | 10.2→ |
| 23: | 8.7→ |
| 24: | 10.1↓ |
| 25: | 9.9→ |
| 26: | 9.9↙ |
| 27: | 10.1→ |
| 28: | 10.4x↗ |
| 29: | 9.0↙ |
| 30: | 9.6← |

| | |
|-------|--------|
| Serie | 93.0 |
| Total | 1030.0 |

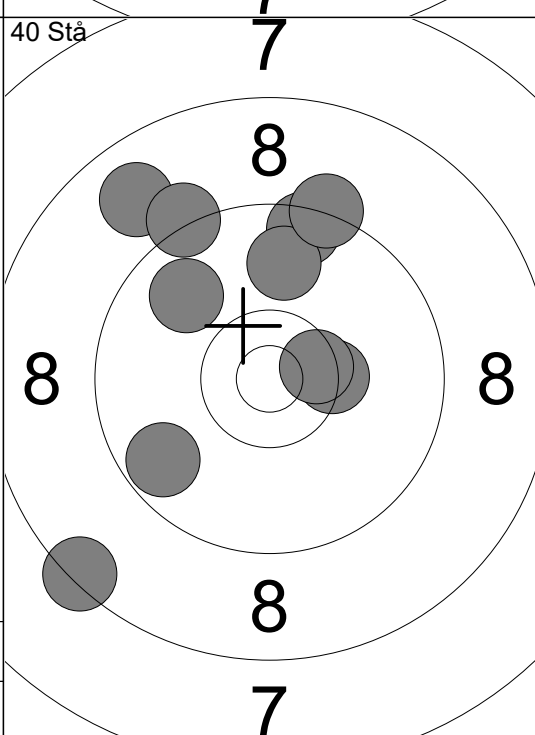

| | |
|-----|--------|
| 31: | 9.7↙ |
| 32: | 8.8↖ |
| 33: | 10.4x→ |
| 34: | 9.2↖ |
| 35: | 8.4↙ |
| 36: | 9.8↖ |
| 37: | 10.5x→ |
| 38: | 9.5↗ |
| 39: | 9.9↗ |
| 40: | 9.3↗ |

| | |
|-------|--------|
| Serie | 90.0 |
| Total | 1120.0 |

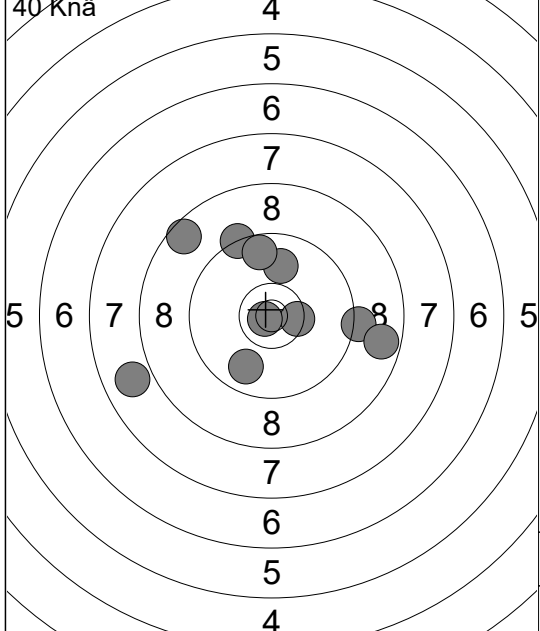

| | | |
|-------|------|------|
| 1: | 9.3 | ↗ |
| 2: | 7.9 | ↖ |
| 3: | 9.9 | ↗ |
| 4: | 9.2 | → |
| 5: | 8.7 | → |
| 6: | 10.4 | x→ |
| 7: | 8.6 | ↖ |
| 8: | 10.8 | x↖ |
| 9: | 9.7 | ↗ |
| 10: | 9.8 | ↘ |
| Serie | | 88.0 |
| Total | | 88.0 |

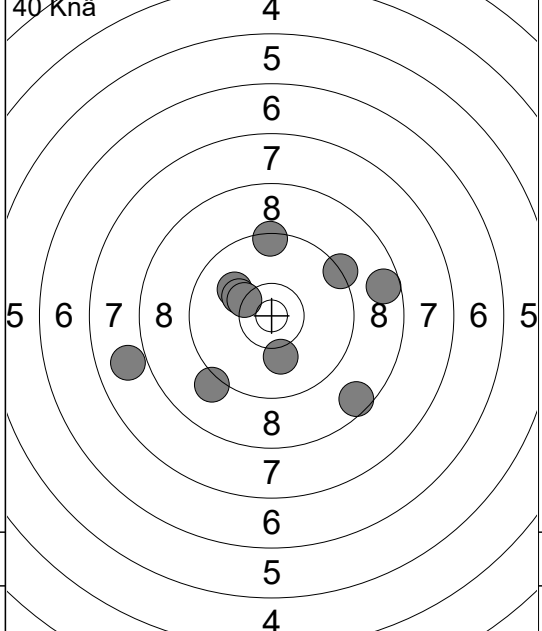

| | | |
|-------|------|-------|
| 11: | 8.6 | ↘ |
| 12: | 10.1 | ↘ |
| 13: | 8.6 | → |
| 14: | 9.1 | ↖ |
| 15: | 9.3 | ↗ |
| 16: | 10.0 | ↖ |
| 17: | 10.2 | ↖ |
| 18: | 10.3 | x↖ |
| 19: | 7.9 | ↖ |
| 20: | 9.4 | ↗ |
| Serie | | 90.0 |
| Total | | 178.0 |

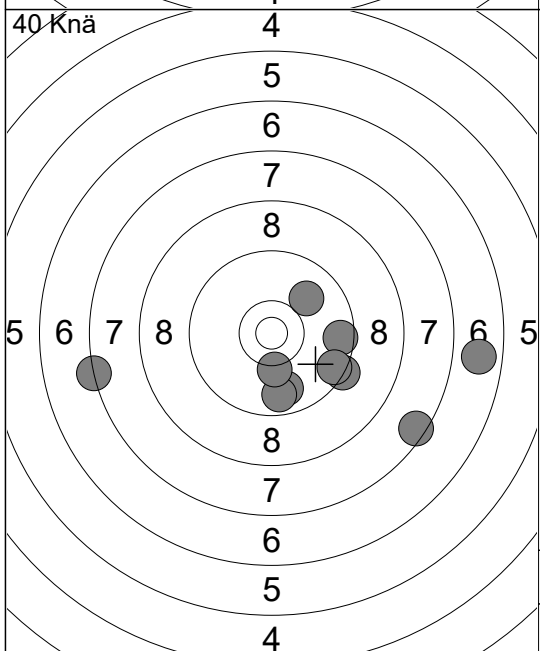

| | | |
|-------|------|-------|
| 21: | 9.6 | → |
| 22: | 7.3 | ↖ |
| 23: | 9.8 | ↘ |
| 24: | 9.3 | → |
| 25: | 7.5 | ↘ |
| 26: | 6.8 | → |
| 27: | 9.5 | → |
| 28: | 9.7 | ↘ |
| 29: | 10.0 | ↗ |
| 30: | 10.2 | ↘ |
| Serie | | 85.0 |
| Total | | 263.0 |

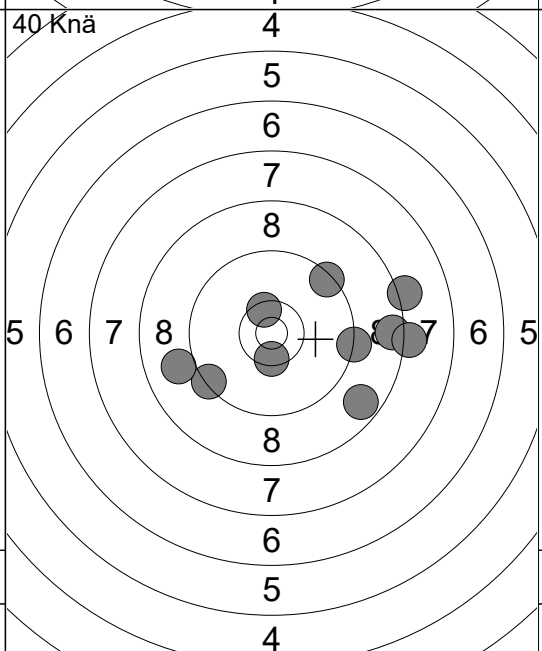

| | | |
|-------|------|-------|
| 31: | 10.4 | x↘ |
| 32: | 9.4 | ↖ |
| 33: | 8.5 | → |
| 34: | 9.3 | → |
| 35: | 8.7 | ↘ |
| 36: | 8.2 | → |
| 37: | 10.5 | x↗ |
| 38: | 8.2 | → |
| 39: | 9.4 | ↗ |
| 40: | 9.0 | ↖ |
| Serie | | 88.0 |
| Total | | 351.0 |

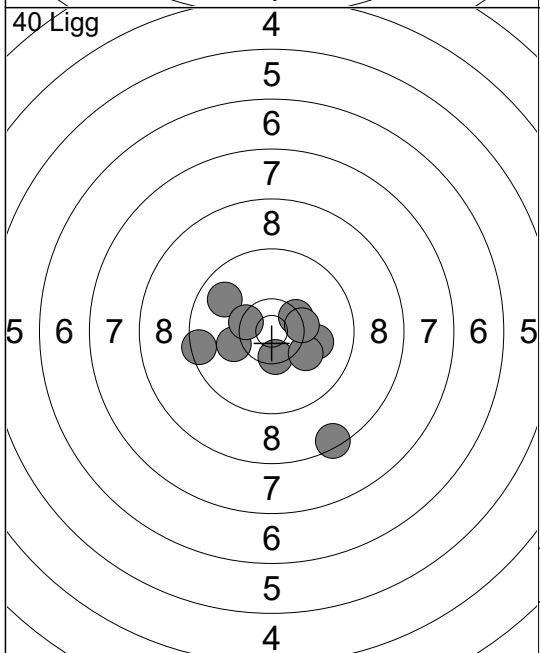

| | | |
|-------|------|-------|
| 1: | 10.4 | x↘ |
| 2: | 10.2 | ↖ |
| 3: | 9.8 | ↖ |
| 4: | 9.5 | ↖ |
| 5: | 10.4 | x↖ |
| 6: | 10.0 | → |
| 7: | 10.1 | ↘ |
| 8: | 10.4 | x↗ |
| 9: | 8.4 | ↘ |
| 10: | 10.3 | x→ |
| Serie | | 96.0 |
| Total | | 447.0 |

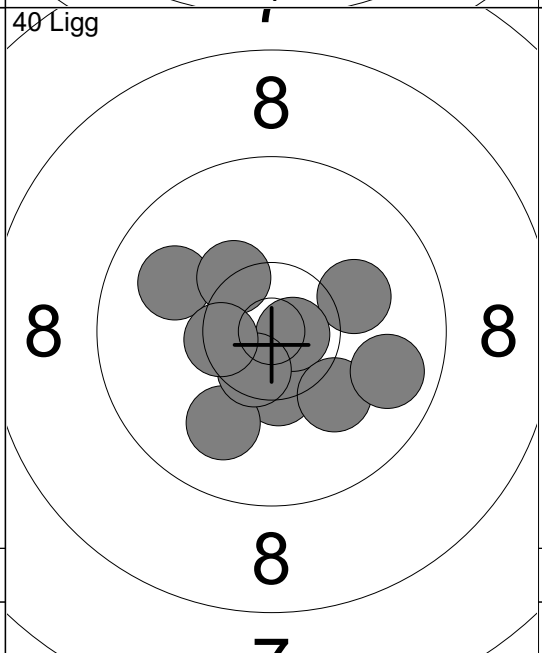

| | | |
|-------|------|-------|
| 11: | 9.9 | ↖ |
| 12: | 10.3 | x↖ |
| 13: | 10.4 | x↘ |
| 14: | 10.1 | → |
| 15: | 10.0 | ↘ |
| 16: | 10.7 | x→ |
| 17: | 10.6 | x↘ |
| 18: | 10.1 | ↘ |
| 19: | 9.8 | → |
| 20: | 10.5 | x↖ |
| Serie | | 98.0 |
| Total | | 545.0 |

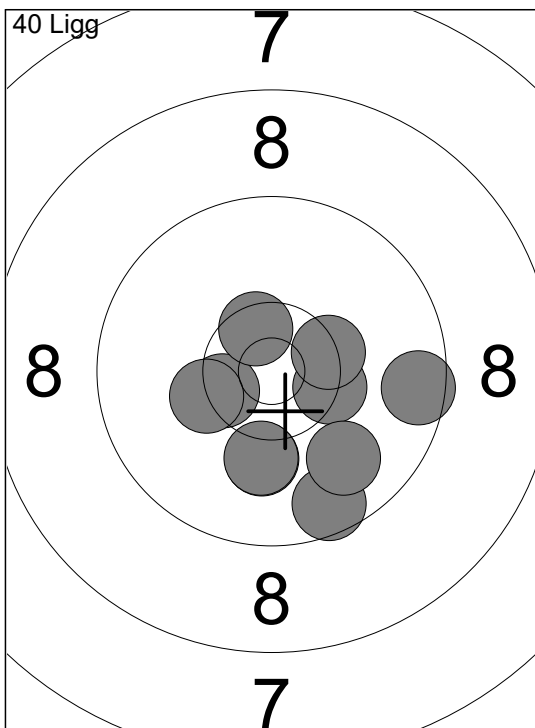

- 21: 10.4x
- 22: 10.1 ↓
- 23: 9.6 →
- 24: 10.4x
- 25: 10.4x
- 26: 10.3x
- 27: 10.1 ↓
- 28: 10.5x
- 29: 9.6 ↓
- 30: 9.9 ↓

Serie 97.0
Total 642.0

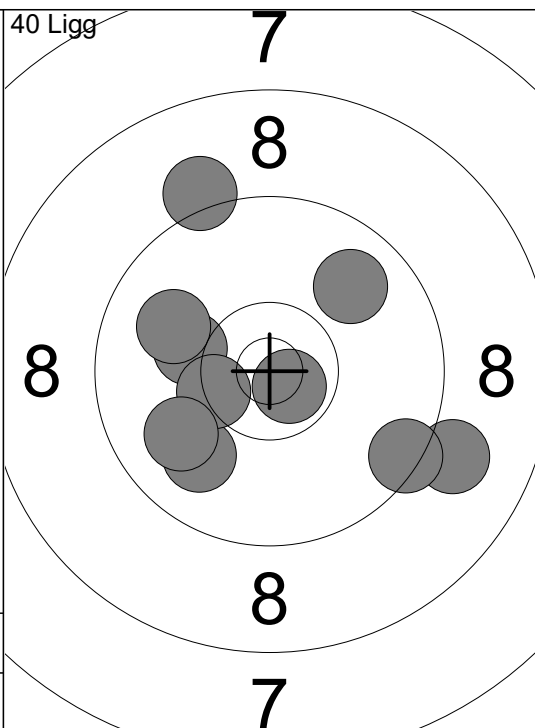

- 31: 9.8 ↗
- 32: 9.1 ↖
- 33: 9.9 ↙
- 34: 10.2 ↖
- 35: 10.4x
- 36: 10.0 ↖
- 37: 9.0 →
- 38: 9.4 ↘
- 39: 9.9 ↙
- 40: 10.7x

Serie 94.0
Total 736.0

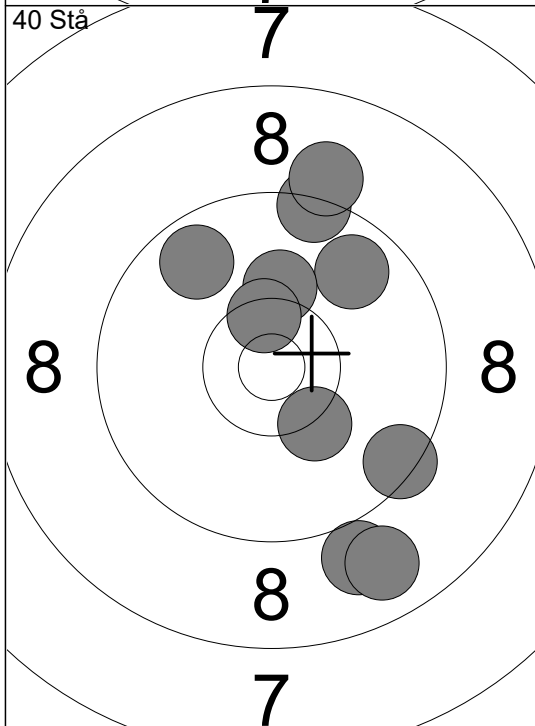

- 1: 9.8 ↗
- 2: 10.2 ↑
- 3: 10.5x
- 4: 9.0 ↓
- 5: 9.4 ↑
- 6: 8.8 ↓
- 7: 9.4 ↘
- 8: 9.7 ↗
- 9: 10.3 ↓
- 10: 9.1 ↑

Serie 92.0
Total 828.0

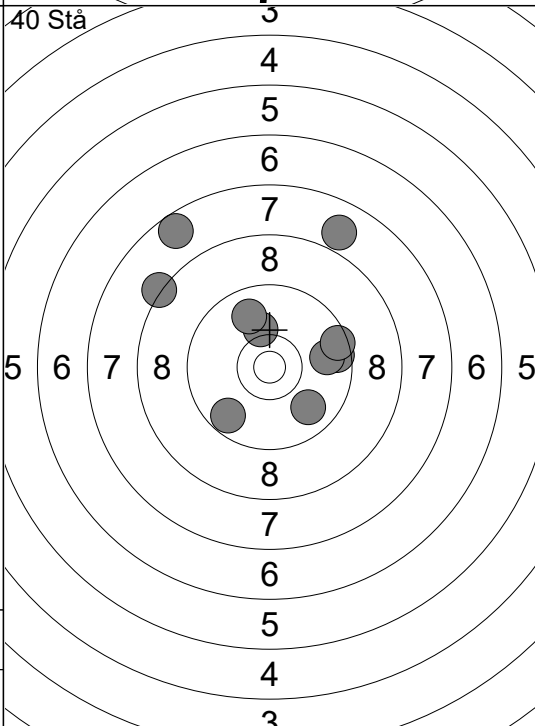

- 11: 9.6 →
- 12: 9.8 →
- 13: 8.3 ↖
- 14: 10.2 ↑
- 15: 9.9 ↗
- 16: 7.9 ↗
- 17: 9.8 ↘
- 18: 9.7 ↙
- 19: 9.5 →
- 20: 7.6 ↖

Serie 86.0
Total 914.0

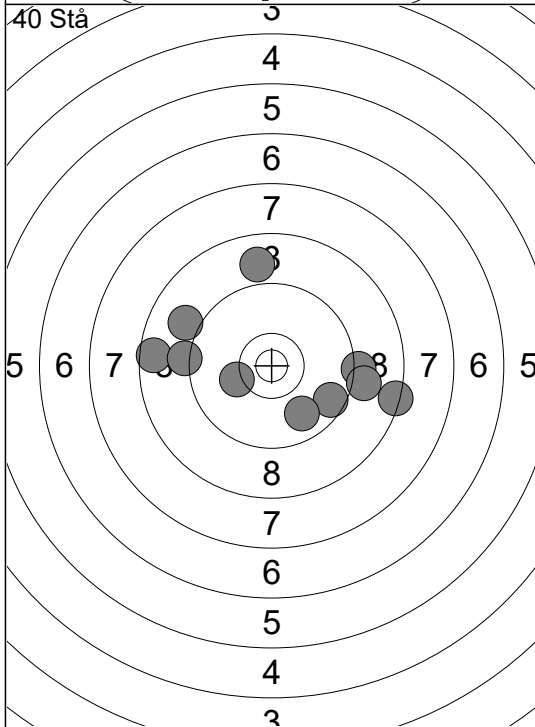

- 21: 8.6 ←
- 22: 8.9 ↑
- 23: 9.2 →
- 24: 9.0 ↖
- 25: 10.2 ↖
- 26: 9.6 ↘
- 27: 9.1 →
- 28: 9.8 ↓
- 29: 9.2 ←
- 30: 8.4 →

Serie 88.0
Total 1002.0

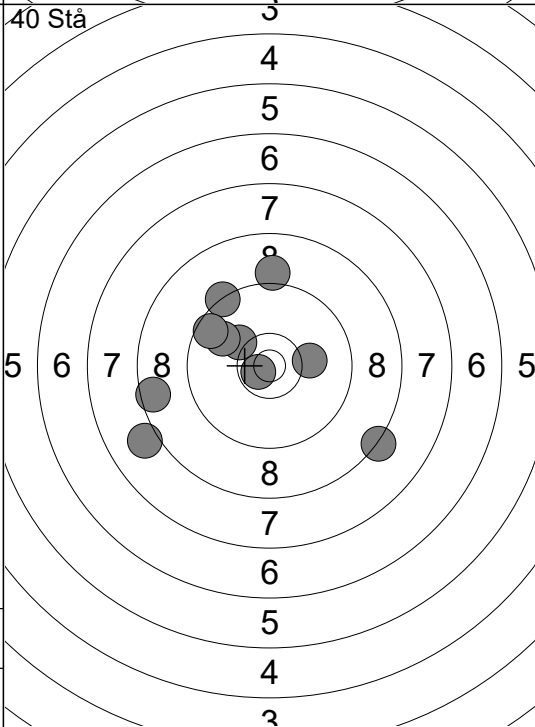

- 31: 10.2 ↖
- 32: 8.3 ↘
- 33: 9.3 ↖
- 34: 10.7x
- 35: 8.5 ←
- 36: 9.9 ↖
- 37: 9.6 ↖
- 38: 10.1 →
- 39: 9.1 ↑
- 40: 8.0 ↙

Serie 90.0
Total 1092.0

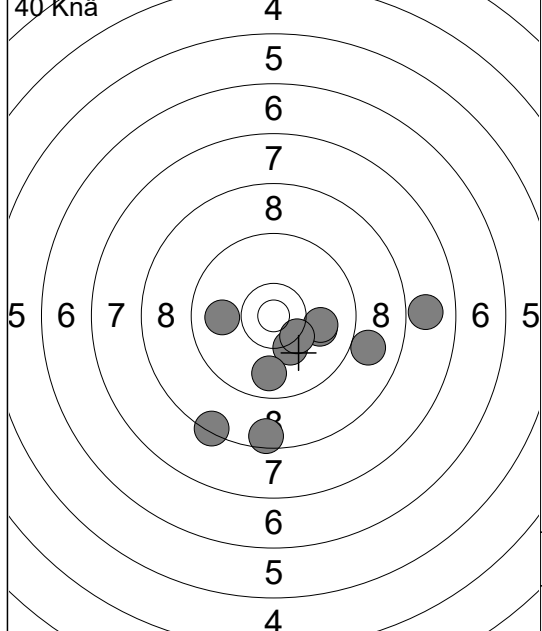

| | |
|-------|---------|
| 1: | 10.0 → |
| 2: | 10.0 → |
| 3: | 8.5 ↓ |
| 4: | 10.2 ↓ |
| 5: | 8.4 ↓ |
| 6: | 9.8 ↓ |
| 7: | 10.3x ↘ |
| 8: | 9.0 → |
| 9: | 9.9 ← |
| 10: | 7.9 → |
| Serie | 90.0 |
| Total | 90.0 |

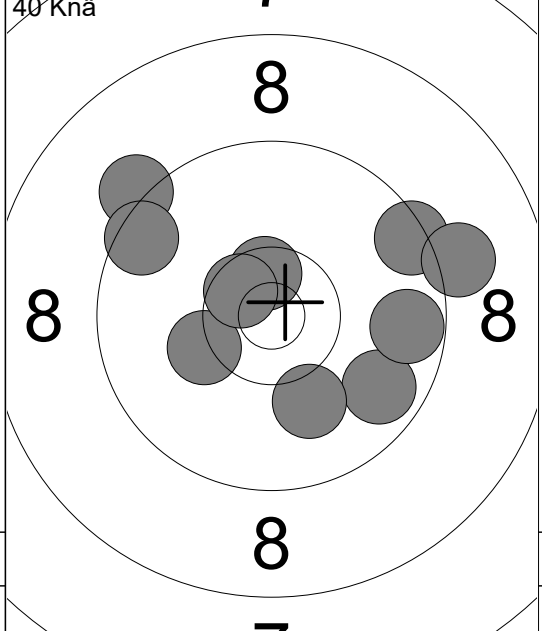

| | |
|-------|---------|
| 11: | 9.7 ↘ |
| 12: | 10.5x ↗ |
| 13: | 10.2 ↙ |
| 14: | 10.6x ↘ |
| 15: | 9.4 ↗ |
| 16: | 10.1 ↓ |
| 17: | 9.2 ↖ |
| 18: | 9.5 ↖ |
| 19: | 9.1 → |
| 20: | 9.7 → |
| Serie | 94.0 |
| Total | 184.0 |

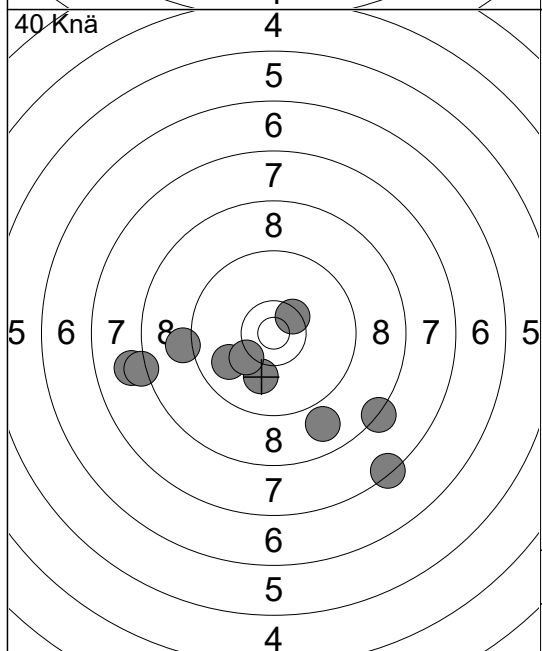

| | |
|-------|---------|
| 21: | 9.9 ↙ |
| 22: | 10.1 ↓ |
| 23: | 10.4x ↗ |
| 24: | 8.9 ↓ |
| 25: | 10.2 ↙ |
| 26: | 9.1 ← |
| 27: | 8.3 ↘ |
| 28: | 7.4 ↓ |
| 29: | 8.0 ← |
| 30: | 8.2 ← |
| Serie | 87.0 |
| Total | 271.0 |

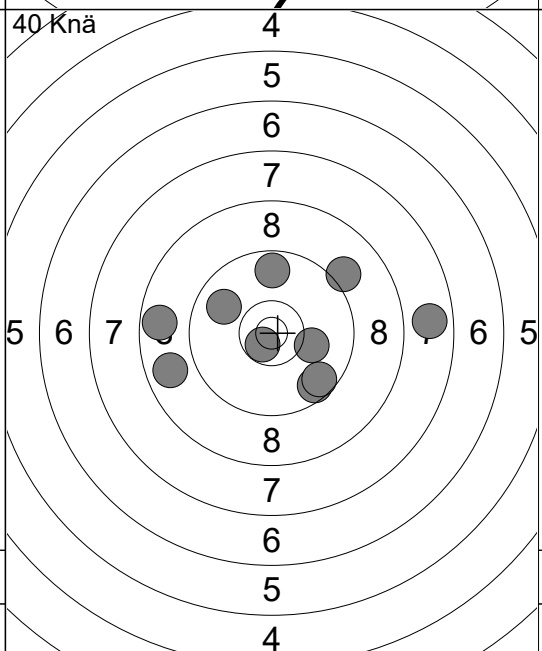

| | |
|-------|---------|
| 31: | 8.8 ← |
| 32: | 10.1 → |
| 33: | 7.8 → |
| 34: | 10.7x ↘ |
| 35: | 9.1 ↗ |
| 36: | 9.7 ↑ |
| 37: | 9.6 ↓ |
| 38: | 8.7 ← |
| 39: | 9.8 ↖ |
| 40: | 9.6 ↓ |
| Serie | 88.0 |
| Total | 359.0 |

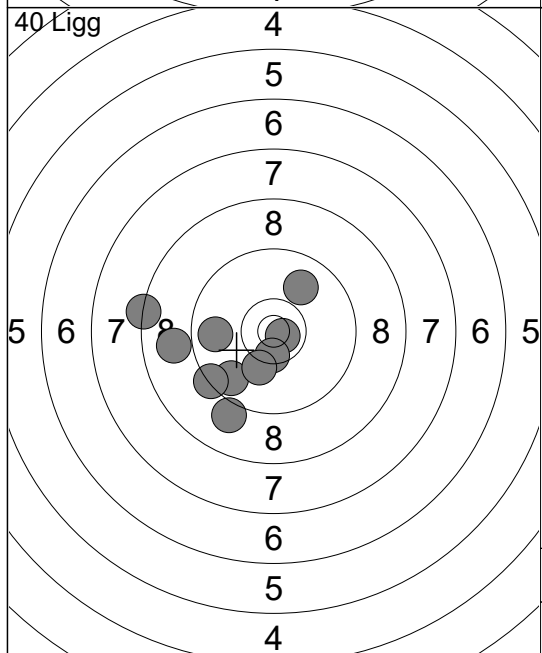

| | |
|-------|---------|
| 1: | 9.7 ↙ |
| 2: | 8.9 ← |
| 3: | 10.7x ↘ |
| 4: | 8.3 ← |
| 5: | 9.8 ← |
| 6: | 9.0 ↓ |
| 7: | 10.5x ↘ |
| 8: | 10.2 ↓ |
| 9: | 9.3 ↙ |
| 10: | 9.9 ↗ |
| Serie | 91.0 |
| Total | 450.0 |

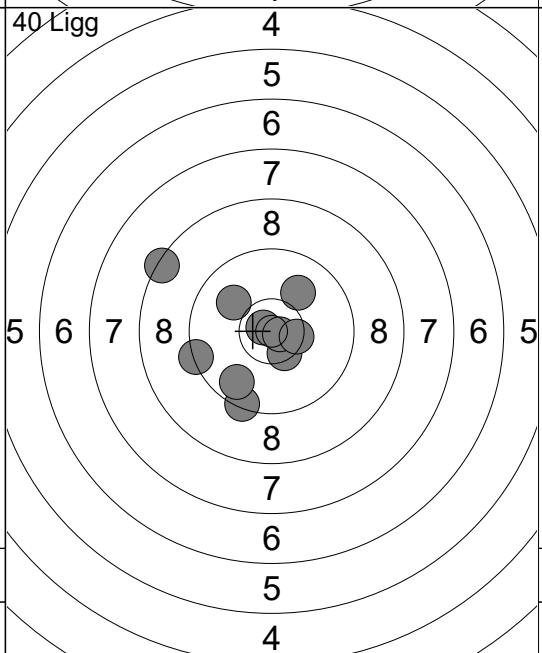

| | |
|-------|---------|
| 11: | 10.8x ↘ |
| 12: | 10.4x ↘ |
| 13: | 9.4 ↓ |
| 14: | 9.3 ← |
| 15: | 8.4 ↖ |
| 16: | 9.7 ↓ |
| 17: | 10.8x ↘ |
| 18: | 10.0 ↖ |
| 19: | 10.0 ↗ |
| 20: | 10.4x ↘ |
| Serie | 95.0 |
| Total | 545.0 |

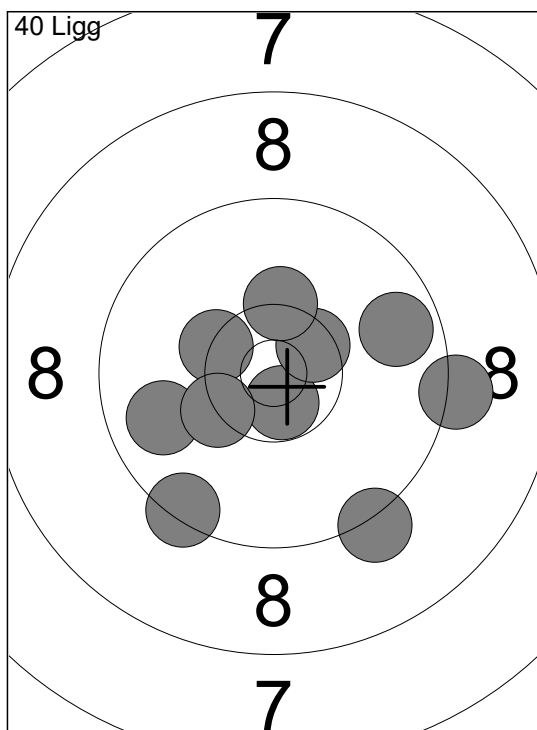

| | |
|-------|-------|
| 21: | 10.7x |
| 22: | 9.7 |
| 23: | 10.5x |
| 24: | 9.8 |
| 25: | 9.2 |
| 26: | 9.4 |
| 27: | 10.3x |
| 28: | 9.2 |
| 29: | 10.4x |
| 30: | 10.3x |
| Serie | 95.0 |
| Total | 640.0 |

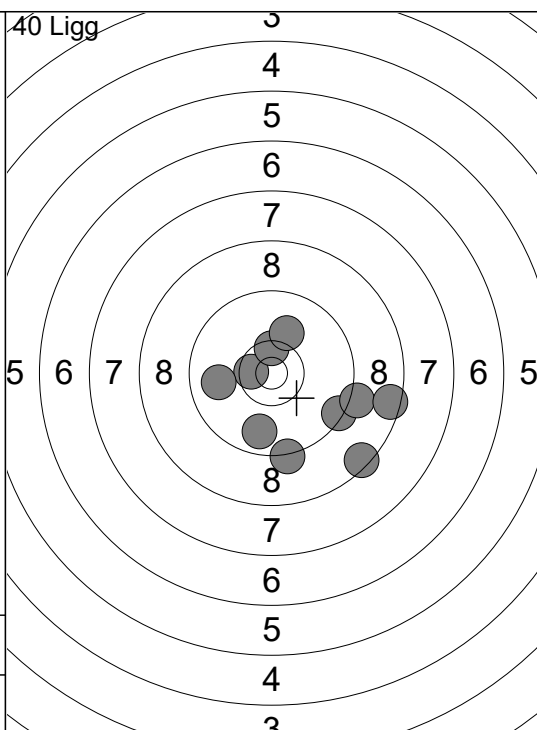

| | |
|-------|-------|
| 31: | 9.4 |
| 32: | 10.5x |
| 33: | 10.5x |
| 34: | 9.9 |
| 35: | 9.3 |
| 36: | 9.2 |
| 37: | 8.4 |
| 38: | 8.5 |
| 39: | 10.1 |
| 40: | 9.8 |
| Serie | 91.0 |
| Total | 731.0 |

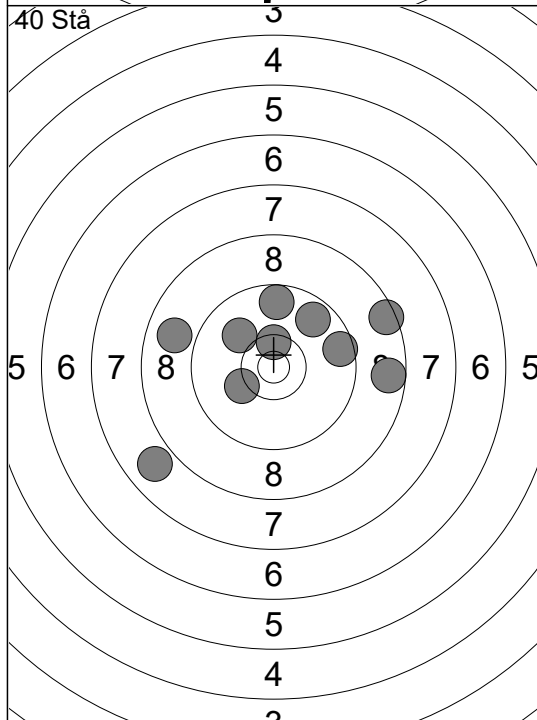

| | |
|-------|-------|
| 1: | 8.5 |
| 2: | 9.6 |
| 3: | 8.6 |
| 4: | 9.6 |
| 5: | 7.9 |
| 6: | 8.9 |
| 7: | 10.0 |
| 8: | 10.5x |
| 9: | 10.2 |
| 10: | 9.7 |
| Serie | 88.0 |
| Total | 819.0 |

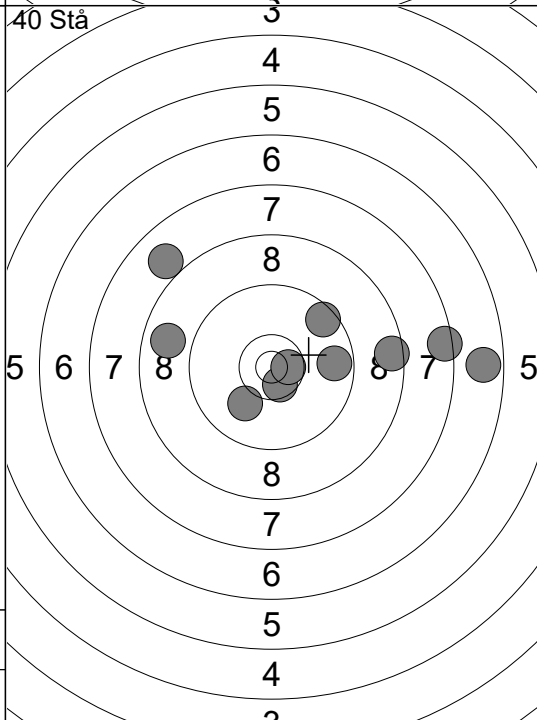

| | |
|-------|-------|
| 11: | 9.5 |
| 12: | 10.6x |
| 13: | 10.1 |
| 14: | 6.7 |
| 15: | 7.4 |
| 16: | 9.7 |
| 17: | 8.5 |
| 18: | 10.6x |
| 19: | 8.8 |
| 20: | 8.0 |
| Serie | 85.0 |
| Total | 904.0 |

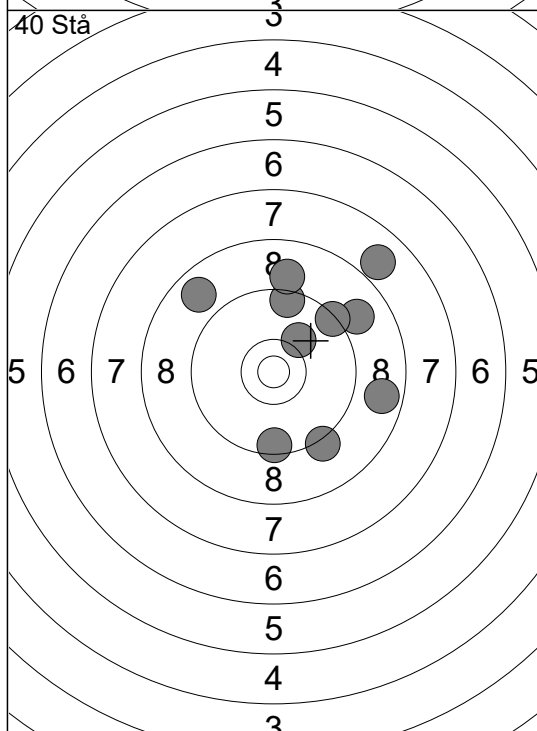

| | |
|-------|-------|
| 21: | 9.2 |
| 22: | 9.5 |
| 23: | 7.9 |
| 24: | 9.5 |
| 25: | 10.1 |
| 26: | 9.0 |
| 27: | 8.8 |
| 28: | 8.7 |
| 29: | 9.4 |
| 30: | 9.0 |
| Serie | 87.0 |
| Total | 991.0 |

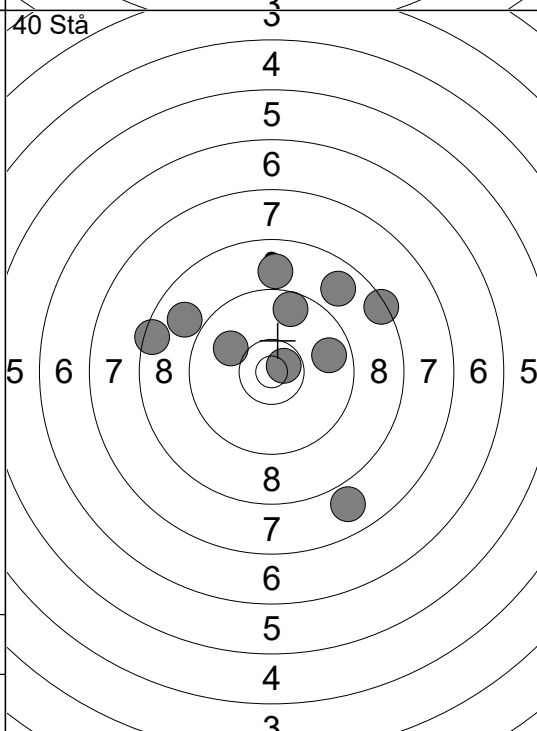

| | |
|-------|--------|
| 31: | 8.8 |
| 32: | 10.0 |
| 33: | 8.5 |
| 34: | 8.4 |
| 35: | 9.6 |
| 36: | 8.9 |
| 37: | 9.8 |
| 38: | 8.9 |
| 39: | 10.7x |
| 40: | 7.9 |
| Serie | 85.0 |
| Total | 1076.0 |

| | | | |
|-------------|--|--|--|
| Granngården | | | |
|-------------|--|--|--|

| | | | |
|------------|---------------------|------------------|--|
| 05.05.2018 | Trolltåffen/GP 2018 | Trollhättans SKF | |
|------------|---------------------|------------------|--|

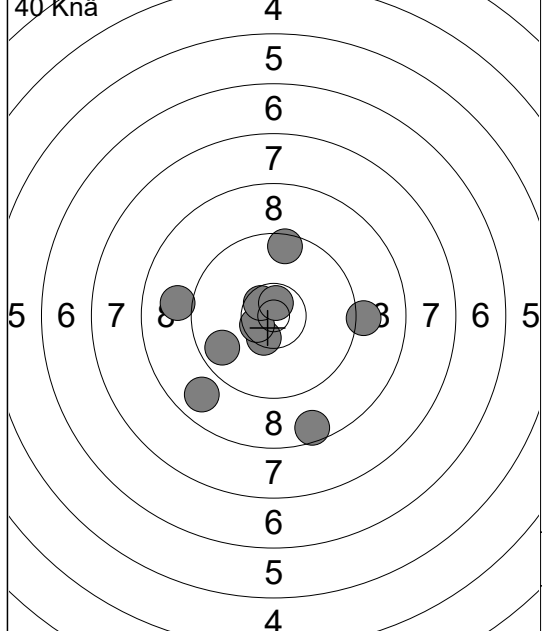

| | |
|------------|---------|
| 1: | 9.7 ↙ |
| 2: | 8.8 ↙ |
| 3: | 10.5x ↘ |
| 4: | 8.6 ↘ |
| 5: | 10.6x ↘ |
| 6: | 9.0 ← |
| 7: | 9.1 → |
| 8: | 10.6x ↘ |
| 9: | 9.5 ↑ |
| 10: | 10.7x ↗ |
| Serie 92.0 | |
| Total 92.0 | |

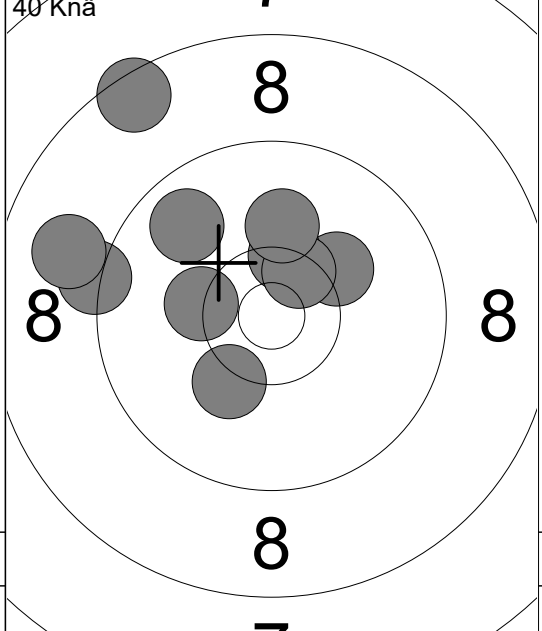

| | |
|-------------|---------|
| 11: | 8.5 ↖ |
| 12: | 10.2 ↗ |
| 13: | 10.2 ↘ |
| 14: | 10.4x ↗ |
| 15: | 9.2 ← |
| 16: | 8.9 ← |
| 17: | 10.5x ↗ |
| 18: | 10.3 ← |
| 19: | 10.1 ↑ |
| 20: | 9.8 ↖ |
| Serie 94.0 | |
| Total 186.0 | |

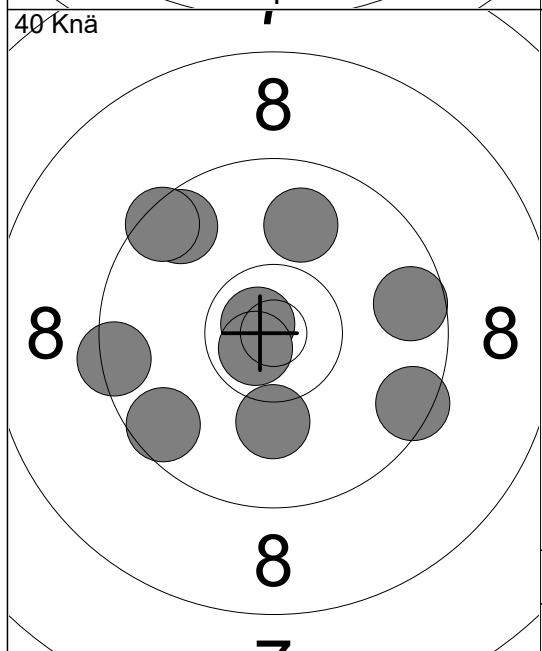

| | |
|-------------|---------|
| 21: | 9.6 ↙ |
| 22: | 10.8x ↘ |
| 23: | 9.6 ↖ |
| 24: | 9.9 ↑ |
| 25: | 10.1 ↘ |
| 26: | 9.5 → |
| 27: | 9.4 ← |
| 28: | 10.7x ↘ |
| 29: | 9.5 ↖ |
| 30: | 9.6 → |
| Serie 93.0 | |
| Total 279.0 | |

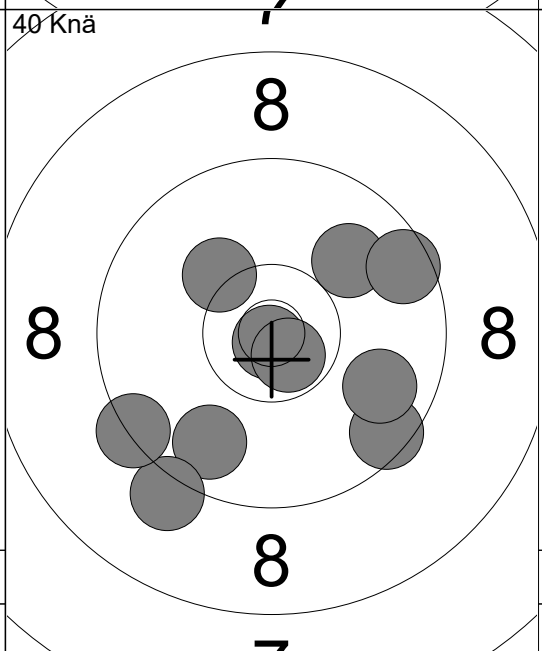

| | |
|-------------|---------|
| 31: | 10.2 ↖ |
| 32: | 9.8 ↘ |
| 33: | 10.9x ↘ |
| 34: | 9.1 ↘ |
| 35: | 9.5 ↘ |
| 36: | 9.4 ↙ |
| 37: | 10.0 ↗ |
| 38: | 10.7x ↘ |
| 39: | 9.6 → |
| 40: | 9.8 → |
| Serie 94.0 | |
| Total 373.0 | |

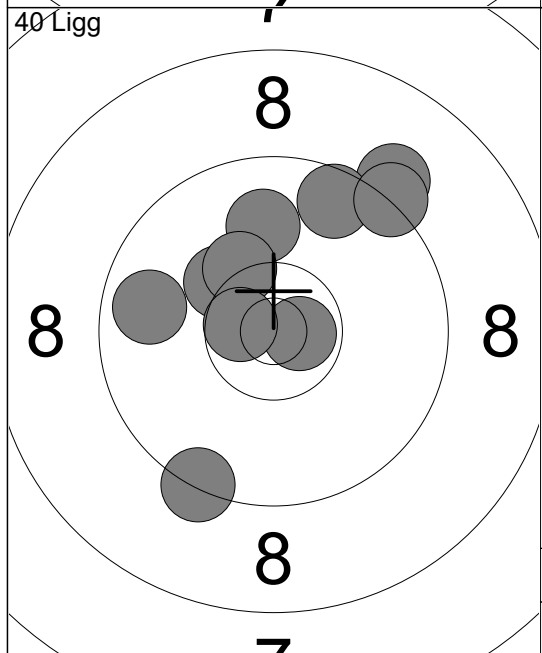

| | |
|-------------|---------|
| 1: | 9.3 ↘ |
| 2: | 9.1 ↗ |
| 3: | 10.7x → |
| 4: | 9.8 ← |
| 5: | 10.3 ↖ |
| 6: | 10.0 ↑ |
| 7: | 9.6 ↗ |
| 8: | 10.3 ↖ |
| 9: | 10.6x ↘ |
| 10: | 9.3 ↗ |
| Serie 95.0 | |
| Total 468.0 | |

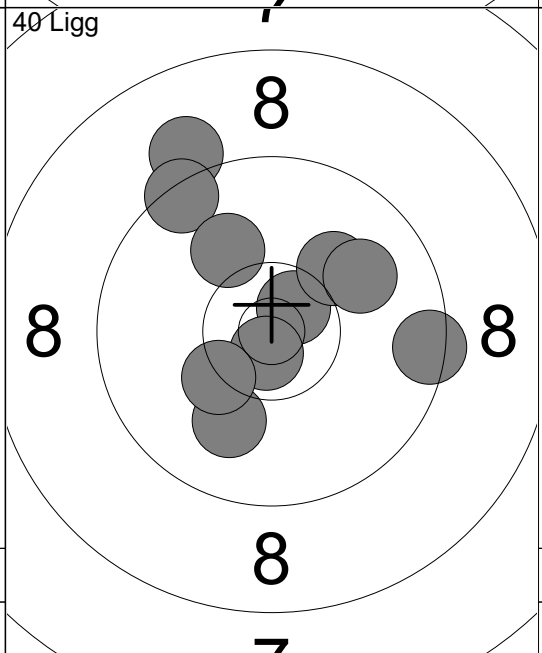

| | |
|-------------|---------|
| 11: | 9.1 ↖ |
| 12: | 9.5 → |
| 13: | 10.6x ↗ |
| 14: | 10.1 ↗ |
| 15: | 9.4 ↖ |
| 16: | 10.1 ↖ |
| 17: | 10.7x ↘ |
| 18: | 10.0 ↘ |
| 19: | 10.0 ↗ |
| 20: | 10.3 ↘ |
| Serie 97.0 | |
| Total 565.0 | |

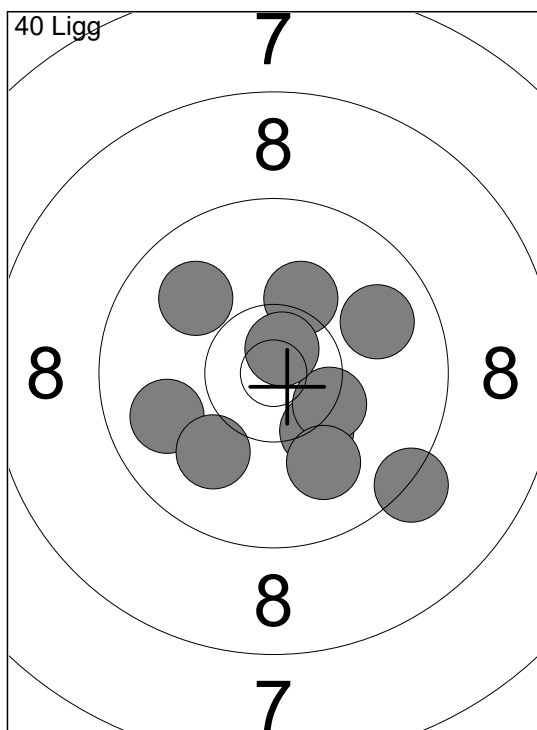

| | |
|-------|---------|
| 21: | 10.3 ↘ |
| 22: | 10.2 ↗ |
| 23: | 9.9 → |
| 24: | 10.3x ↘ |
| 25: | 9.9 ← |
| 26: | 10.7x ↗ |
| 27: | 9.9 ↖ |
| 28: | 9.3 ↘ |
| 29: | 10.0 ↙ |
| 30: | 10.0 ↘ |
| Serie | 96.0 |
| Total | 661.0 |

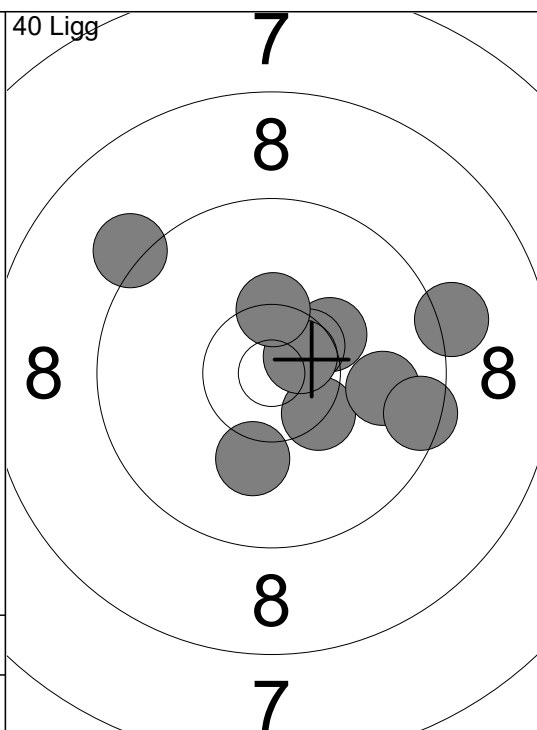

| | |
|-------|---------|
| 31: | 10.4x ↘ |
| 32: | 10.3x ↗ |
| 33: | 10.5x ↗ |
| 34: | 9.2 → |
| 35: | 10.6x ↗ |
| 36: | 9.9 → |
| 37: | 9.5 → |
| 38: | 10.4x ↗ |
| 39: | 10.1 ↓ |
| 40: | 9.2 ↖ |
| Serie | 96.0 |
| Total | 757.0 |

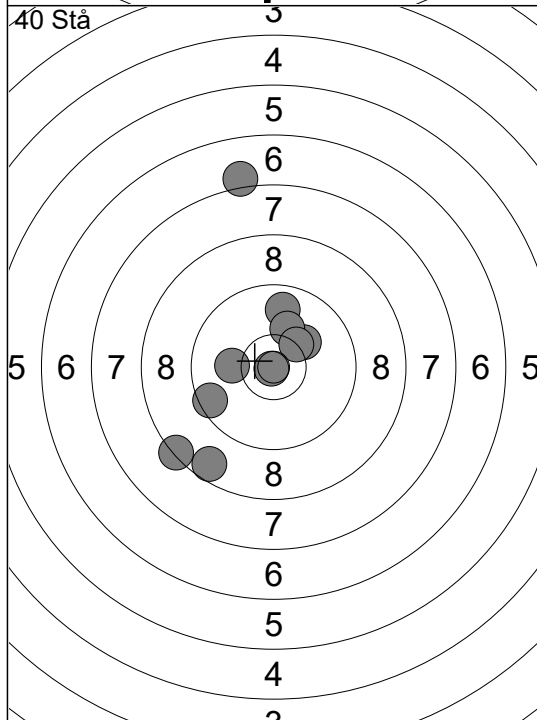

| | |
|-------|---------|
| 1: | 9.5 ← |
| 2: | 7.1 ↑ |
| 3: | 8.4 ↙ |
| 4: | 10.2 ↗ |
| 5: | 9.8 ↑ |
| 6: | 8.6 ↙ |
| 7: | 10.1 ↑ |
| 8: | 10.1 ← |
| 9: | 10.3x ↗ |
| 10: | 10.9x ↘ |
| Serie | 91.0 |
| Total | 848.0 |

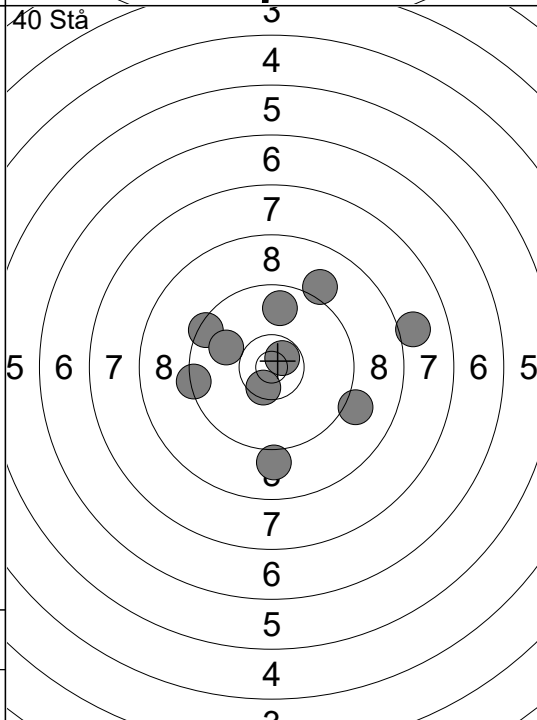

| | |
|-------|---------|
| 11: | 9.4 ← |
| 12: | 9.1 ↗ |
| 13: | 9.4 ↖ |
| 14: | 10.0 ↙ |
| 15: | 9.8 ↑ |
| 16: | 10.7x ↗ |
| 17: | 10.5x ↙ |
| 18: | 9.0 ↓ |
| 19: | 8.0 → |
| 20: | 9.1 ↘ |
| Serie | 92.0 |
| Total | 940.0 |

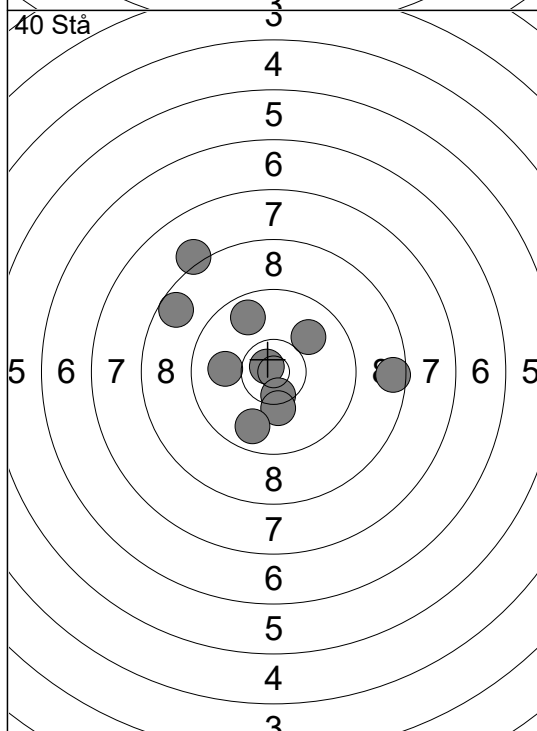

| | |
|-------|---------|
| 21: | 10.8x ↘ |
| 22: | 8.6 ↖ |
| 23: | 8.1 ↖ |
| 24: | 8.6 → |
| 25: | 9.7 ↖ |
| 26: | 10.5x ↙ |
| 27: | 10.2 ↓ |
| 28: | 9.8 ↙ |
| 29: | 10.0 ← |
| 30: | 10.0 ↗ |
| Serie | 92.0 |
| Total | 1032.0 |

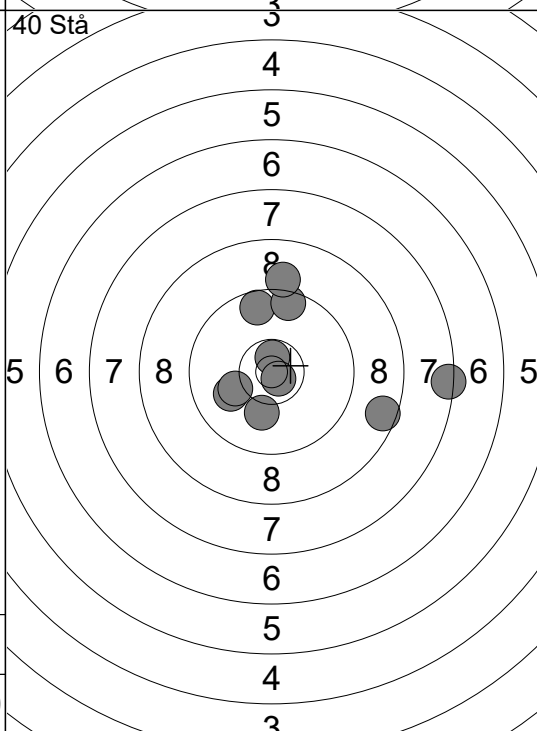

| | |
|-------|---------|
| 31: | 9.6 ↑ |
| 32: | 9.5 ↑ |
| 33: | 7.4 → |
| 34: | 10.0 ↙ |
| 35: | 10.1 ↓ |
| 36: | 10.2 ↙ |
| 37: | 10.7x ↗ |
| 38: | 9.1 ↑ |
| 39: | 10.8x ↘ |
| 40: | 8.6 ↘ |
| Serie | 92.0 |
| Total | 1124.0 |

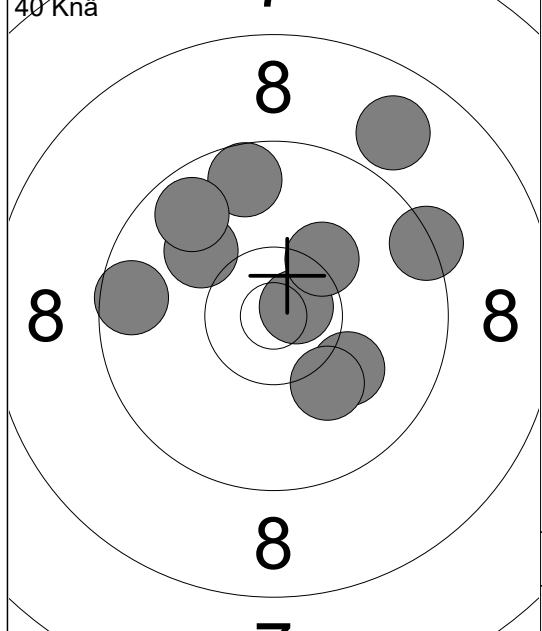

| | | |
|-------|------|------|
| 1: | 9.6 | ← |
| 2: | 9.6 | ↑ |
| 3: | 10.7 | x→ |
| 4: | 10.0 | ↖ |
| 5: | 8.9 | ↗ |
| 6: | 10.1 | ↘ |
| 7: | 10.2 | ↗ |
| 8: | 9.7 | ↖ |
| 9: | 9.4 | → |
| 10: | 10.1 | ↘ |
| Serie | | 94.0 |
| Total | | 94.0 |

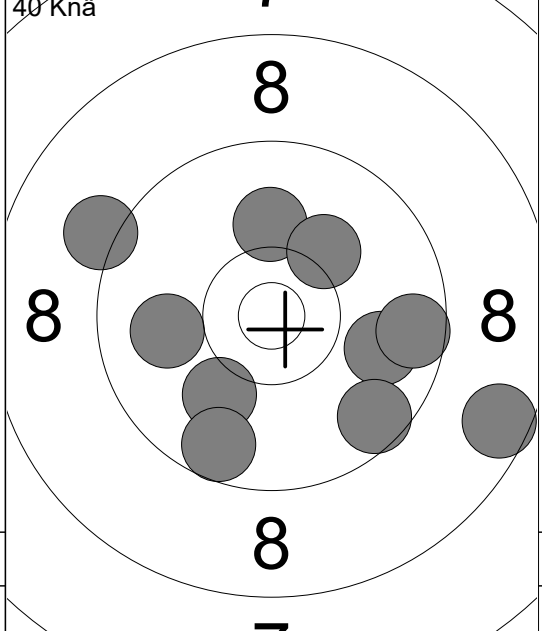

| | | |
|-------|------|-------|
| 11: | 9.9 | → |
| 12: | 10.1 | ↑ |
| 13: | 9.2 | ↖ |
| 14: | 8.6 | → |
| 15: | 10.2 | ↗ |
| 16: | 10.1 | ↘ |
| 17: | 9.6 | ↘ |
| 18: | 9.6 | → |
| 19: | 9.6 | ↘ |
| 20: | 10.0 | ← |
| Serie | | 93.0 |
| Total | | 187.0 |

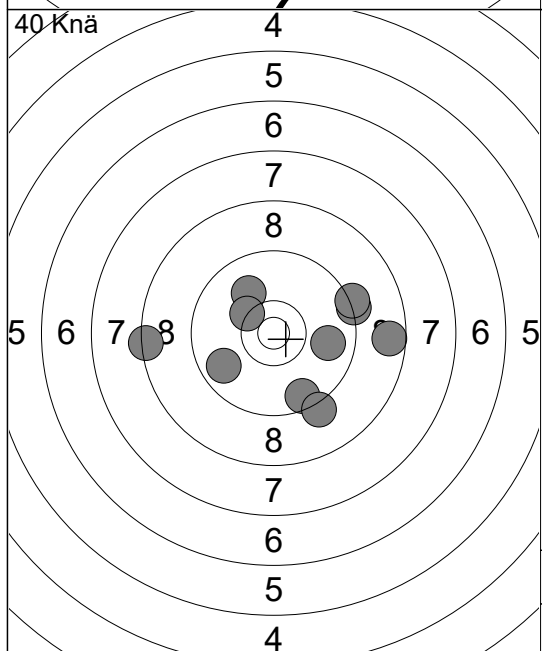

| | | |
|-------|------|-------|
| 21: | 10.0 | ↖ |
| 22: | 9.6 | ↘ |
| 23: | 9.3 | → |
| 24: | 8.4 | ← |
| 25: | 8.6 | → |
| 26: | 9.8 | → |
| 27: | 9.2 | → |
| 28: | 10.3 | ↖ |
| 29: | 9.8 | ↖ |
| 30: | 9.2 | ↘ |
| Serie | | 90.0 |
| Total | | 277.0 |

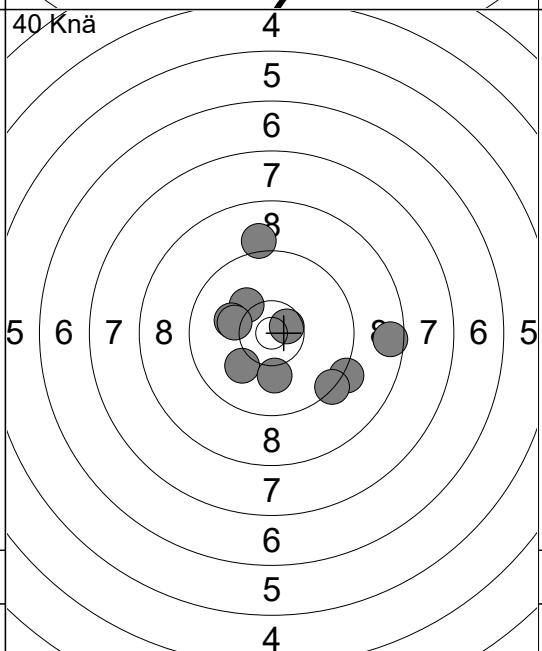

| | | |
|-------|------|-------|
| 31: | 8.6 | → |
| 32: | 10.1 | ↘ |
| 33: | 9.2 | ↘ |
| 34: | 10.2 | ↖ |
| 35: | 10.1 | ← |
| 36: | 10.6 | x→ |
| 37: | 10.1 | ↘ |
| 38: | 10.2 | ← |
| 39: | 9.3 | ↘ |
| 40: | 9.1 | ↑ |
| Serie | | 95.0 |
| Total | | 372.0 |

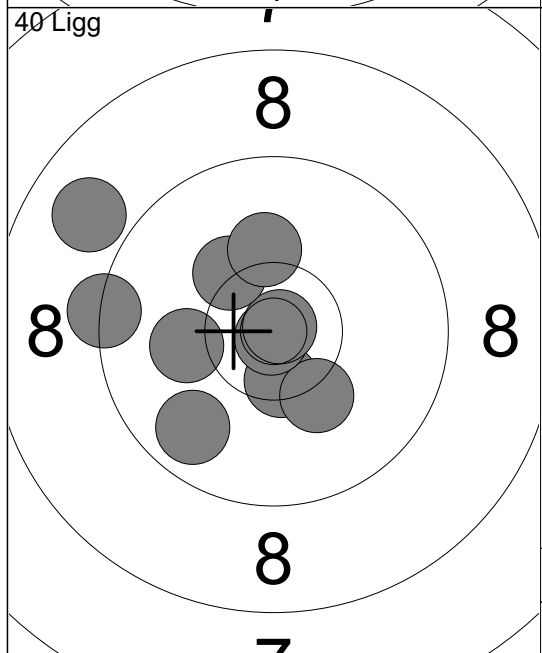

| | | |
|-------|------|-------|
| 1: | 10.1 | ← |
| 2: | 10.5 | x↘ |
| 3: | 10.2 | ↘ |
| 4: | 9.3 | ← |
| 5: | 10.9 | x↘ |
| 6: | 10.9 | x→ |
| 7: | 10.3 | ↖ |
| 8: | 9.8 | ↘ |
| 9: | 10.2 | ↑ |
| 10: | 8.9 | ↖ |
| Serie | | 96.0 |
| Total | | 468.0 |

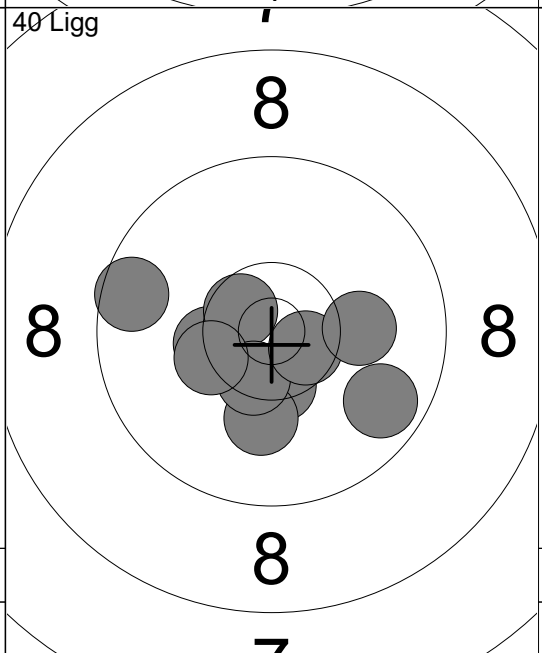

| | | |
|-------|------|-------|
| 11: | 10.4 | x↖ |
| 12: | 10.4 | x↘ |
| 13: | 9.6 | ← |
| 14: | 10.1 | ↘ |
| 15: | 10.6 | x↖ |
| 16: | 10.5 | x↘ |
| 17: | 10.6 | x→ |
| 18: | 10.3 | x↖ |
| 19: | 9.7 | ↘ |
| 20: | 10.1 | → |
| Serie | | 98.0 |
| Total | | 566.0 |

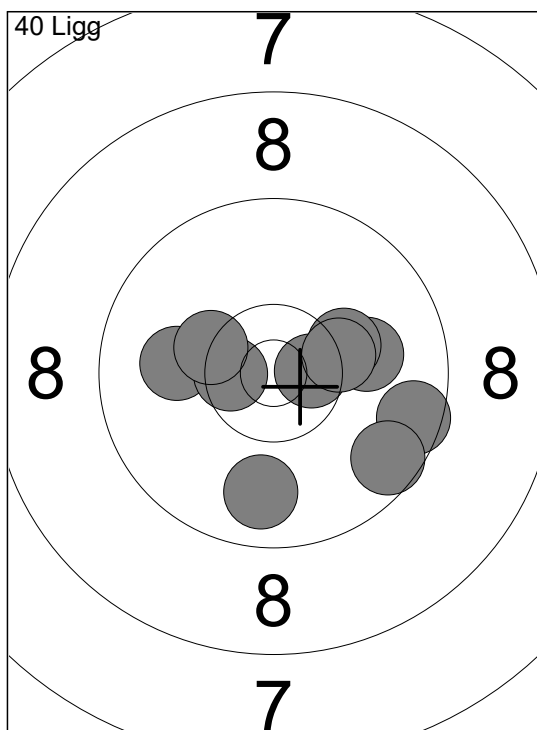

| | | |
|-------|------|-------|
| 21: | 9.6 | → |
| 22: | 10.0 | ← |
| 23: | 10.5 | ✕ |
| 24: | 10.1 | → |
| 25: | 9.8 | ↓ |
| 26: | 10.6 | → |
| 27: | 9.6 | → |
| 28: | 10.3 | ✕ |
| 29: | 10.2 | → |
| 30: | 10.3 | → |
| Serie | | 97.0 |
| Total | | 663.0 |

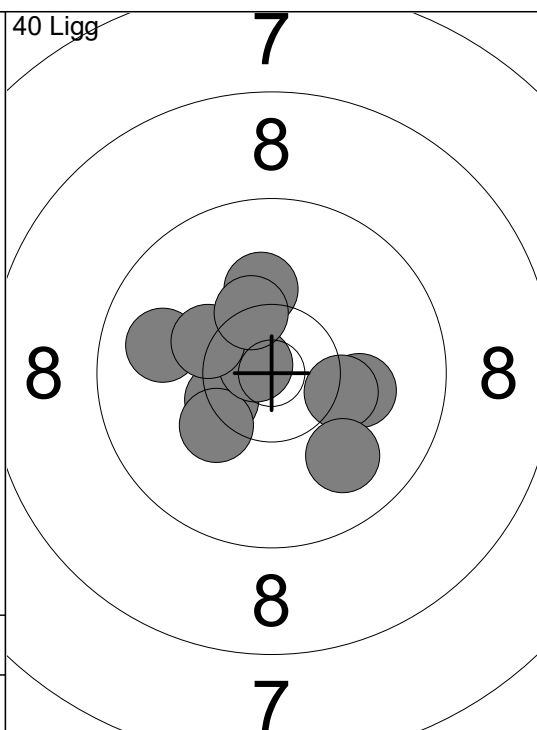

| | | |
|-------|------|-------|
| 31: | 10.4 | ✕ |
| 32: | 10.2 | ↘ |
| 33: | 10.8 | ✕ |
| 34: | 10.1 | ↑ |
| 35: | 10.1 | → |
| 36: | 9.9 | ← |
| 37: | 10.3 | ↖ |
| 38: | 10.3 | ↗ |
| 39: | 10.3 | → |
| 40: | 9.9 | ↘ |
| Serie | | 98.0 |
| Total | | 761.0 |

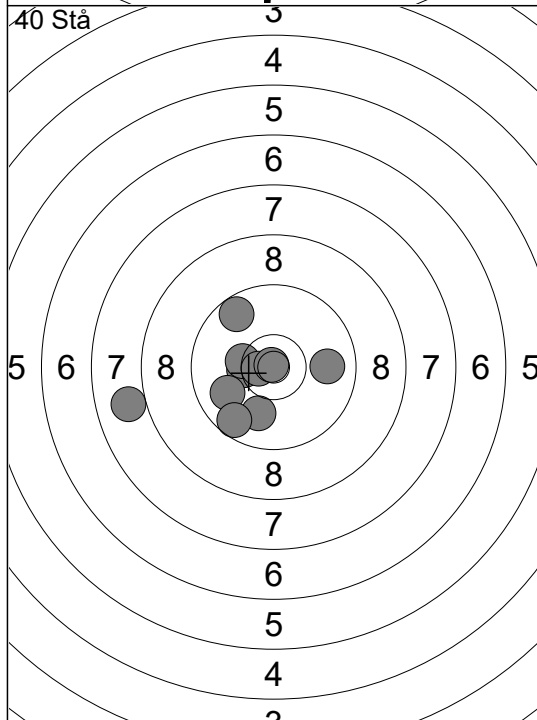

| | | |
|-------|------|-------|
| 1: | 10.0 | ↓ |
| 2: | 10.4 | ✕ |
| 3: | 9.9 | → |
| 4: | 7.9 | ← |
| 5: | 9.7 | ↗ |
| 6: | 9.9 | ← |
| 7: | 10.3 | ✕ |
| 8: | 9.6 | ↓ |
| 9: | 10.6 | ✕ |
| 10: | 10.9 | ✕ |
| Serie | | 93.0 |
| Total | | 854.0 |

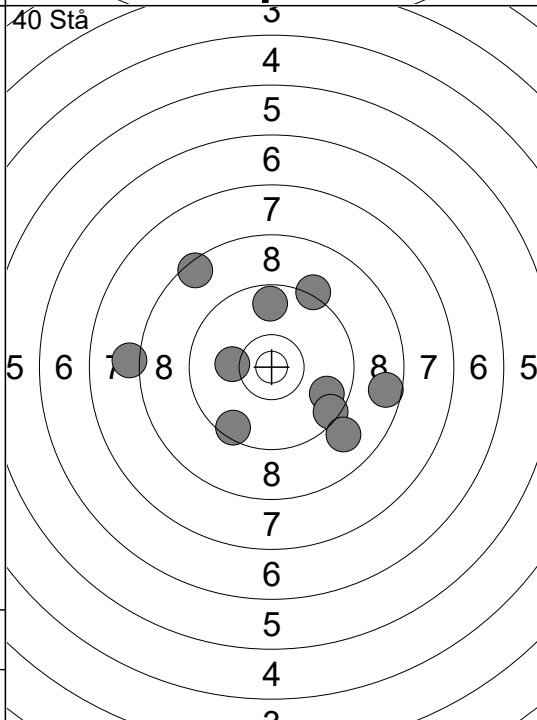

| | | |
|-------|------|-------|
| 11: | 9.2 | ↗ |
| 12: | 8.5 | ↖ |
| 13: | 8.1 | ← |
| 14: | 9.7 | ↑ |
| 15: | 9.7 | → |
| 16: | 9.5 | ↘ |
| 17: | 9.5 | ↘ |
| 18: | 10.2 | ← |
| 19: | 8.6 | → |
| 20: | 9.0 | ↘ |
| Serie | | 88.0 |
| Total | | 942.0 |

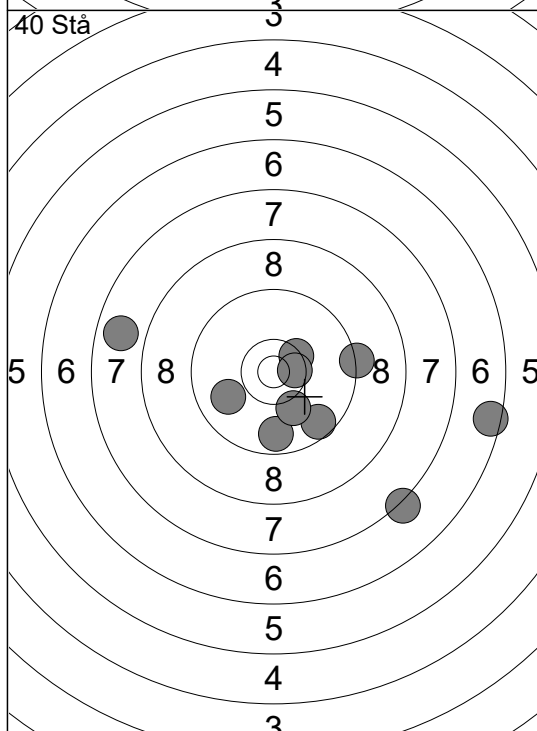

| | | |
|-------|------|--------|
| 21: | 10.4 | ↗ |
| 22: | 10.5 | → |
| 23: | 9.3 | → |
| 24: | 9.9 | ← |
| 25: | 7.8 | ← |
| 26: | 6.5 | → |
| 27: | 7.2 | ↘ |
| 28: | 9.7 | ↓ |
| 29: | 9.6 | ↘ |
| 30: | 10.1 | ↓ |
| Serie | | 86.0 |
| Total | | 1028.0 |

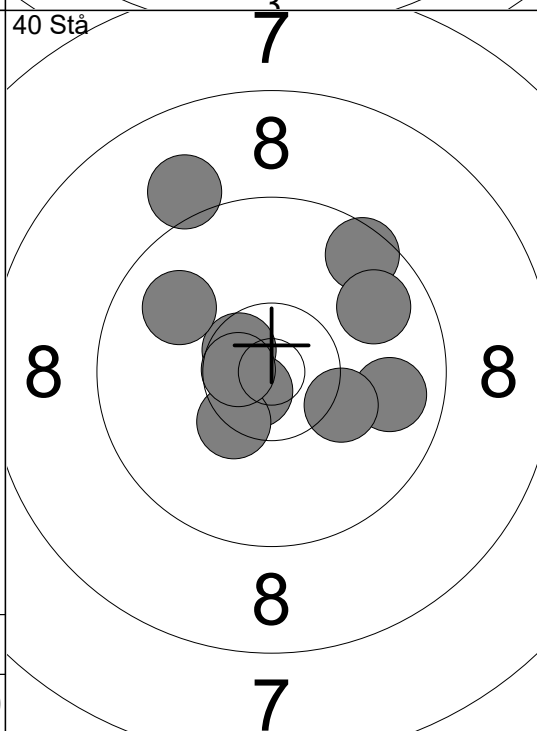

| | | |
|-------|------|--------|
| 31: | 9.8 | → |
| 32: | 9.5 | ↗ |
| 33: | 10.7 | ✕ |
| 34: | 10.6 | ✕ |
| 35: | 9.8 | ↗ |
| 36: | 10.4 | ✕ |
| 37: | 9.9 | ↖ |
| 38: | 10.6 | ✕ |
| 39: | 10.2 | → |
| 40: | 9.1 | ↖ |
| Serie | | 95.0 |
| Total | | 1123.0 |

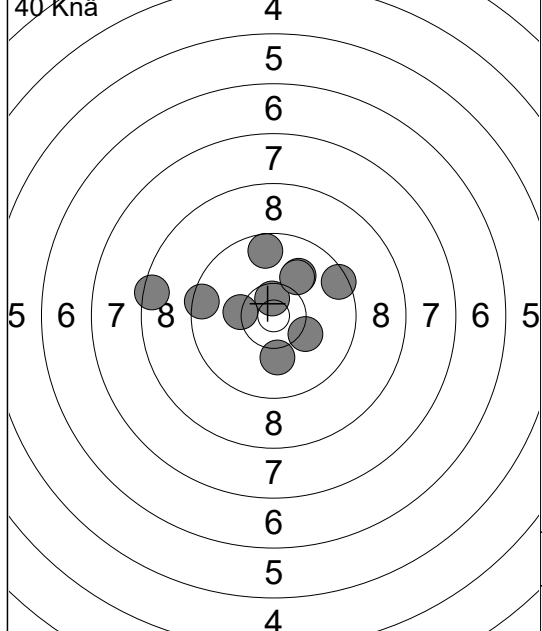

| | |
|------------|--------|
| 1: | 9.5 ← |
| 2: | 10.0 ↗ |
| 3: | 10.1 ↓ |
| 4: | 10.6x↑ |
| 5: | 9.5 → |
| 6: | 10.0 ↗ |
| 7: | 10.2 → |
| 8: | 9.6 ↑ |
| 9: | 10.3 ← |
| 10: | 8.5 ← |
| Serie 95.0 | |
| Total 95.0 | |

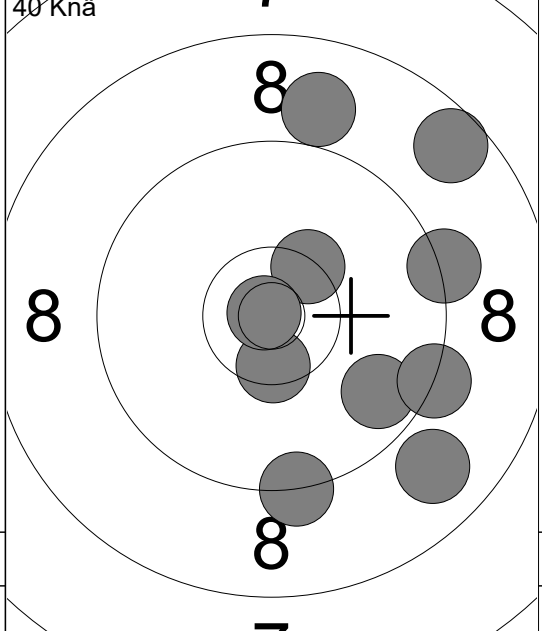

| | |
|-------------|--------|
| 11: | 8.9 ↘ |
| 12: | 10.5x↓ |
| 13: | 10.4x↗ |
| 14: | 10.9x↖ |
| 15: | 8.6 ↗ |
| 16: | 9.3 → |
| 17: | 9.0 ↑ |
| 18: | 9.3 ↓ |
| 19: | 9.7 → |
| 20: | 9.3 → |
| Serie 91.0 | |
| Total 186.0 | |

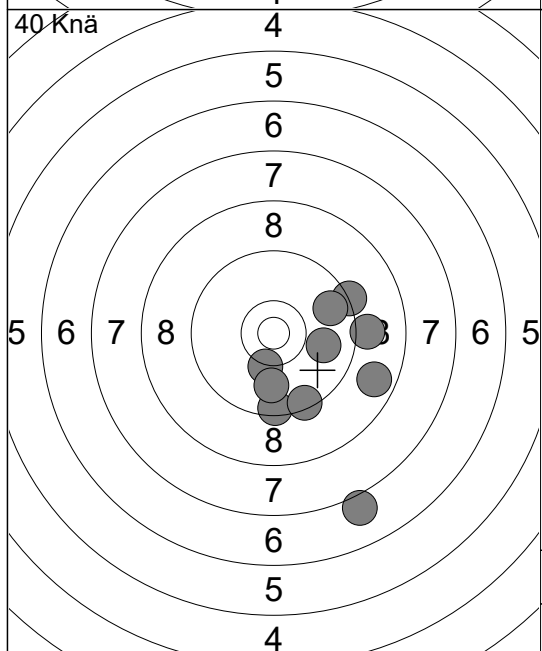

| | |
|-------------|--------|
| 21: | 9.3 → |
| 22: | 10.3 ↓ |
| 23: | 9.9 → |
| 24: | 7.0 ↓ |
| 25: | 9.5 ↓ |
| 26: | 9.4 ↓ |
| 27: | 8.7 → |
| 28: | 9.9 ↓ |
| 29: | 9.7 → |
| 30: | 9.1 → |
| Serie 88.0 | |
| Total 274.0 | |

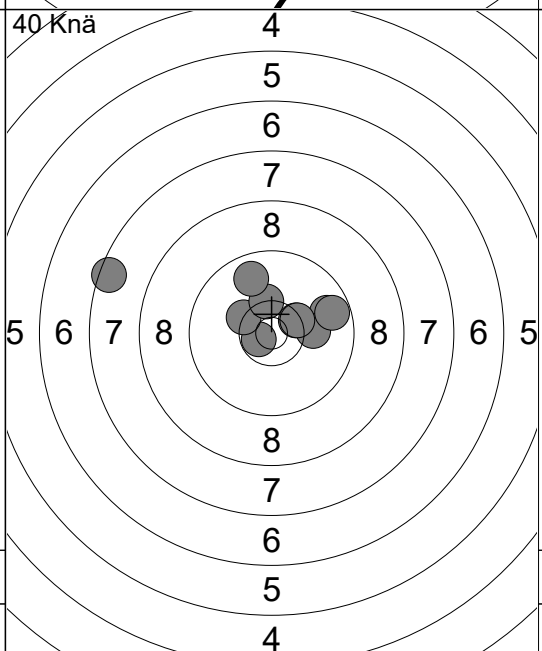

| | |
|-------------|--------|
| 31: | 9.8 → |
| 32: | 10.1 → |
| 33: | 10.7x↖ |
| 34: | 10.4x↗ |
| 35: | 10.3x↖ |
| 36: | 10.3x↑ |
| 37: | 9.7 → |
| 38: | 9.8 ↑ |
| 39: | 10.4x↗ |
| 40: | 7.5 ← |
| Serie 94.0 | |
| Total 368.0 | |

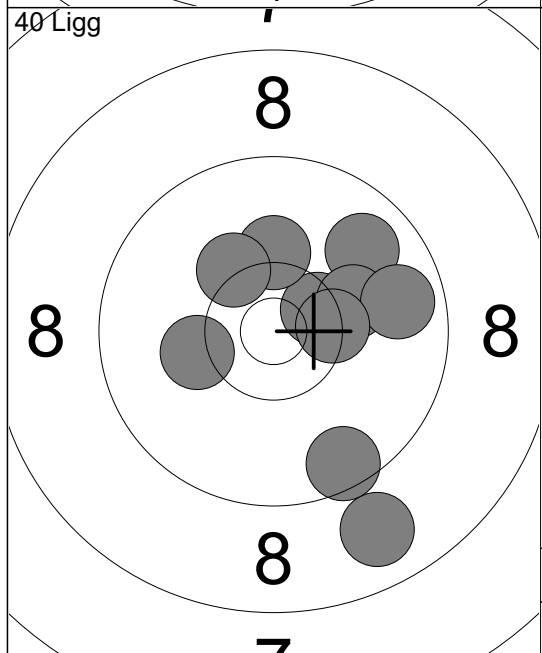

| | |
|-------------|--------|
| 1: | 9.8 ↗ |
| 2: | 10.5x↗ |
| 3: | 10.2 ↑ |
| 4: | 10.2 → |
| 5: | 10.3 ↖ |
| 6: | 9.7 → |
| 7: | 10.4x↗ |
| 8: | 8.8 ↓ |
| 9: | 10.2 ← |
| 10: | 9.5 ↓ |
| Serie 95.0 | |
| Total 463.0 | |

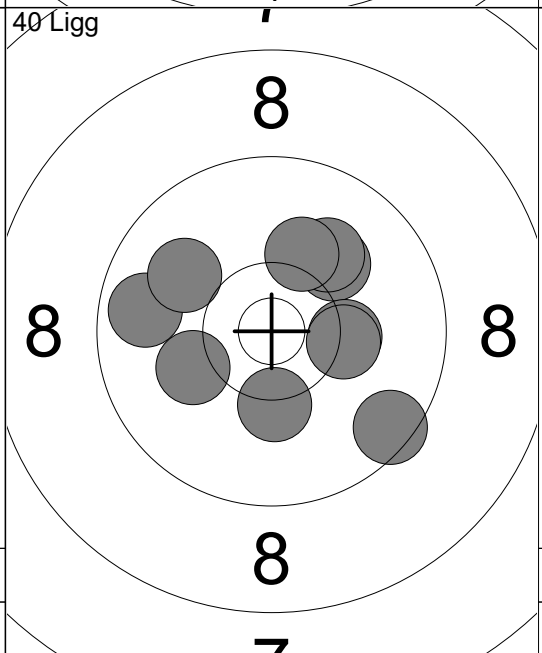

| | |
|-------------|--------|
| 11: | 9.7 ← |
| 12: | 10.3 ↓ |
| 13: | 10.1 ↗ |
| 14: | 10.1 ↗ |
| 15: | 10.0 ↖ |
| 16: | 10.2 ↑ |
| 17: | 9.5 ↓ |
| 18: | 10.1 ← |
| 19: | 10.3 → |
| 20: | 10.3 → |
| Serie 98.0 | |
| Total 561.0 | |

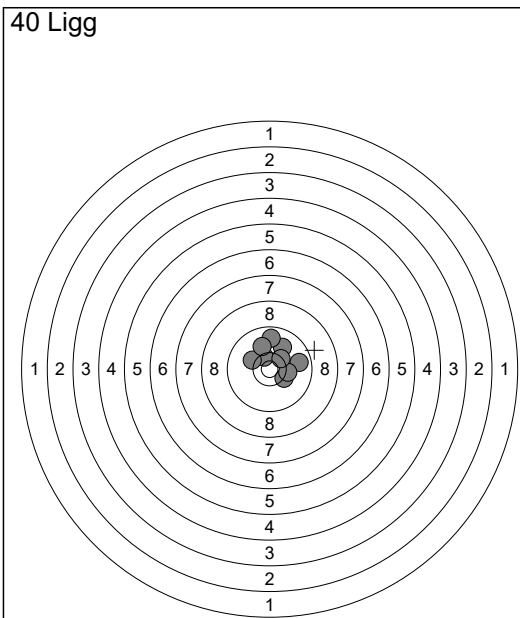

| | | |
|-----|------|---|
| 21: | 9.8 | → |
| 22: | 10.4 | ↖ |
| 23: | 10.3 | ↘ |
| 24: | 0.0 | → |
| 25: | 10.0 | ↗ |
| 26: | 10.2 | ↖ |
| 27: | 9.7 | ↑ |
| 28: | 10.2 | → |
| 29: | 10.3 | ↗ |
| 30: | 10.0 | ↖ |

| | |
|-------|-------|
| Serie | 88.0 |
| Total | 649.0 |

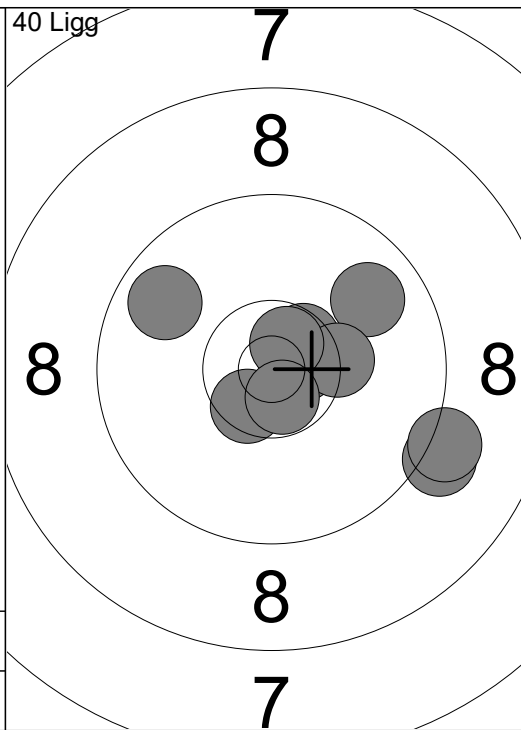

| | | |
|-----|------|---|
| 31: | 9.2 | ↘ |
| 32: | 10.7 | ↗ |
| 33: | 10.5 | ↘ |
| 34: | 9.8 | ↖ |
| 35: | 9.8 | ↗ |
| 36: | 10.5 | ↗ |
| 37: | 10.3 | ↗ |
| 38: | 10.7 | ↗ |
| 39: | 9.2 | ↘ |
| 40: | 10.7 | ↘ |

| | |
|-------|-------|
| Serie | 96.0 |
| Total | 745.0 |

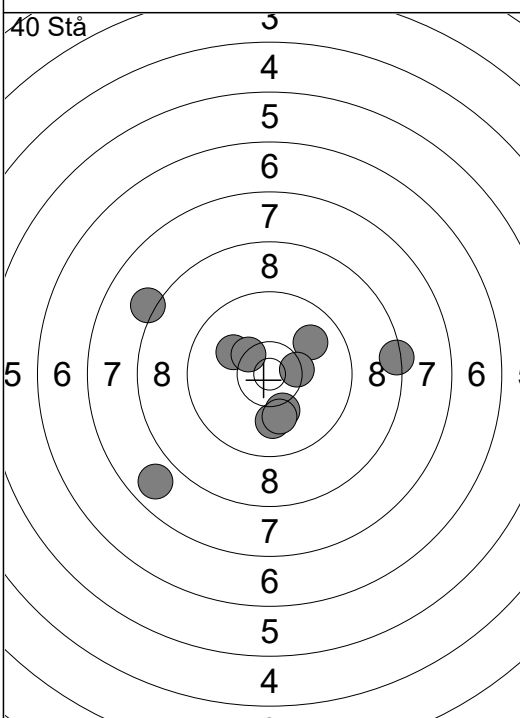

| | | |
|-----|------|---|
| 1: | 10.0 | ↓ |
| 2: | 10.1 | ↖ |
| 3: | 9.9 | ↗ |
| 4: | 8.4 | → |
| 5: | 8.2 | ↖ |
| 6: | 10.4 | ↖ |
| 7: | 10.2 | ↓ |
| 8: | 7.8 | ↖ |
| 9: | 10.4 | ↗ |
| 10: | 10.1 | ↓ |

| | |
|-------|-------|
| Serie | 92.0 |
| Total | 837.0 |

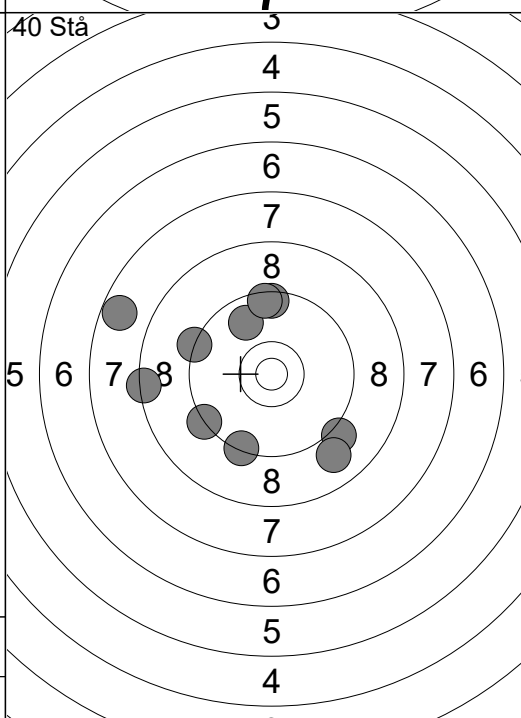

| | | |
|-----|-----|---|
| 11: | 9.1 | ↘ |
| 12: | 8.9 | ↘ |
| 13: | 9.3 | ↓ |
| 14: | 7.7 | ↖ |
| 15: | 9.5 | ↑ |
| 16: | 9.3 | ↖ |
| 17: | 9.8 | ↗ |
| 18: | 9.5 | ↑ |
| 19: | 9.3 | ↖ |
| 20: | 8.4 | ← |

| | |
|-------|-------|
| Serie | 86.0 |
| Total | 923.0 |

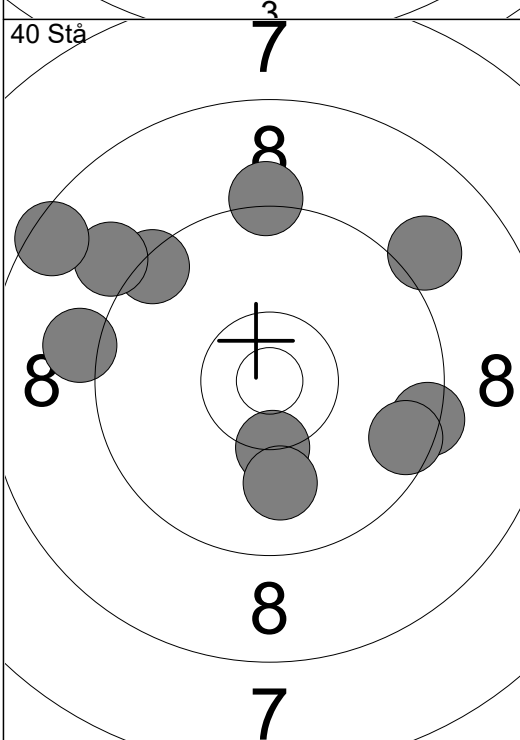

| | | |
|-----|------|---|
| 21: | 10.3 | ↘ |
| 22: | 10.0 | ↓ |
| 23: | 9.1 | ↗ |
| 24: | 9.1 | ← |
| 25: | 9.2 | ↑ |
| 26: | 9.4 | → |
| 27: | 9.4 | ↖ |
| 28: | 9.1 | ↖ |
| 29: | 8.5 | ↖ |
| 30: | 9.6 | → |

| | |
|-------|--------|
| Serie | 91.0 |
| Total | 1014.0 |

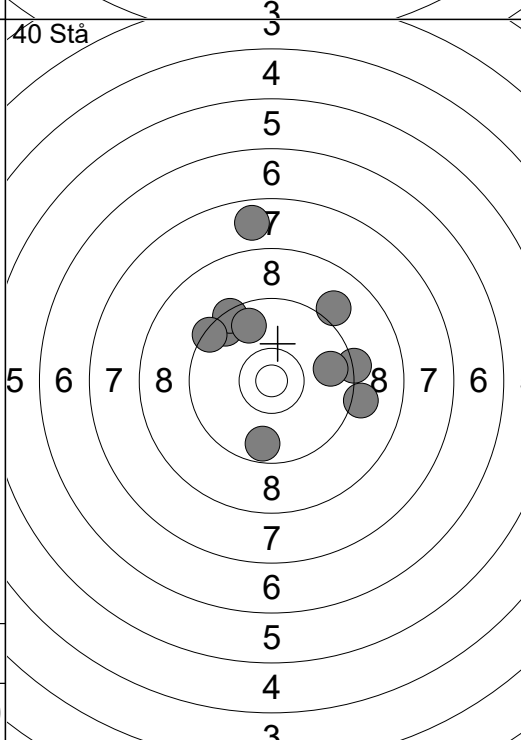

| | | |
|-----|-----|---|
| 31: | 9.6 | ↖ |
| 32: | 9.0 | ↗ |
| 33: | 9.4 | ↖ |
| 34: | 9.8 | ↗ |
| 35: | 9.4 | ↖ |
| 36: | 9.3 | → |
| 37: | 9.7 | → |
| 38: | 7.8 | ↑ |
| 39: | 9.7 | ↓ |
| 40: | 9.1 | → |

| | |
|-------|--------|
| Serie | 88.0 |
| Total | 1102.0 |

| | | |
|---------------|---------------|---------------|
| <p>40 Knä</p> | <p>40 Knä</p> | <p>40 Knä</p> |
| Serie 83.0 | Serie 87.0 | Serie 89.0 |
| Total 83.0 | Total 170.0 | Total 344.0 |

| | | |
|---------------|----------------|----------------|
| <p>40 Knä</p> | <p>40 Ligg</p> | <p>40 Ligg</p> |
| Serie 85.0 | Serie 95.0 | Serie 95.0 |
| Total 255.0 | Total 439.0 | Total 534.0 |

| | | |
|----------------|----------------|----------------|
| <p>40 Ligg</p> | <p>40 Ligg</p> | <p>40 Ligg</p> |
| Serie 95.0 | Serie 95.0 | Serie 95.0 |
| Total 439.0 | Total 534.0 | Total 534.0 |

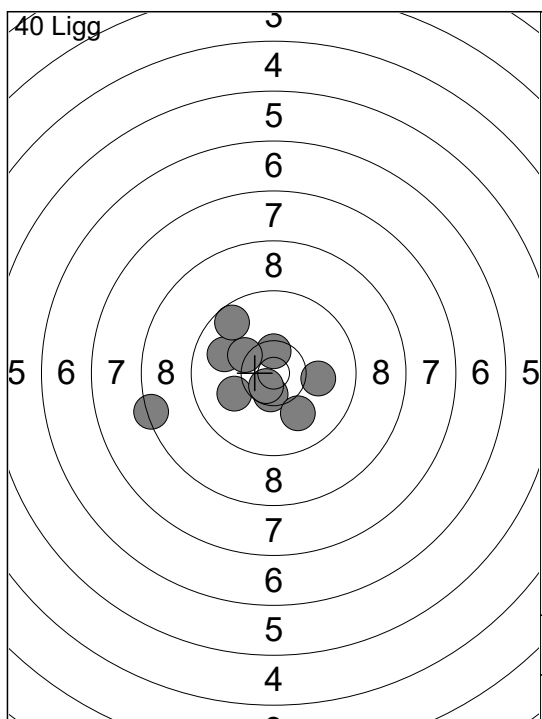

| | | |
|-------|-------|---|
| 21: | 10.5x | ↘ |
| 22: | 9.9 | ← |
| 23: | 10.5x | ↗ |
| 24: | 10.1 | ↙ |
| 25: | 10.0 | ↘ |
| 26: | 10.7x | ↘ |
| 27: | 8.4 | ← |
| 28: | 9.6 | ↗ |
| 29: | 10.3 | ↙ |
| 30: | 10.0 | → |
| Serie | 96.0 | |
| Total | 630.0 | |

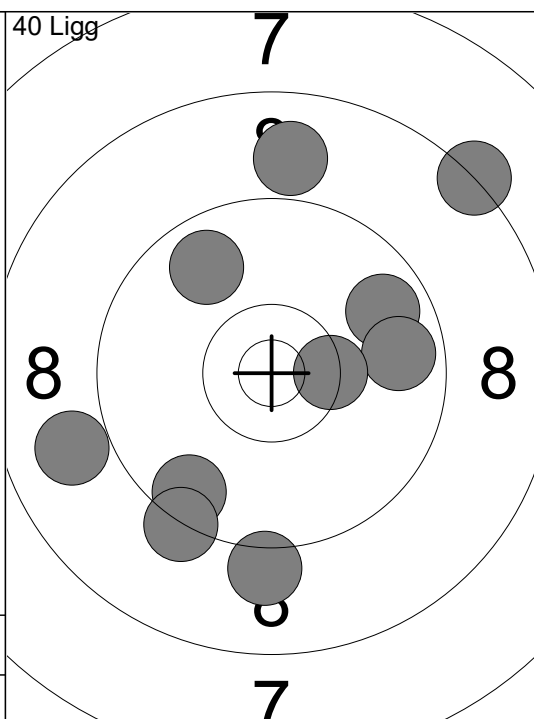

| | | |
|-------|-------|---|
| 31: | 9.6 | ↘ |
| 32: | 9.3 | ↘ |
| 33: | 8.9 | ← |
| 34: | 8.9 | ↑ |
| 35: | 8.3 | ↗ |
| 36: | 9.7 | ↗ |
| 37: | 9.8 | ↖ |
| 38: | 9.7 | → |
| 39: | 9.1 | ↓ |
| 40: | 10.4x | → |
| Serie | 88.0 | |
| Total | 718.0 | |

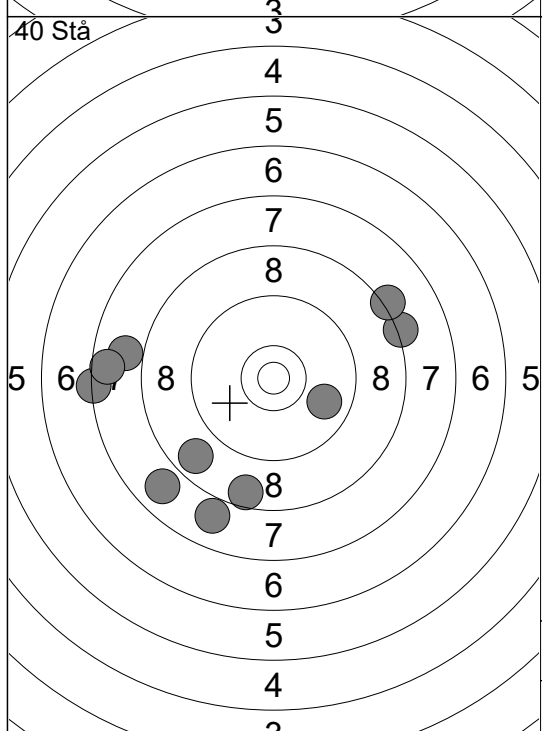

| | | |
|-------|-------|---|
| 1: | 7.3 | ← |
| 2: | 7.9 | ← |
| 3: | 7.8 | ↘ |
| 4: | 7.9 | ↘ |
| 5: | 8.6 | ↘ |
| 6: | 8.7 | ↘ |
| 7: | 7.6 | ← |
| 8: | 9.8 | → |
| 9: | 8.2 | → |
| 10: | 8.2 | ↗ |
| Serie | 76.0 | |
| Total | 794.0 | |

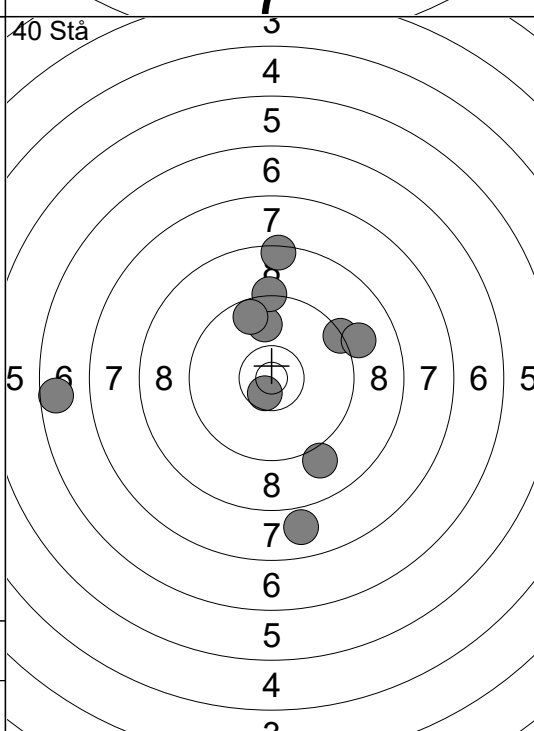

| | | |
|-------|-------|---|
| 11: | 10.6x | ↘ |
| 12: | 9.0 | ↘ |
| 13: | 9.9 | ↑ |
| 14: | 9.3 | ↗ |
| 15: | 9.1 | → |
| 16: | 9.3 | ↑ |
| 17: | 8.4 | ↑ |
| 18: | 9.6 | ↑ |
| 19: | 7.9 | ↘ |
| 20: | 6.6 | ← |
| Serie | 85.0 | |
| Total | 879.0 | |

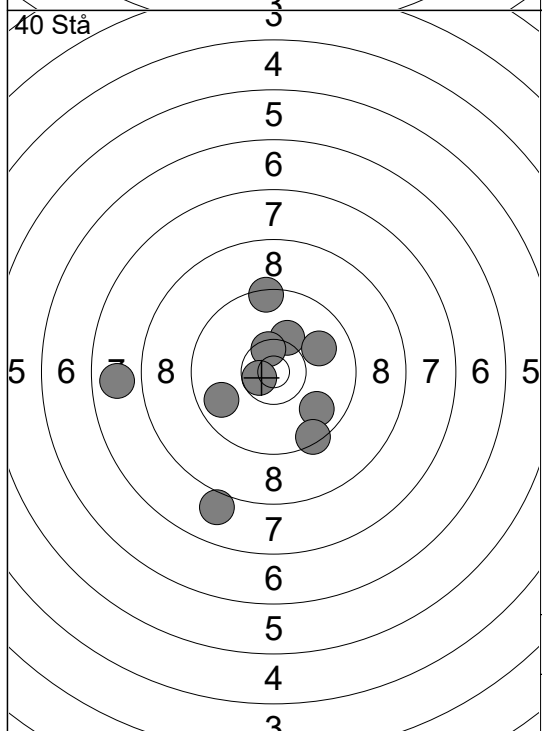

| | | |
|-------|-------|---|
| 21: | 9.8 | ↘ |
| 22: | 9.8 | ← |
| 23: | 10.2 | ↗ |
| 24: | 10.5x | ↗ |
| 25: | 9.4 | ↘ |
| 26: | 9.9 | ↗ |
| 27: | 10.6x | ↘ |
| 28: | 9.4 | ↑ |
| 29: | 7.8 | ← |
| 30: | 8.0 | ↘ |
| Serie | 90.0 | |
| Total | 969.0 | |

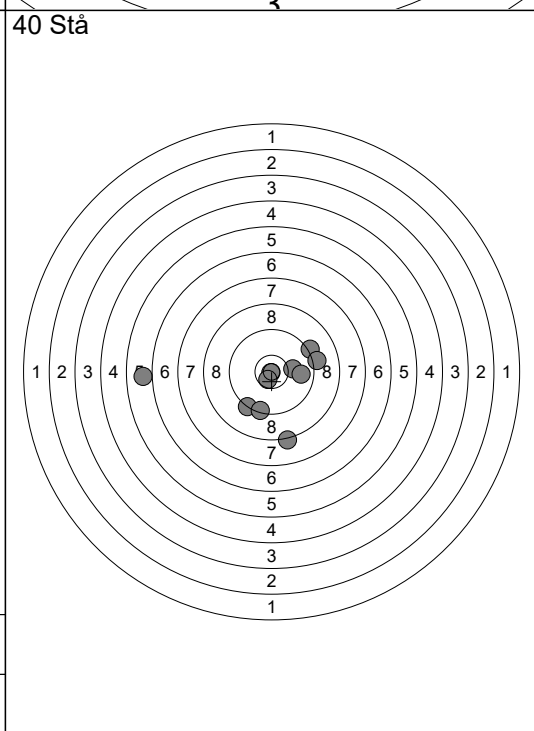

| | | |
|-------|--------|---|
| 31: | 5.9 | ← |
| 32: | 10.1 | → |
| 33: | 8.2 | ↘ |
| 34: | 10.9x | ↘ |
| 35: | 9.3 | ↘ |
| 36: | 9.2 | ↗ |
| 37: | 10.6x | ↘ |
| 38: | 9.4 | ↘ |
| 39: | 9.8 | → |
| 40: | 9.1 | → |
| Serie | 88.0 | |
| Total | 1057.0 | |

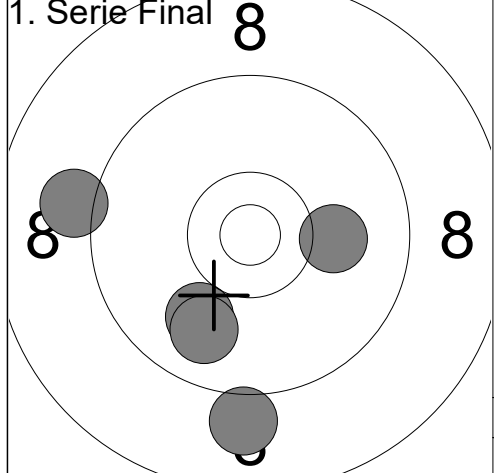

| | | |
|-------|------|------|
| 1: | 10.0 | ↘ |
| 2: | 9.0 | ↓ |
| 3: | 9.9 | ↘ |
| 4: | 9.1 | ← |
| 5: | 10.1 | → |
| Serie | | 48.1 |
| Total | | 48.1 |

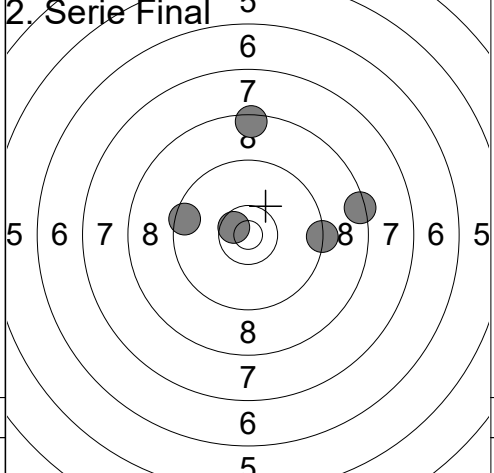

| | | |
|-------|-------|------|
| 1: | 8.4 | → |
| 2: | 8.4 | ↑ |
| 3: | 9.5 | ← |
| 4: | 10.6x | ← |
| 5: | 9.3 | → |
| Serie | | 46.2 |
| Total | | 94.3 |

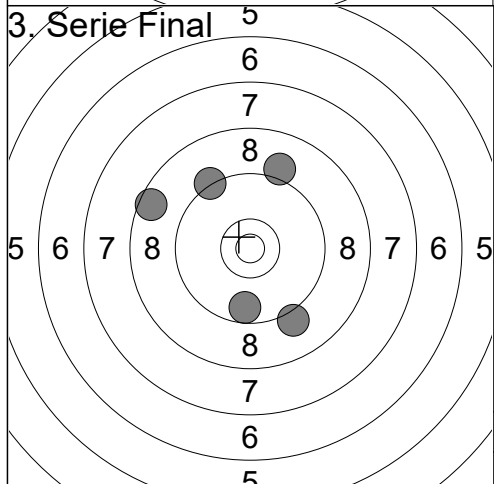

| | | |
|-------|-----|-------|
| 1: | 8.6 | ← |
| 2: | 9.1 | ↑ |
| 3: | 9.7 | ↓ |
| 4: | 9.1 | ↘ |
| 5: | 9.3 | ↗ |
| Serie | | 45.8 |
| Total | | 140.1 |

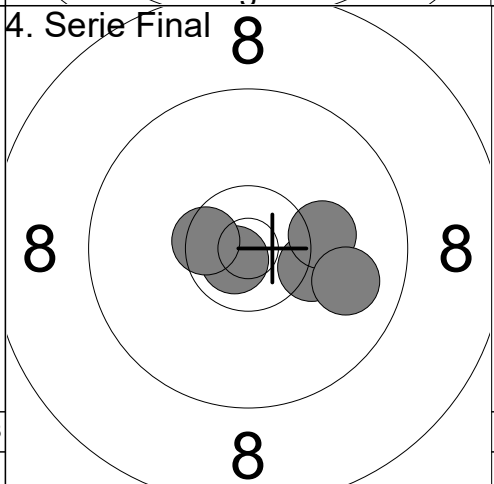

| | | |
|-------|-------|-------|
| 1: | 10.3 | → |
| 2: | 10.2 | → |
| 3: | 10.8x | ↘ |
| 4: | 10.5x | ← |
| 5: | 9.9 | → |
| Serie | | 51.7 |
| Total | | 191.8 |

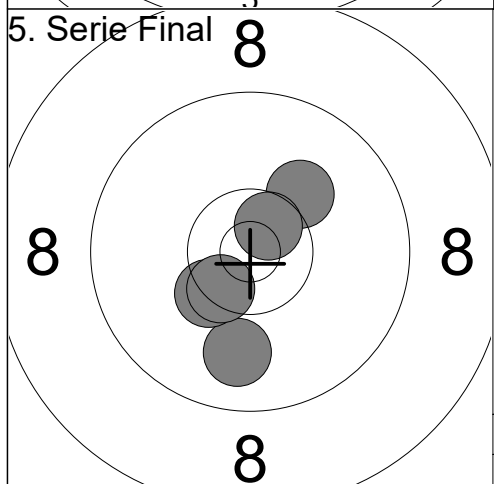

| | | |
|-------|-------|-------|
| 1: | 9.9 | ↓ |
| 2: | 10.2 | ↗ |
| 3: | 10.3x | ↘ |
| 4: | 10.6x | ↗ |
| 5: | 10.5x | ↘ |
| Serie | | 51.5 |
| Total | | 243.3 |

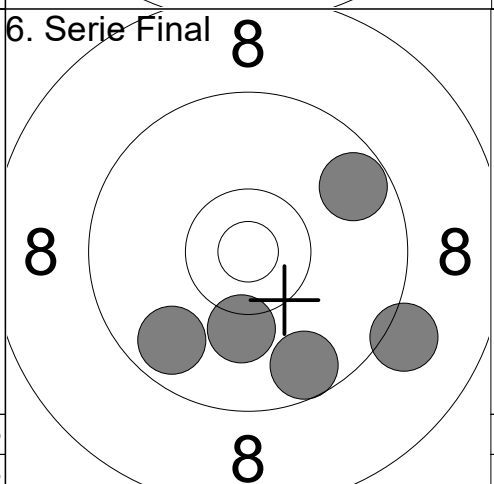

| | | |
|-------|------|-------|
| 1: | 10.2 | ↓ |
| 2: | 9.6 | ↓ |
| 3: | 9.7 | ↗ |
| 4: | 9.1 | ↘ |
| 5: | 9.7 | ↘ |
| Serie | | 48.3 |
| Total | | 291.6 |

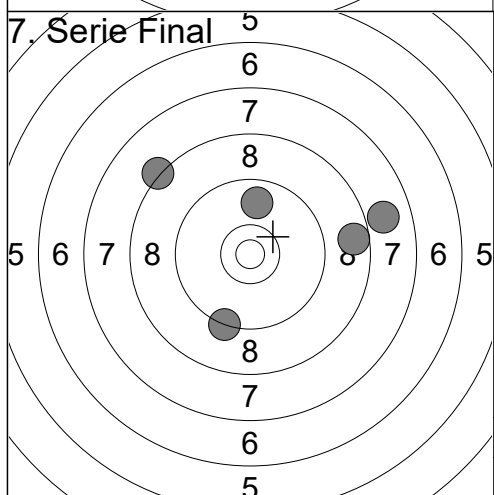

| | | |
|-------|-----|-------|
| 1: | 7.9 | → |
| 2: | 9.8 | ↑ |
| 3: | 9.3 | ↓ |
| 4: | 8.3 | ↗ |
| 5: | 8.6 | → |
| Serie | | 43.9 |
| Total | | 335.5 |

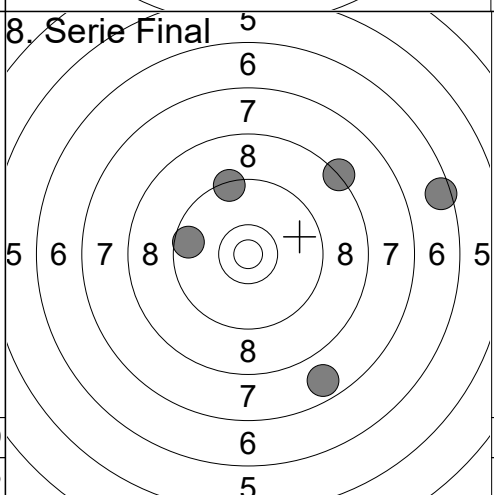

| | | |
|-------|-----|-------|
| 1: | 6.5 | → |
| 2: | 9.6 | ← |
| 3: | 8.3 | ↗ |
| 4: | 9.4 | ↑ |
| 5: | 7.7 | ↓ |
| Serie | | 41.5 |
| Total | | 377.0 |

| | | | |
|---------------------------|---|---------------------------|--|
| 1. Serie Final | 1: 8.7 ↘ 2: 9.6 ↘ 3: 10.3 ↗ 4: 7.7 ↗ 5: 8.9 ↖ | 2. Serie Final | 1: 9.1 ↗ 2: 10.0 ↖ 3: 10.0 ↗ 4: 9.3 → 5: 9.1 ↖ |
| | Serie 45.2 | | Serie 47.5 |
| | Total 45.2 | | Total 92.7 |

| | | | |
|---------------------------|---|---------------------------|--|
| 3. Serie Final | 1: 9.9 ↖ 2: 10.8x ↘ 3: 9.4 ↗ 4: 10.0 ↗ 5: 9.7 ↘ | 4. Serie Final | 1: 9.9 ↗ 2: 9.5 ↘ 3: 10.2 ↘ 4: 9.4 ↘ 5: 10.0 ↖ |
| | Serie 49.8 | | Serie 49.0 |
| | Total 142.5 | | Total 191.5 |

| | | | |
|---------------------------|--|---------------------------|--|
| 5. Serie Final | 1: 10.3 ↖ 2: 10.4x → 3: 10.3x ↗ 4: 10.6x ↖ 5: 10.2 ↘ | 6. Serie Final | 1: 10.1 ↖ 2: 9.5 → 3: 10.2 ↗ 4: 10.7x ↗ 5: 9.5 ↗ |
| | Serie 51.8 | | Serie 50.0 |
| | Total 243.3 | | Total 293.3 |

| | | | |
|---------------------------|--|---------------------------|--|
| 7. Serie Final | 1: 10.4x → 2: 10.7x ↖ 3: 8.6 ↘ 4: 9.7 ↗ 5: 8.9 ↘ | 8. Serie Final | 1: 9.6 → 2: 8.6 ↘ 3: 9.6 ↗ 4: 9.5 ↖ 5: 9.1 ↗ |
| | Serie 48.3 | | Serie 46.4 |
| | Total 341.6 | | Total 388.0 |

| | | | |
|---------------------------|-------------|----------------------------|-------------|
| 9. Serie Final | 1: 9.0 ↘ | 10. Serie Final | 1: 8.7 → |
| | Serie 9.0 | | Serie 8.7 |
| | Total 397.0 | | Total 405.7 |

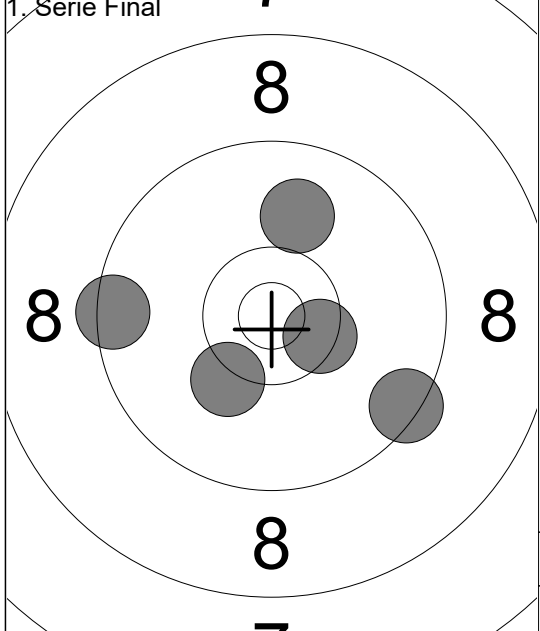

| | | | |
|-------|-------|---|------|
| 1: | 9.4 | ↘ | |
| 2: | 10.5x | → | |
| 3: | 10.0 | ↑ | |
| 4: | 10.2 | ↙ | |
| 5: | 9.4 | ← | |
| Serie | | | 49.5 |
| Total | | | 49.5 |

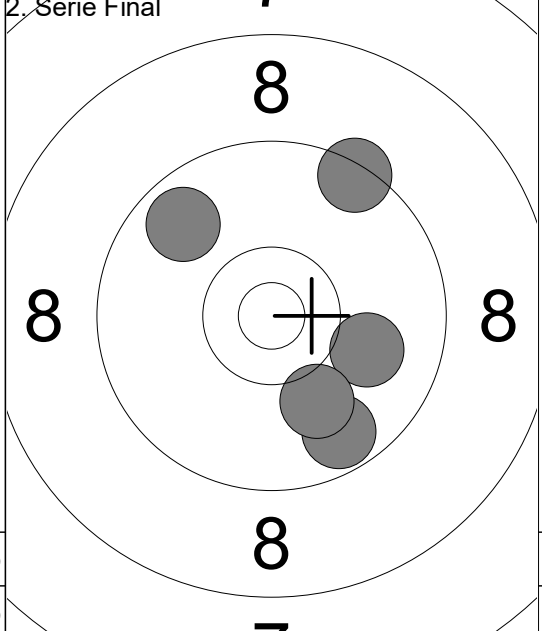

| | | | |
|-------|------|---|------|
| 1: | 9.8 | ↖ | |
| 2: | 10.0 | → | |
| 3: | 9.4 | ↑ | |
| 4: | 9.7 | ↘ | |
| 5: | 10.0 | ↙ | |
| Serie | | | 48.9 |
| Total | | | 98.4 |

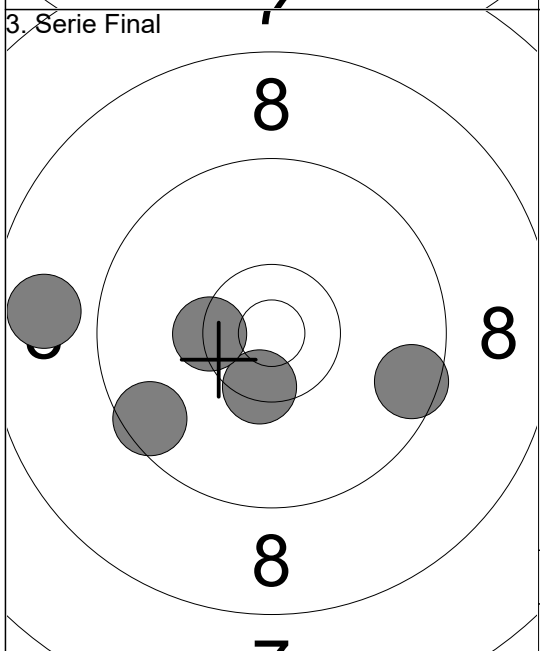

| | | | |
|-------|-------|---|-------|
| 1: | 10.4x | ↙ | |
| 2: | 9.5 | ↘ | |
| 3: | 8.8 | ← | |
| 4: | 10.4x | ↖ | |
| 5: | 9.6 | → | |
| Serie | | | 48.7 |
| Total | | | 147.1 |

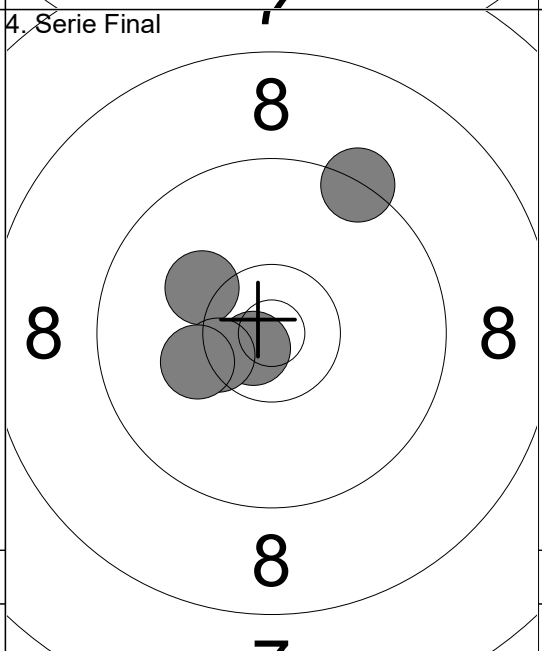

| | | | |
|-------|-------|---|-------|
| 1: | 10.7x | ↙ | |
| 2: | 10.2 | ↖ | |
| 3: | 10.4x | ↖ | |
| 4: | 10.2 | ↖ | |
| 5: | 9.3 | ↑ | |
| Serie | | | 50.8 |
| Total | | | 197.9 |

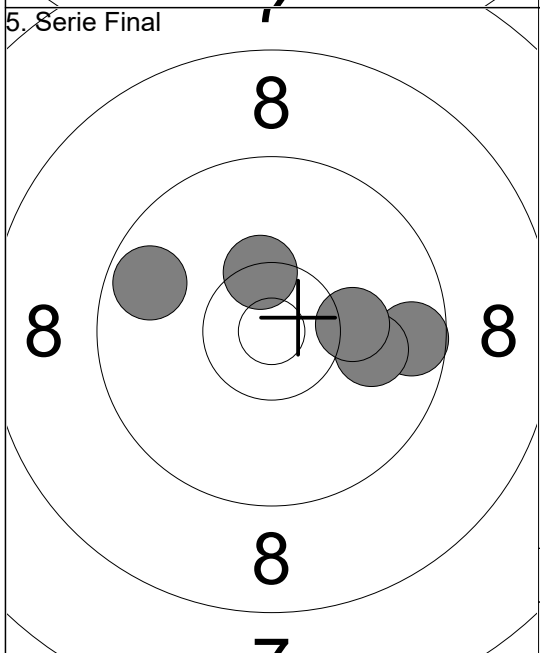

| | | | |
|-------|-------|---|-------|
| 1: | 10.4x | ↖ | |
| 2: | 9.6 | → | |
| 3: | 10.0 | → | |
| 4: | 10.2 | → | |
| 5: | 9.7 | ↖ | |
| Serie | | | 49.9 |
| Total | | | 247.8 |

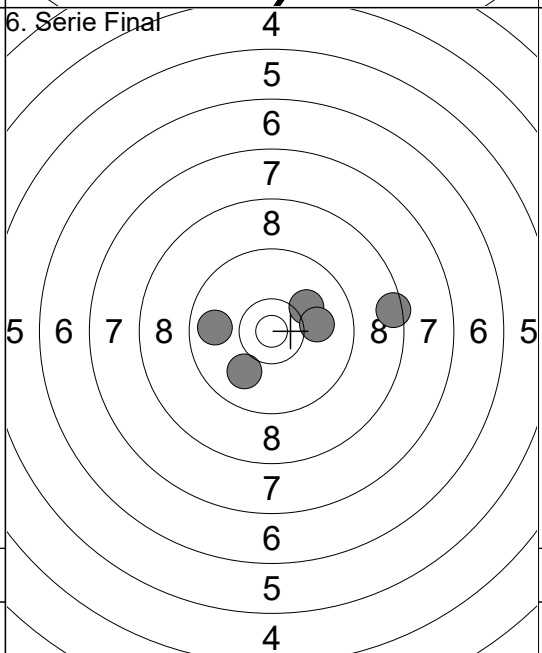

| | | | |
|-------|------|---|-------|
| 1: | 9.8 | ← | |
| 2: | 10.1 | ↗ | |
| 3: | 8.5 | → | |
| 4: | 10.0 | ↙ | |
| 5: | 10.0 | → | |
| Serie | | | 48.4 |
| Total | | | 296.2 |

7. Serie Final

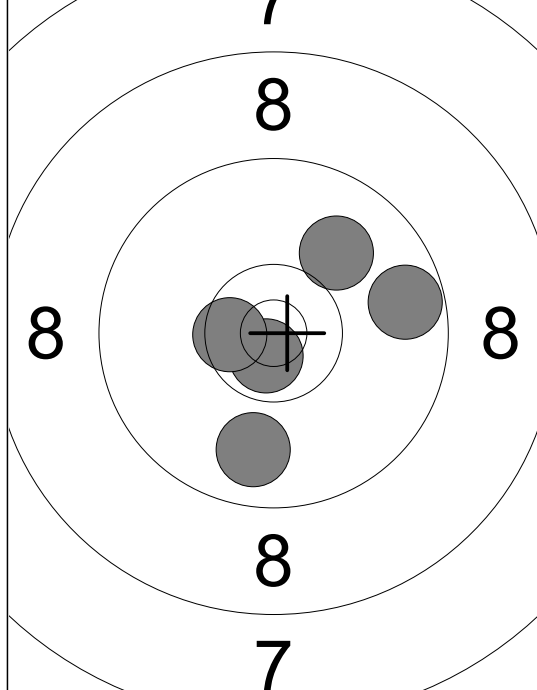

- 1: 9.7 →
- 2: 10.0 ↗
- 3: 10.7x ↘
- 4: 9.8 ↓
- 5: 10.5x ←

| | |
|-------|-------|
| Serie | 50.7 |
| Total | 346.9 |

8. Serie Final

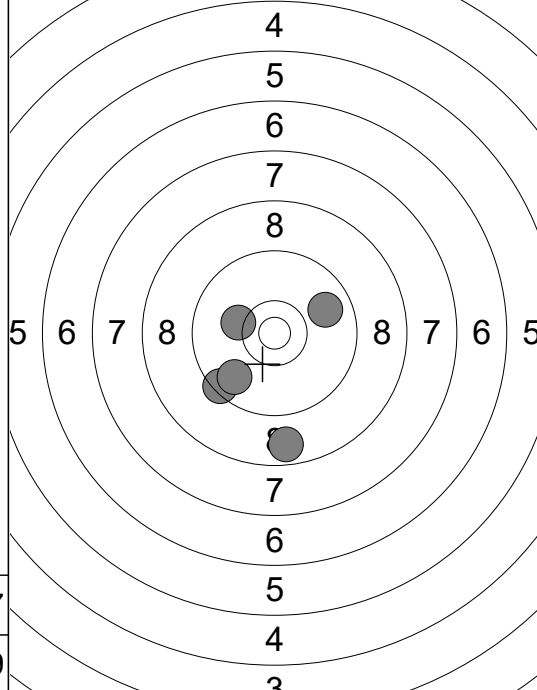

- 1: 9.8 →
- 2: 9.4 ↘
- 3: 10.2 ↗
- 4: 8.7 ↓
- 5: 9.8 ↙

| | |
|-------|-------|
| Serie | 47.9 |
| Total | 394.8 |

9. Serie Final

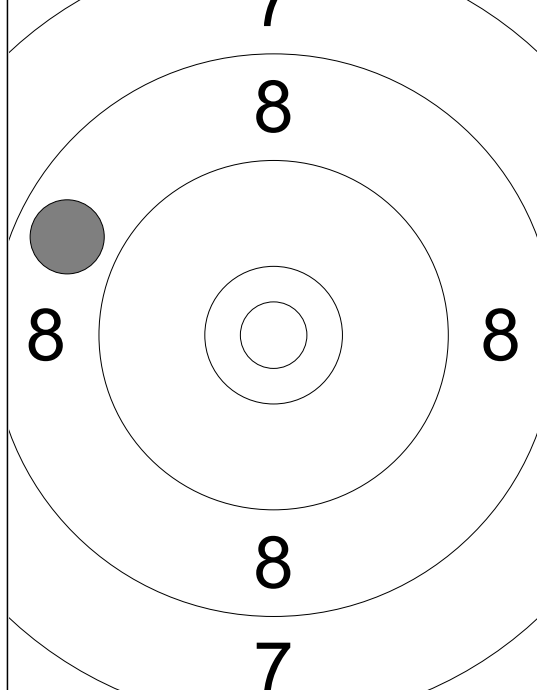

- 1: 8.8 ←

| | |
|-------|-------|
| Serie | 8.8 |
| Total | 403.6 |

10. Serie Final

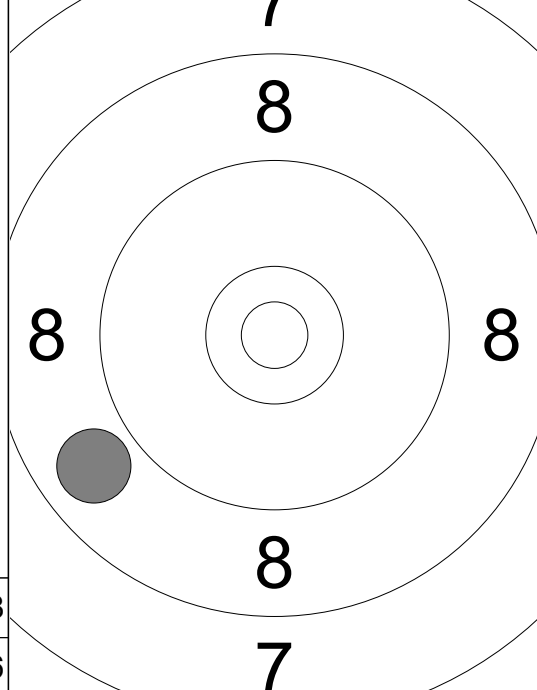

- 1: 8.8 ↙

| | |
|-------|-------|
| Serie | 8.8 |
| Total | 412.4 |

11. Serie Final

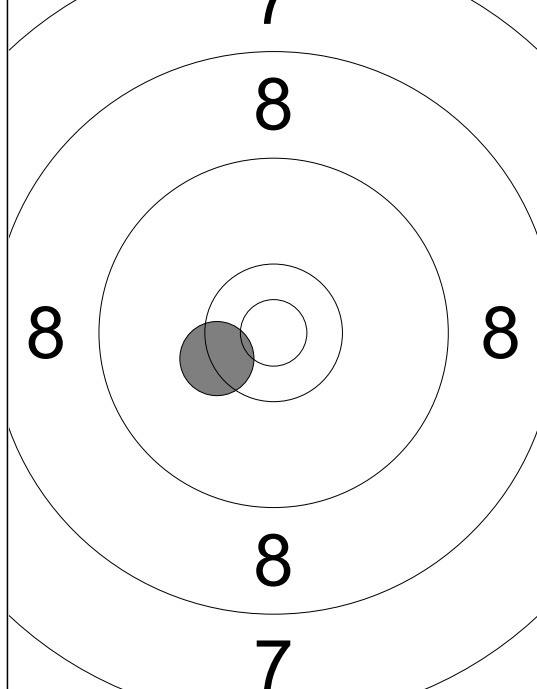

- 1: 10.4x ↘

| | |
|-------|-------|
| Serie | 10.4 |
| Total | 422.8 |

12. Serie Final

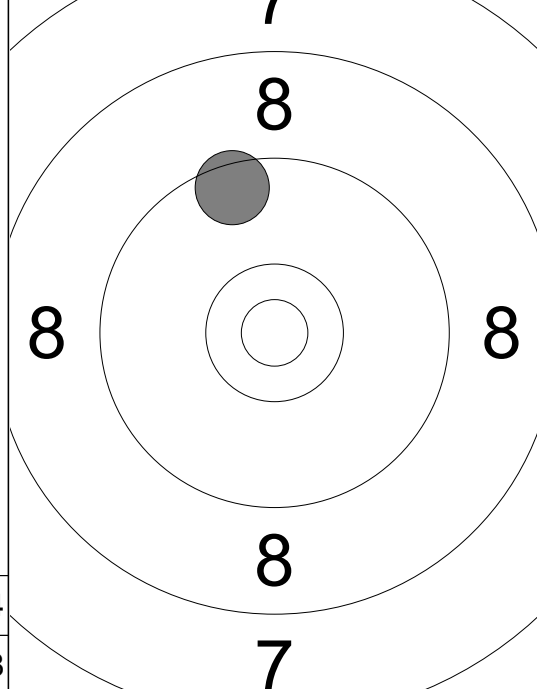

- 1: 9.5 ↗

| | |
|-------|-------|
| Serie | 9.5 |
| Total | 432.3 |

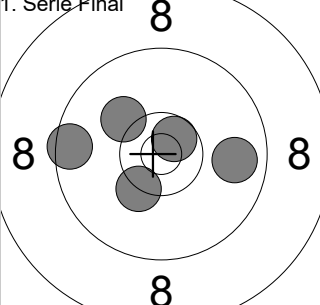
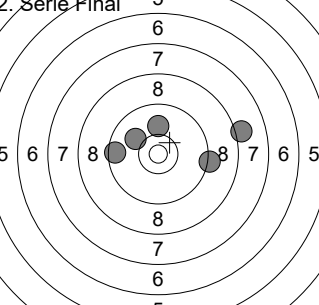
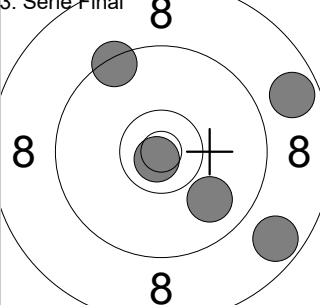
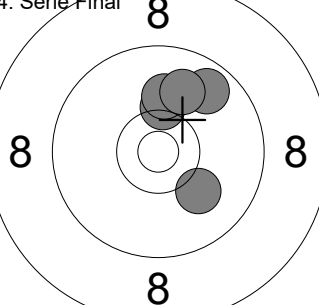
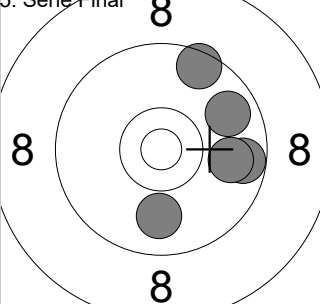
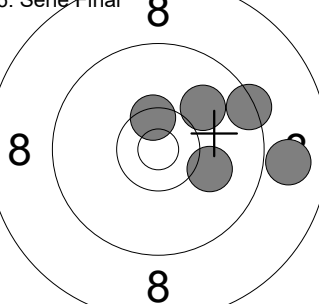
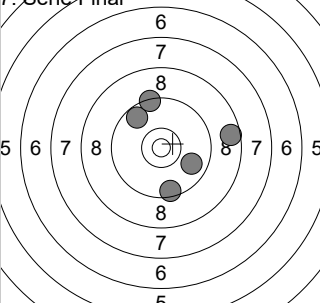
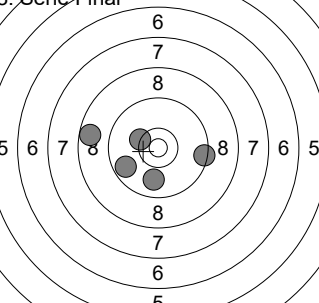
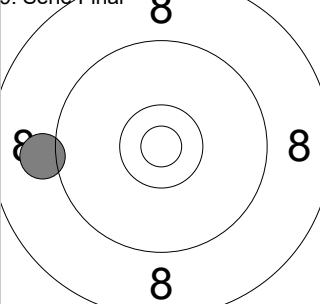
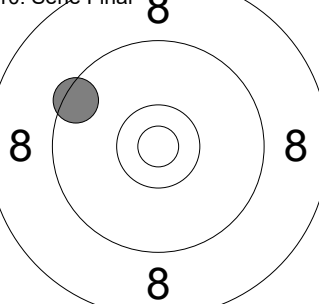
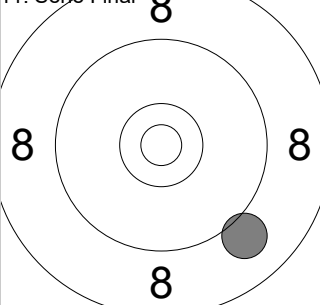
| | | | |
|--|---|--|--|
| 1. Serie Final  | 1: 10.6x ↗ 2: 10.3x ↘ 3: 9.8 → 4: 9.5 ↗ 5: 10.1 ↗ | 2. Serie Final  | 1: 10.0 ↑ 2: 10.0 ↗ 3: 9.5 ← 4: 9.2 → 5: 8.1 → |
| Serie 50.3 Total 50.3 | | Serie 46.8 Total 97.1 | |
| 3. Serie Final  | 1: 8.7 → 2: 9.9 ↘ 3: 10.8x ↘ 4: 9.4 ↗ 5: 8.7 ↘ | 4. Serie Final  | 1: 10.2 ↑ 2: 10.1 ↑ 3: 10.1 ↘ 4: 9.7 ↗ 5: 9.9 ↑ |
| Serie 47.5 Total 144.6 | | Serie 50.0 Total 194.6 | |
| 5. Serie Final  | 1: 9.9 ↓ 2: 9.7 → 3: 9.8 → 4: 9.5 ↗ 5: 9.9 → | 6. Serie Final  | 1: 10.0 ↗ 2: 8.9 → 3: 9.4 ↗ 4: 10.5x ↑ 5: 10.1 → |
| Serie 48.8 Total 243.4 | | Serie 48.9 Total 292.3 | |
| 7. Serie Final  | 1: 9.7 ↗ 2: 9.4 ↗ 3: 9.8 ↘ 4: 8.6 → 5: 9.5 ↓ | 8. Serie Final  | 1: 10.3 ↗ 2: 9.4 → 3: 9.9 ↓ 4: 9.7 ↘ 5: 8.7 ↗ |
| Serie 47.0 Total 339.3 | | Serie 48.0 Total 387.3 | |
| 9. Serie Final  | 1: 9.1 ← | 10. Serie Final  | 1: 9.5 ↗ |
| Serie 9.1 Total 396.4 | | Serie 9.5 Total 405.9 | |
| 11. Serie Final  | 1: 9.0 ↘ | | |
| Serie 9.0 Total 414.9 | | | |

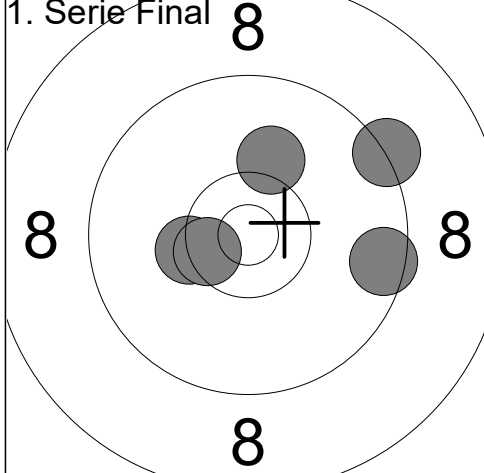

| | | |
|-------|-------|------|
| 1: | 10.3x | ← |
| 2: | 10.5x | ← |
| 3: | 9.3 | ↗ |
| 4: | 10.1 | ↑ |
| 5: | 9.5 | → |
| Serie | | 49.7 |
| Total | | 49.7 |

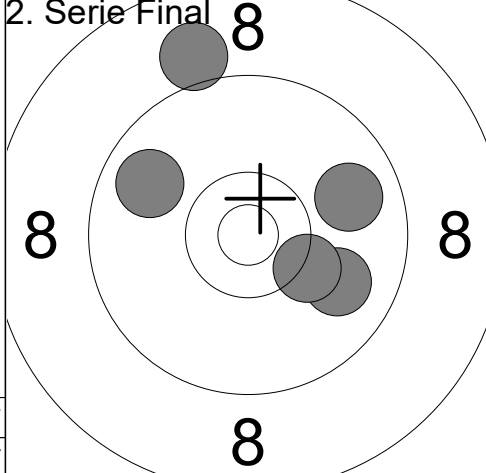

| | | |
|-------|------|------|
| 1: | 9.8 | ↖ |
| 2: | 9.8 | ↗ |
| 3: | 9.9 | ↘ |
| 4: | 9.0 | ↑ |
| 5: | 10.2 | ↘ |
| Serie | | 48.7 |
| Total | | 98.4 |

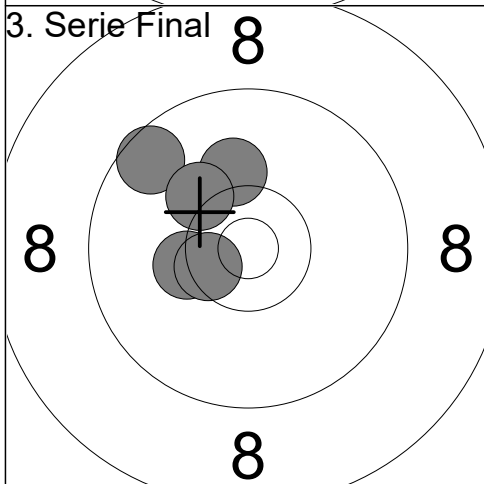

| | | |
|-------|-------|-------|
| 1: | 10.3x | ← |
| 2: | 10.1 | ↑ |
| 3: | 10.5x | ← |
| 4: | 9.6 | ↗ |
| 5: | 10.2 | ↗ |
| Serie | | 50.7 |
| Total | | 149.1 |

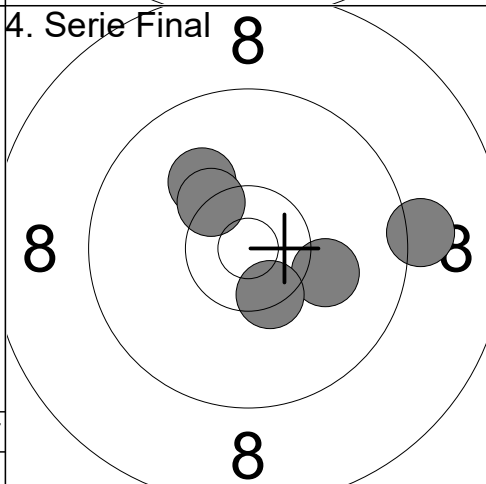

| | | |
|-------|-------|-------|
| 1: | 9.2 | → |
| 2: | 10.1 | ↗ |
| 3: | 10.1 | ↘ |
| 4: | 10.4x | ↘ |
| 5: | 10.3x | ↗ |
| Serie | | 50.1 |
| Total | | 199.2 |

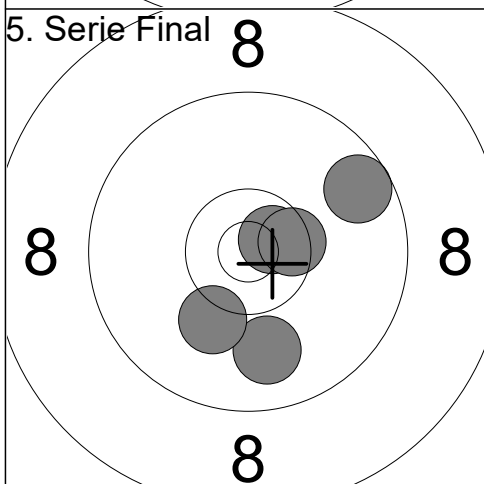

| | | |
|-------|-------|-------|
| 1: | 10.7x | ↗ |
| 2: | 9.9 | ↘ |
| 3: | 10.5x | → |
| 4: | 9.6 | ↗ |
| 5: | 10.2 | ↘ |
| Serie | | 50.9 |
| Total | | 250.1 |

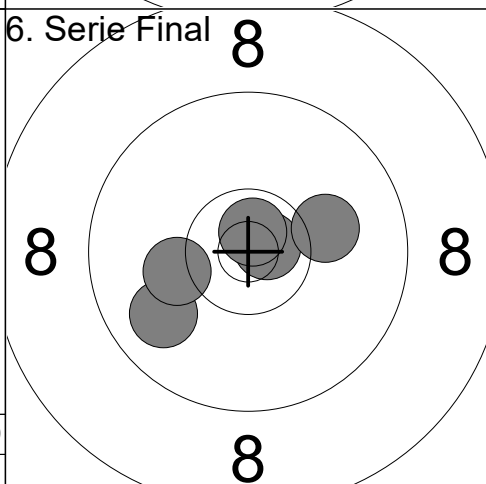

| | | |
|-------|-------|-------|
| 1: | 9.9 | ↖ |
| 2: | 10.7x | → |
| 3: | 10.1 | → |
| 4: | 10.7x | ↑ |
| 5: | 10.2 | ← |
| Serie | | 51.6 |
| Total | | 301.7 |

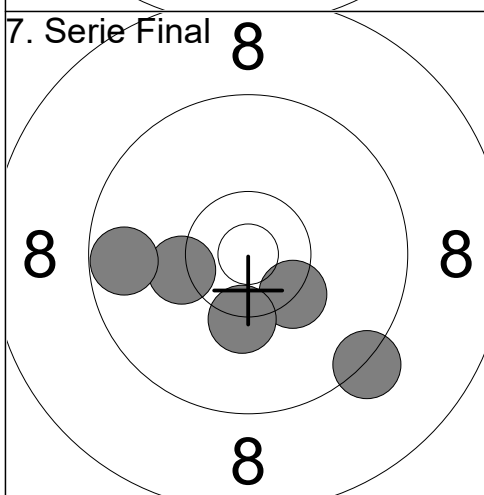

| | | |
|-------|-------|-------|
| 1: | 10.2 | ← |
| 2: | 10.3x | ↘ |
| 3: | 9.7 | ← |
| 4: | 9.3 | ↘ |
| 5: | 10.3 | ↘ |
| Serie | | 49.8 |
| Total | | 351.5 |

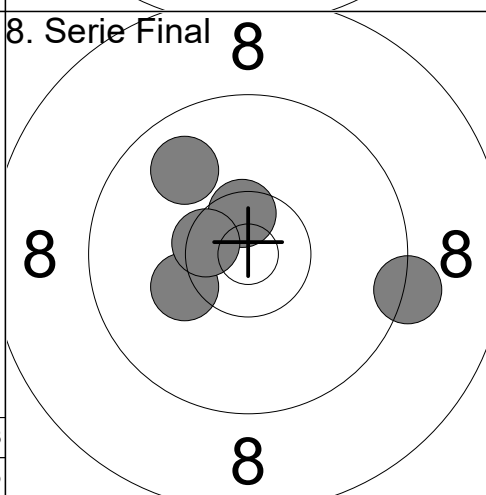

| | | |
|-------|-------|-------|
| 1: | 10.5x | ↑ |
| 2: | 10.2 | ← |
| 3: | 9.3 | → |
| 4: | 9.9 | ↗ |
| 5: | 10.5x | ↖ |
| Serie | | 50.4 |
| Total | | 401.9 |

9. Serie Final

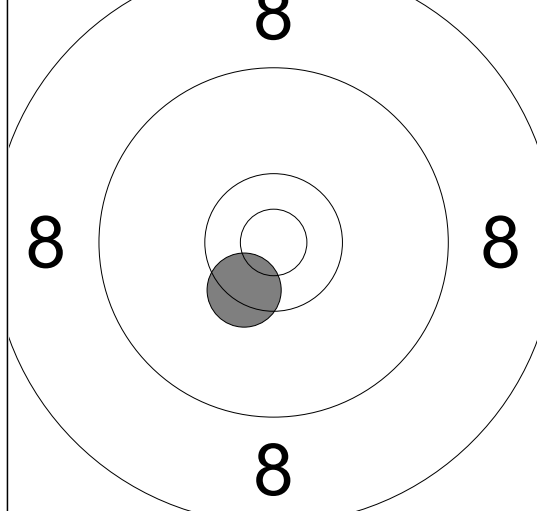

| | |
|-------|-------|
| Serie | 10.4 |
| Total | 412.3 |

10. Serie Final

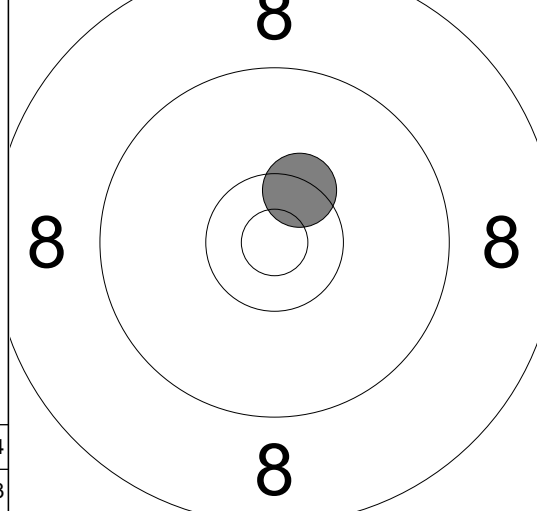

| | |
|-------|-------|
| Serie | 10.4 |
| Total | 422.7 |

11. Serie Final

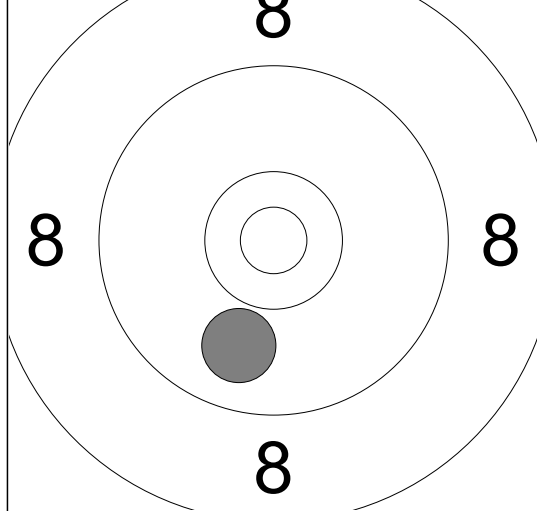

| | |
|-------|-------|
| Serie | 9.9 |
| Total | 432.6 |

12. Serie Final

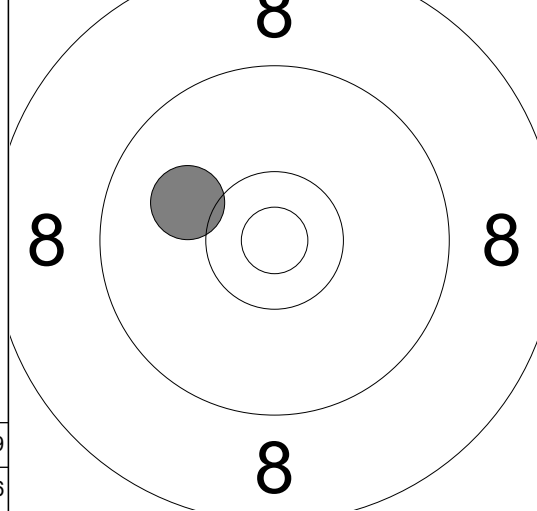

| | |
|-------|-------|
| Serie | 10.1 |
| Total | 442.7 |

13. Serie Final

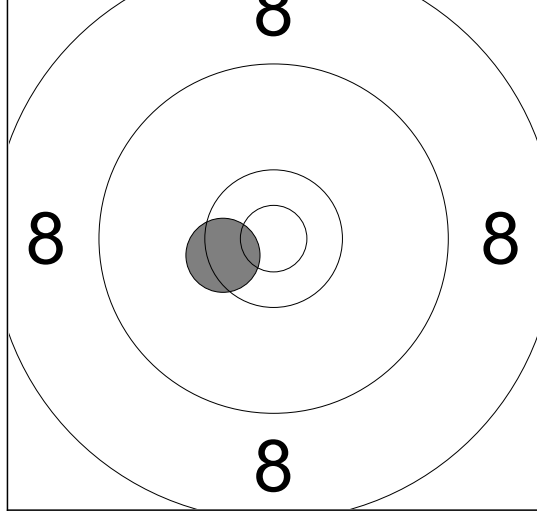

| | |
|-------|-------|
| Serie | 10.5 |
| Total | 453.2 |

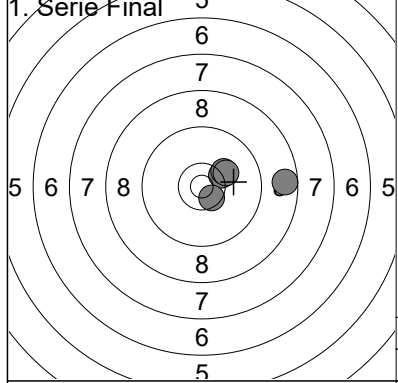
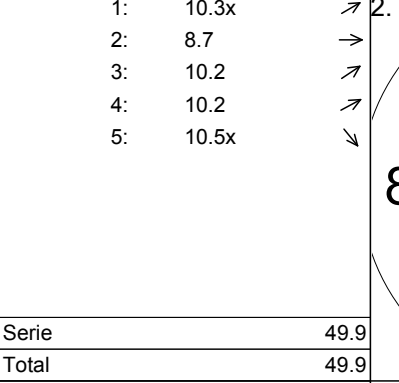
| | | | |
|---|--|--|---|
| 1. Serie Final  | 1: 10.3x ↗ 2: 8.7 → 3: 10.2 ↗ 4: 10.2 ↗ 5: 10.5x ↘ | 2. Serie Final  | 1: 10.3x ↙ 2: 10.7x ↗ 3: 10.5x → 4: 10.7x ↗ 5: 10.0 ↘ |
| Serie 49.9 | | Serie 52.2 | |
| Total 49.9 | | Total 102.1 | |

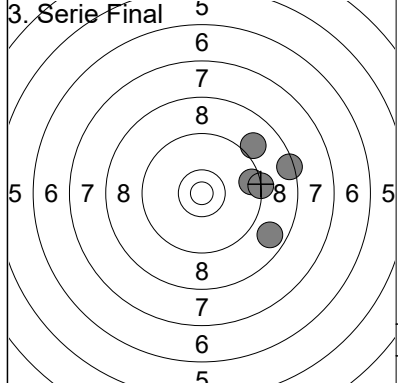
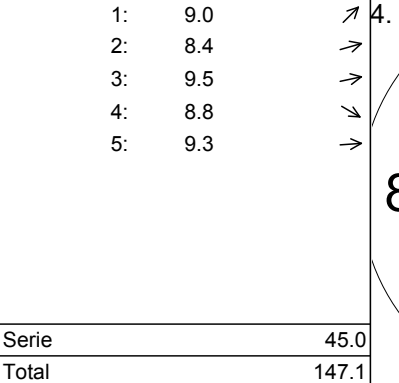
| | | | |
|---|--|--|---|
| 3. Serie Final  | 1: 9.0 ↗ 2: 8.4 → 3: 9.5 → 4: 8.8 ↘ 5: 9.3 → | 4. Serie Final  | 1: 9.8 → 2: 9.3 → 3: 10.5x → 4: 9.5 ↘ 5: 10.2 ↑ |
| Serie 45.0 | | Serie 49.3 | |
| Total 147.1 | | Total 196.4 | |

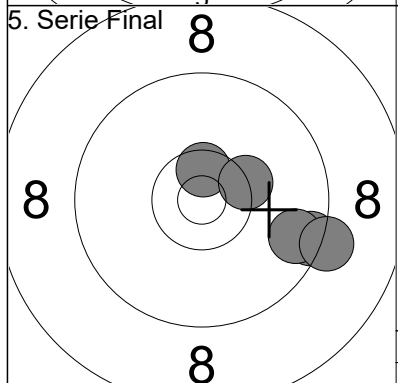
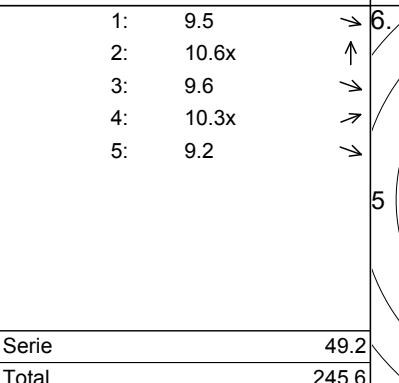
| | | | |
|--|--|---|--|
| 5. Serie Final  | 1: 9.5 → 2: 10.6x ↑ 3: 9.6 ↘ 4: 10.3x → 5: 9.2 ↘ | 6. Serie Final  | 1: 10.3x ↑ 2: 8.6 → 3: 7.7 ↘ 4: 9.7 → 5: 8.4 → |
| Serie 49.2 | | Serie 44.7 | |
| Total 245.6 | | Total 290.3 | |

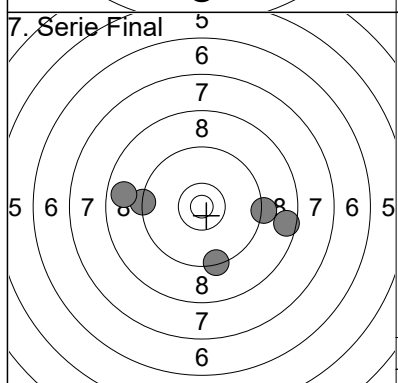
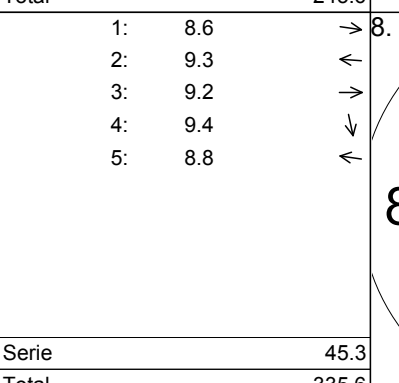
| | | | |
|---|--|--|---|
| 7. Serie Final  | 1: 8.6 → 2: 9.3 ↙ 3: 9.2 → 4: 9.4 ↘ 5: 8.8 ↙ | 8. Serie Final  | 1: 9.0 → 2: 9.4 ↙ 3: 9.6 ↙ 4: 10.0 → 5: 9.7 ↙ |
| Serie 45.3 | | Serie 47.7 | |
| Total 335.6 | | Total 383.3 | |

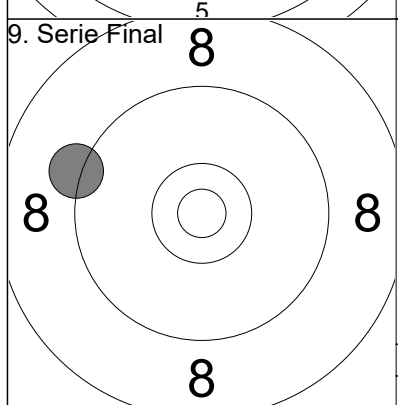
| | | | |
|---|----------|--|--|
| 9. Serie Final  | 1: 9.2 ↙ | | |
| Serie 9.2 | | | |
| Total 392.5 | | | |

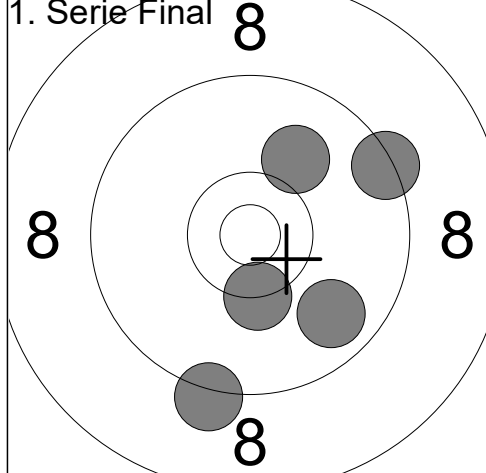

| | | |
|-------|-------|------|
| 1: | 9.2 | ↓ |
| 2: | 9.8 | ↘ |
| 3: | 10.3x | ↓ |
| 4: | 9.4 | ↗ |
| 5: | 10.0 | ↗ |
| Serie | | 48.7 |
| Total | | 48.7 |

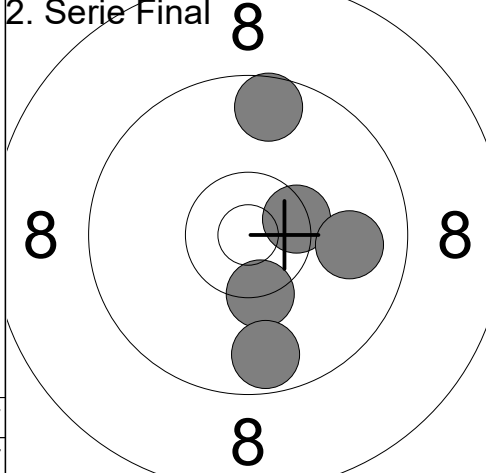

| | | |
|-------|-------|------|
| 1: | 9.6 | ↑ |
| 2: | 10.4x | → |
| 3: | 10.3x | ↓ |
| 4: | 9.9 | → |
| 5: | 9.7 | ↓ |
| Serie | | 49.9 |
| Total | | 98.6 |

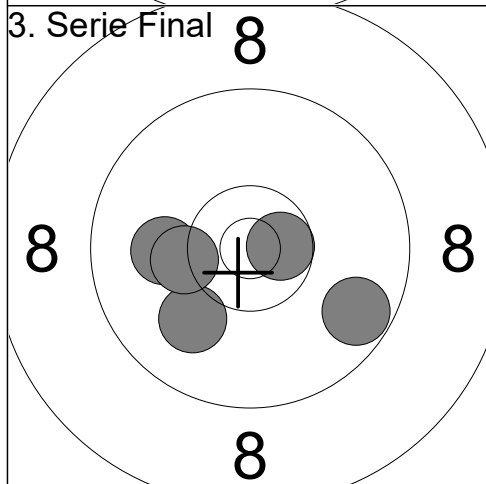

| | | |
|-------|-------|-------|
| 1: | 10.0 | ↘ |
| 2: | 10.1 | ← |
| 3: | 10.3 | ← |
| 4: | 10.6x | → |
| 5: | 9.7 | ↘ |
| Serie | | 50.7 |
| Total | | 149.3 |

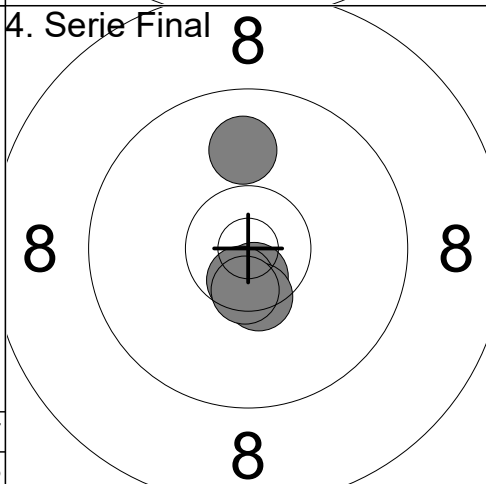

| | | |
|-------|-------|-------|
| 1: | 10.7x | ↓ |
| 2: | 10.6x | ↓ |
| 3: | 10.4x | ↓ |
| 4: | 9.9 | ↑ |
| 5: | 10.5x | ↓ |
| Serie | | 52.1 |
| Total | | 201.4 |

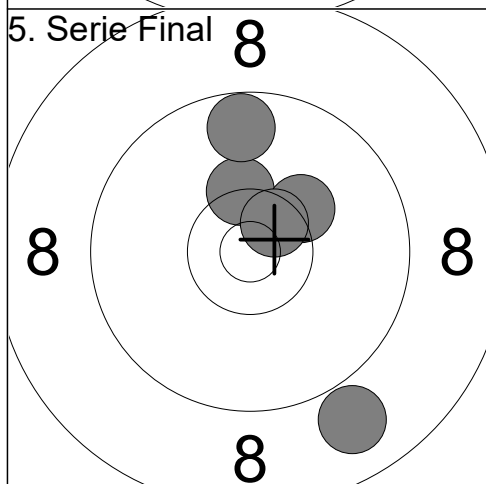

| | | |
|-------|-------|-------|
| 1: | 10.3x | ↑ |
| 2: | 10.3 | ↗ |
| 3: | 9.7 | ↑ |
| 4: | 10.6x | ↗ |
| 5: | 8.9 | ↓ |
| Serie | | 49.8 |
| Total | | 251.2 |

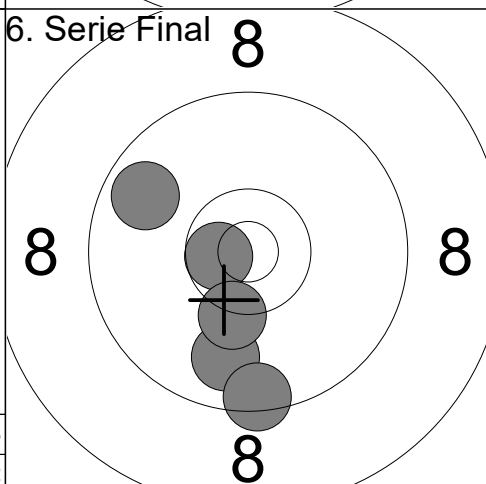

| | | |
|-------|-------|-------|
| 1: | 9.8 | ↓ |
| 2: | 10.6x | ← |
| 3: | 10.3 | ↓ |
| 4: | 9.7 | ↖ |
| 5: | 9.4 | ↓ |
| Serie | | 49.8 |
| Total | | 301.0 |

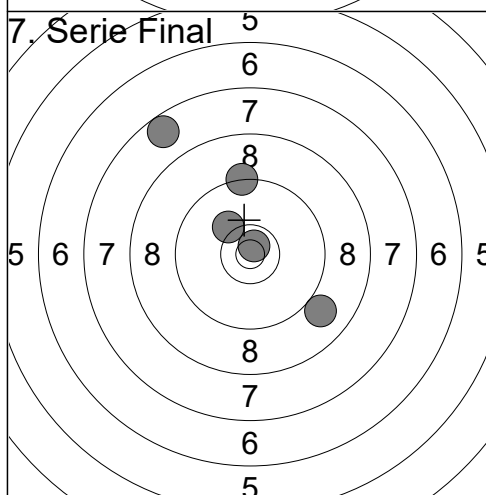

| | | |
|-------|-------|-------|
| 1: | 10.8x | ↑ |
| 2: | 7.6 | ↗ |
| 3: | 10.2 | ↗ |
| 4: | 9.0 | ↘ |
| 5: | 9.3 | ↑ |
| Serie | | 46.9 |
| Total | | 347.9 |

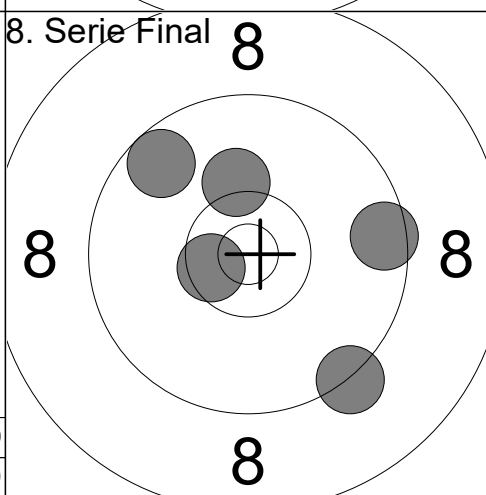

| | | |
|-------|-------|-------|
| 1: | 9.5 | → |
| 2: | 9.7 | ↗ |
| 3: | 10.2 | ↑ |
| 4: | 10.5x | ← |
| 5: | 9.3 | ↓ |
| Serie | | 49.2 |
| Total | | 397.1 |

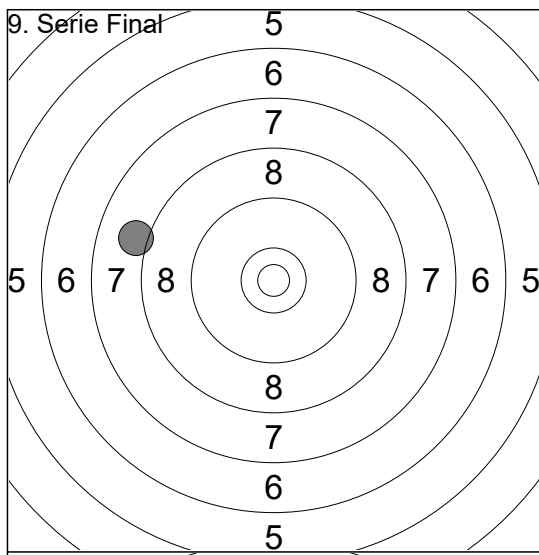

1: 8.1 ←

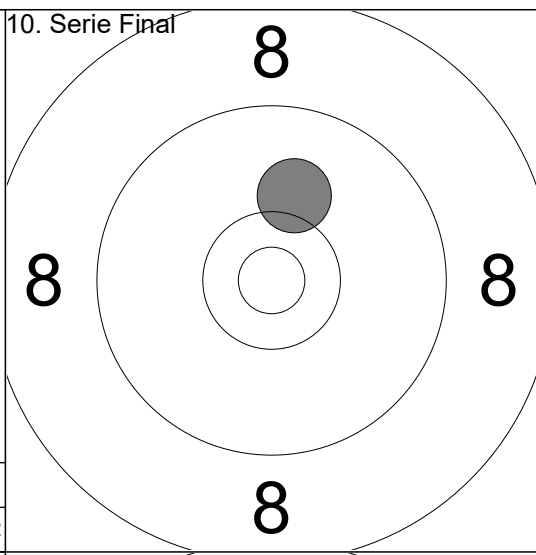

1: 10.1 ↗

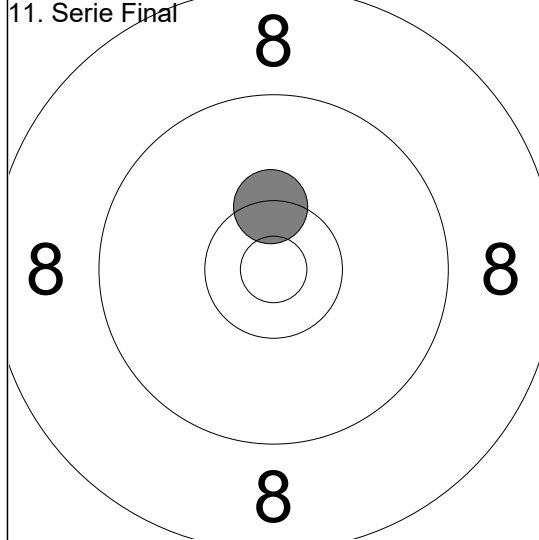

1: 10.4x ↗

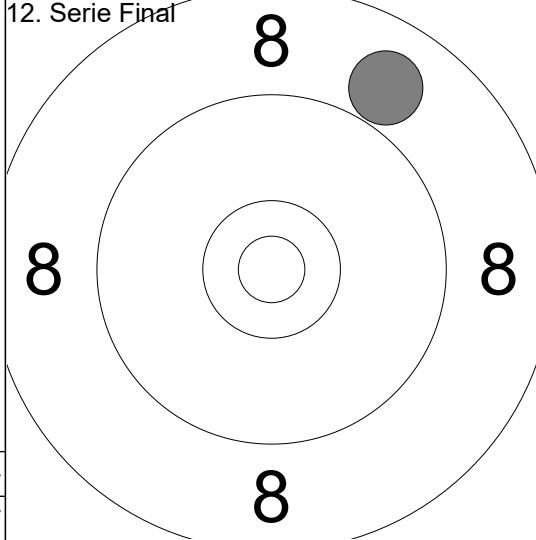

1: 8.9 ↗

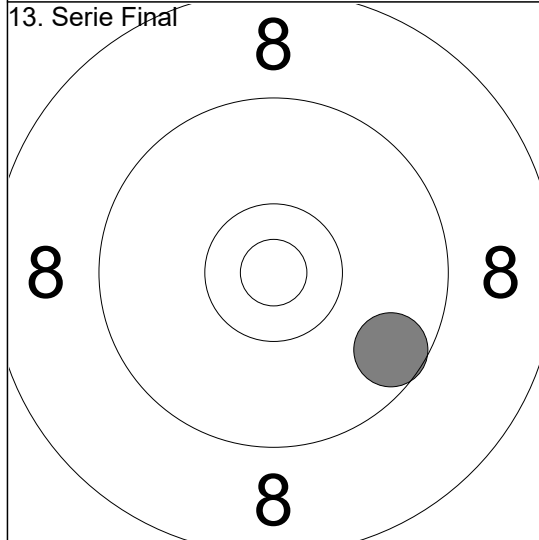

1: 9.6 ↘

| | |
|--|--|
| | |
|--|--|

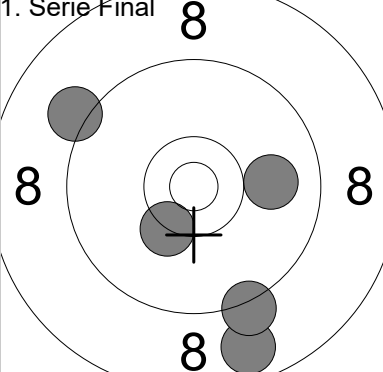
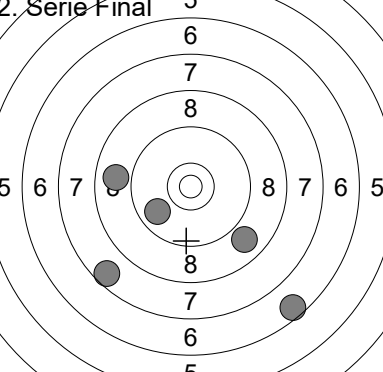
| | | | |
|---|--|---|--|
| 1. Serie Final  | 1: 9.9 → 2: 8.8 ↓ 3: 9.2 ↓ 4: 10.3x ↓ 5: 9.1 ↑ | 2. Serie Final  | 1: 9.8 ↙ 2: 8.9 ← 3: 6.6 ↓ 4: 7.6 ↙ 5: 8.9 ↓ |
| | Serie 47.3 | | Serie 41.8 |
| | Total 47.3 | | Total 89.1 |

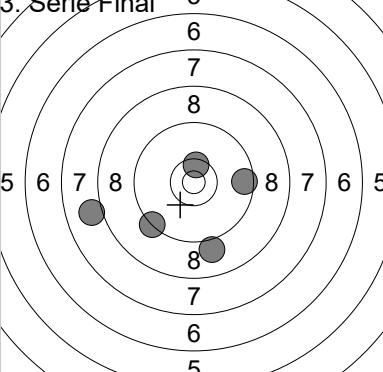
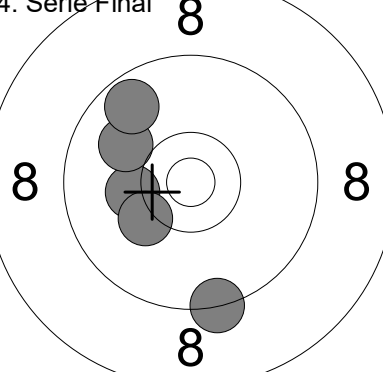
| | | | |
|---|--|---|---|
| 3. Serie Final  | 1: 9.3 ↙ 2: 8.0 ← 3: 10.5x ↑ 4: 9.0 ↓ 5: 9.5 → | 4. Serie Final  | 1: 10.2 ← 2: 9.3 ↓ 3: 10.0 ↗ 4: 9.7 ↗ 5: 10.2 ↙ |
| | Serie 46.3 | | Serie 49.4 |
| | Total 135.4 | | Total 184.8 |

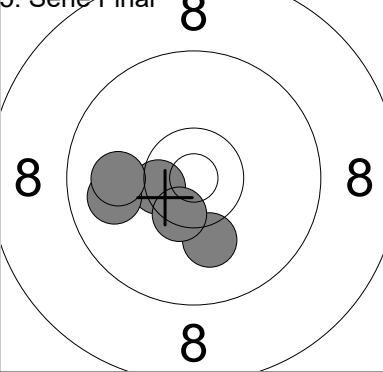
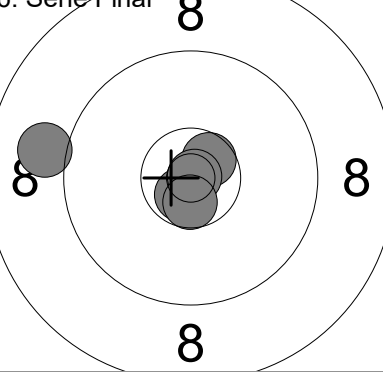
| | | | |
|--|--|--|--|
| 5. Serie Final  | 1: 10.5x ← 2: 10.1 ↓ 3: 10.4x ↓ 4: 9.9 ← 5: 10.0 ← | 6. Serie Final  | 1: 9.0 ← 2: 10.7x ↓ 3: 10.6x ↗ 4: 10.9x ↗ 5: 10.6x ↓ |
| | Serie 50.9 | | Serie 51.8 |
| | Total 235.7 | | Total 287.5 |

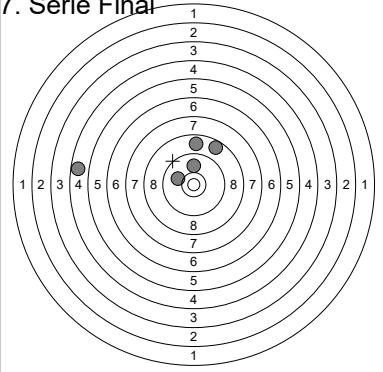
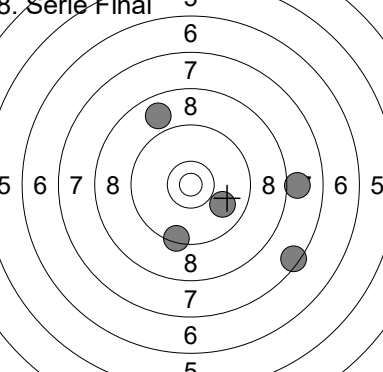
| | | | |
|---|--|---|--|
| 7. Serie Final  | 1: 4.7 ← 2: 8.8 ↑ 3: 8.7 ↗ 4: 10.0 ↑ 5: 10.0 ↖ | 8. Serie Final  | 1: 8.0 → 2: 9.4 ↓ 3: 8.8 ↗ 4: 7.5 ↓ 5: 9.9 ↓ |
| | Serie 42.2 | | Serie 43.6 |
| | Total 329.7 | | Total 373.3 |

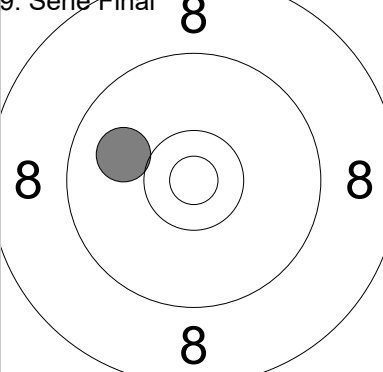
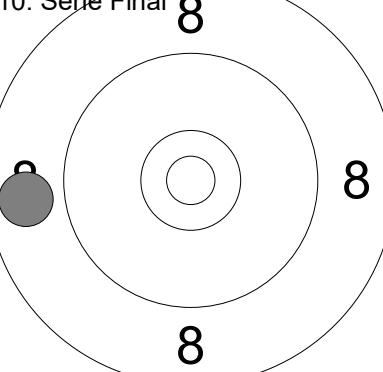
| | | | |
|---|-------------|--|-------------|
| 9. Serie Final  | 1: 10.0 ← | 10. Serie Final  | 1: 8.8 ← |
| | Serie 10.0 | | Serie 8.8 |
| | Total 383.3 | | Total 392.1 |

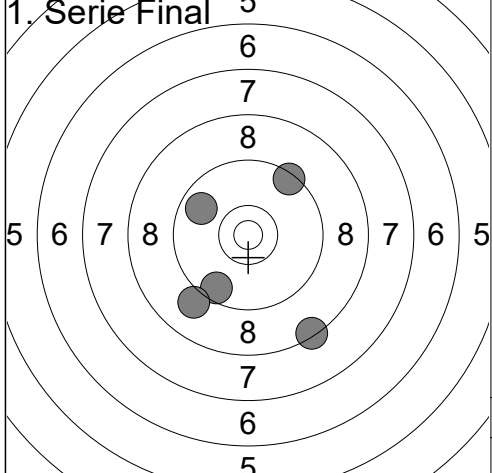

| | | |
|-------|-----|------|
| 1: | 9.6 | ↘ |
| 2: | 8.4 | ↘ |
| 3: | 9.8 | ↗ |
| 4: | 9.4 | ↗ |
| 5: | 9.0 | ↘ |
| Serie | | 46.2 |
| Total | | 46.2 |

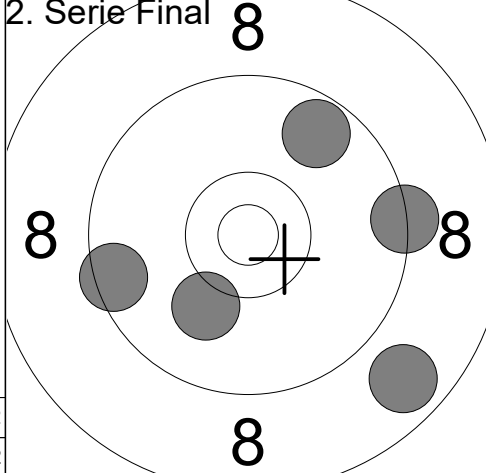

| | | |
|-------|------|------|
| 1: | 9.5 | ← |
| 2: | 10.1 | ↘ |
| 3: | 9.3 | → |
| 4: | 9.7 | ↗ |
| 5: | 8.8 | ↘ |
| Serie | | 47.4 |
| Total | | 93.6 |

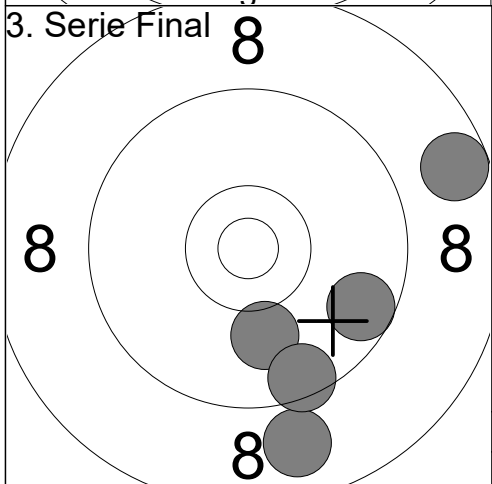

| | | |
|-------|------|-------|
| 1: | 10.0 | ↓ |
| 2: | 9.6 | → |
| 3: | 8.6 | → |
| 4: | 8.9 | ↘ |
| 5: | 9.5 | ↘ |
| Serie | | 46.6 |
| Total | | 140.2 |

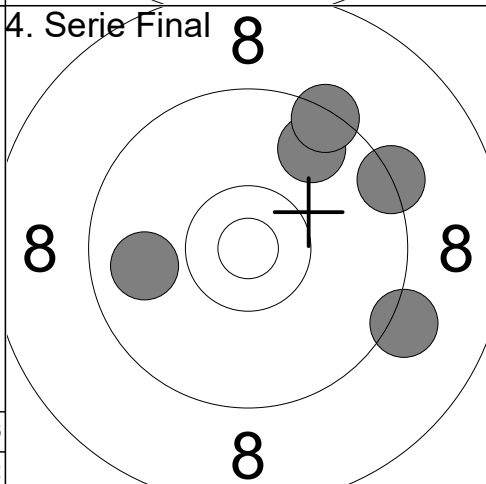

| | | |
|-------|-----|-------|
| 1: | 9.7 | ↗ |
| 2: | 9.4 | ↗ |
| 3: | 9.9 | ← |
| 4: | 9.2 | → |
| 5: | 9.3 | → |
| Serie | | 47.5 |
| Total | | 187.7 |

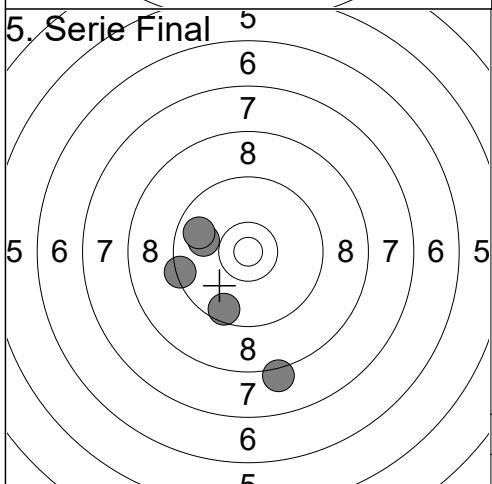

| | | |
|-------|-----|-------|
| 1: | 9.9 | ← |
| 2: | 8.1 | ↘ |
| 3: | 9.4 | ← |
| 4: | 9.6 | ↘ |
| 5: | 9.8 | ← |
| Serie | | 46.8 |
| Total | | 234.5 |

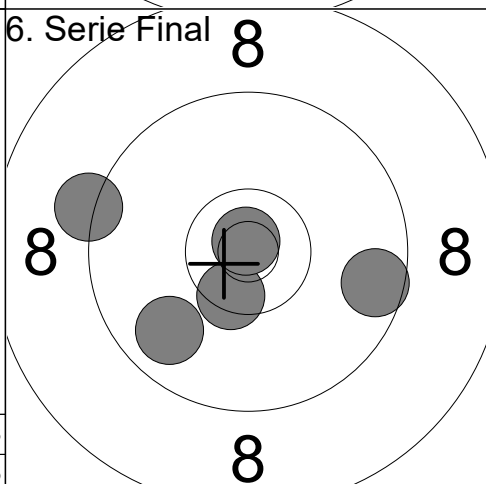

| | | |
|-------|-------|-------|
| 1: | 9.6 | → |
| 2: | 9.8 | ↘ |
| 3: | 10.5x | ↘ |
| 4: | 10.8x | ↗ |
| 5: | 9.2 | ← |
| Serie | | 49.9 |
| Total | | 284.4 |

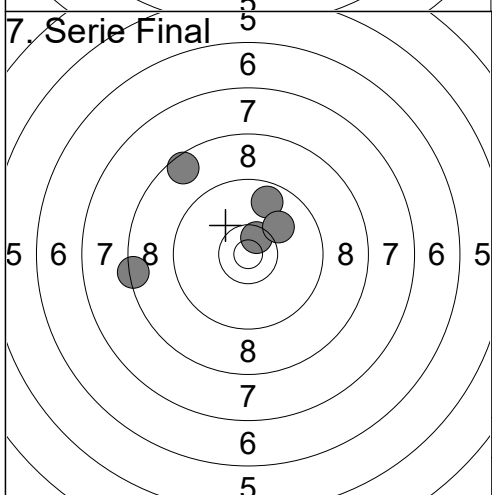

| | | |
|-------|-------|-------|
| 1: | 10.5x | ↗ |
| 2: | 9.7 | ↗ |
| 3: | 8.6 | ↘ |
| 4: | 10.1 | ↗ |
| 5: | 8.4 | ← |
| Serie | | 47.3 |
| Total | | 331.7 |

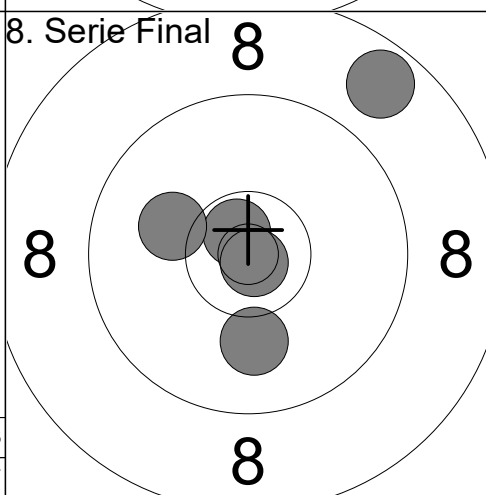

| | | |
|-------|-------|-------|
| 1: | 10.7x | ↗ |
| 2: | 8.7 | ↗ |
| 3: | 10.1 | ← |
| 4: | 10.8x | ↘ |
| 5: | 10.0 | ↓ |
| Serie | | 50.3 |
| Total | | 382.0 |

9. Serie Final

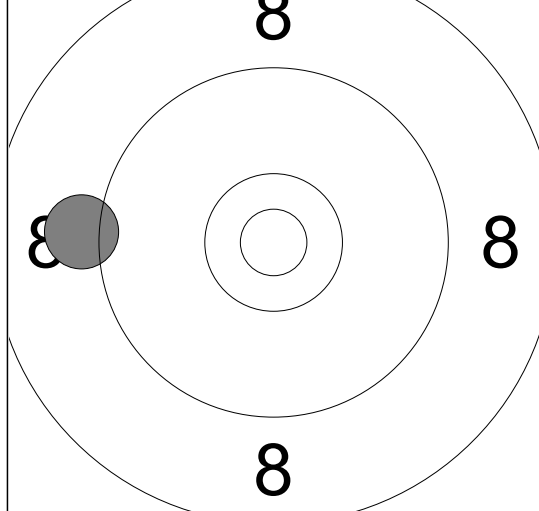

| | |
|-------|-------|
| Serie | 9.1 |
| Total | 391.1 |

10. Serie Final

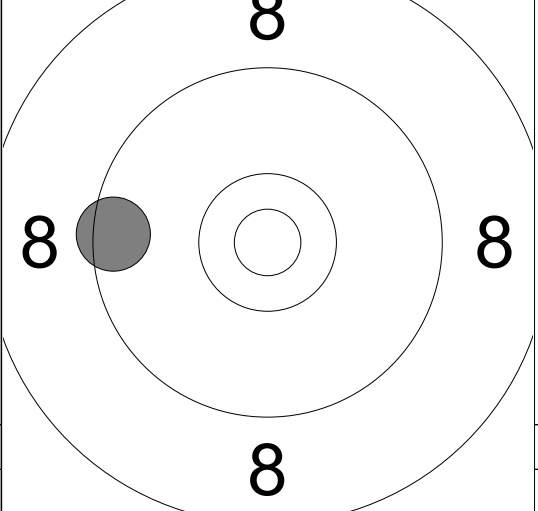

| | |
|-------|-------|
| Serie | 9.5 |
| Total | 400.6 |

11. Serie Final

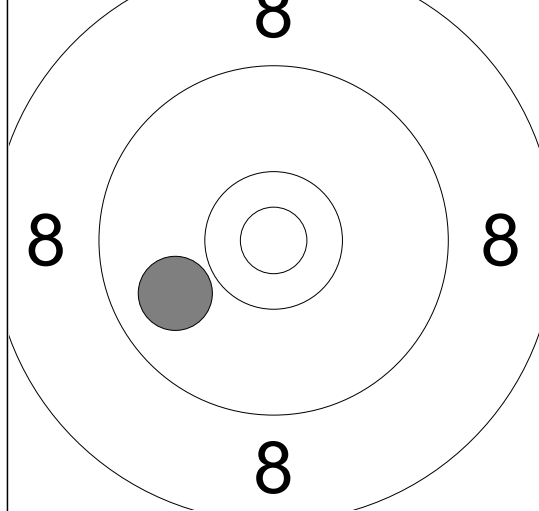

| | |
|-------|-------|
| Serie | 9.9 |
| Total | 410.5 |

12. Serie Final

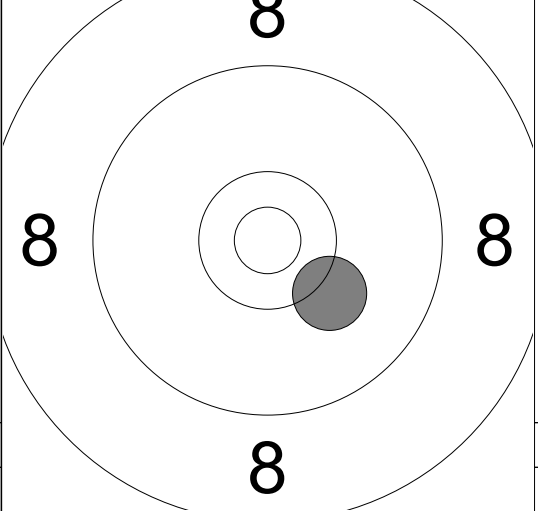

| | |
|-------|-------|
| Serie | 10.2 |
| Total | 420.7 |

13. Serie Final

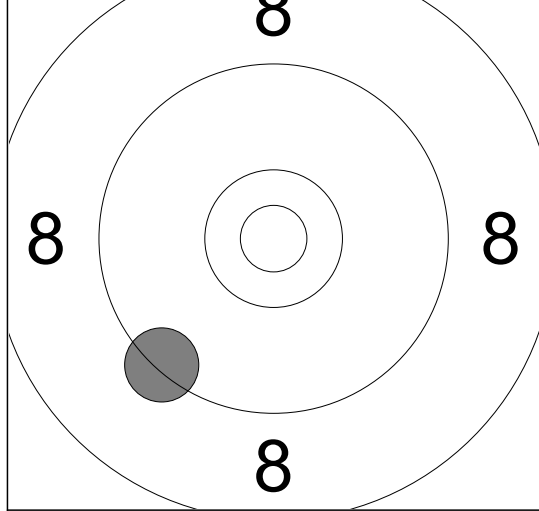

| | |
|-------|-------|
| Serie | 9.4 |
| Total | 430.1 |

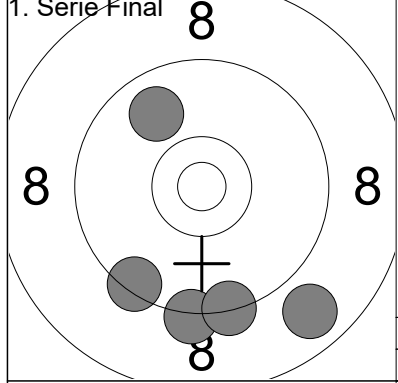

| | | |
|-------|-----|------|
| 1: | 9.3 | ↓ |
| 2: | 9.3 | ↓ |
| 3: | 8.8 | ↓ |
| 4: | 9.8 | ↗ |
| 5: | 9.4 | ↓ |
| Serie | | 46.6 |
| Total | | 46.6 |

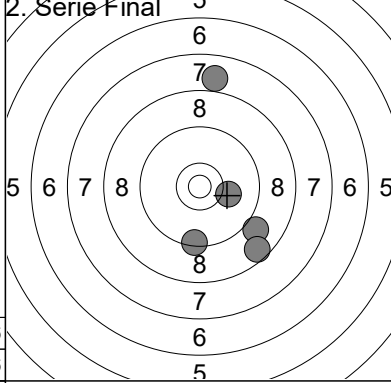

| | | |
|-------|------|------|
| 1: | 7.9 | ↑ |
| 2: | 9.0 | ↓ |
| 3: | 10.1 | → |
| 4: | 8.6 | ↓ |
| 5: | 9.4 | ↓ |
| Serie | | 45.0 |
| Total | | 91.6 |

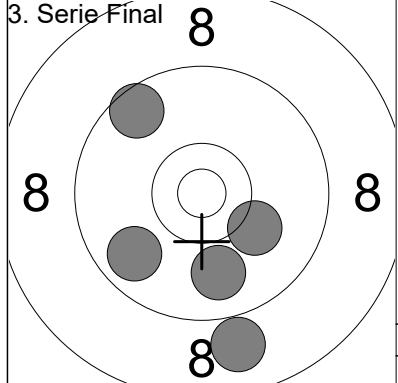

| | | |
|-------|------|-------|
| 1: | 9.9 | ↓ |
| 2: | 9.8 | ↓ |
| 3: | 10.1 | ↓ |
| 4: | 9.6 | ↗ |
| 5: | 8.9 | ↓ |
| Serie | | 48.3 |
| Total | | 139.9 |

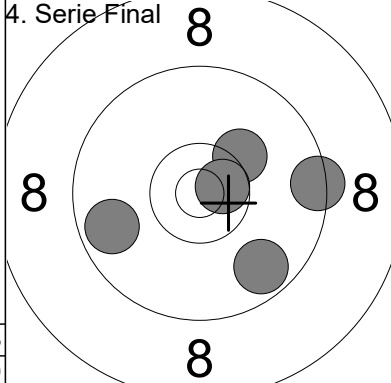

| | | |
|-------|-------|-------|
| 1: | 9.4 | → |
| 2: | 9.7 | ↓ |
| 3: | 10.2 | ↗ |
| 4: | 9.7 | ← |
| 5: | 10.6x | → |
| Serie | | 49.6 |
| Total | | 189.5 |

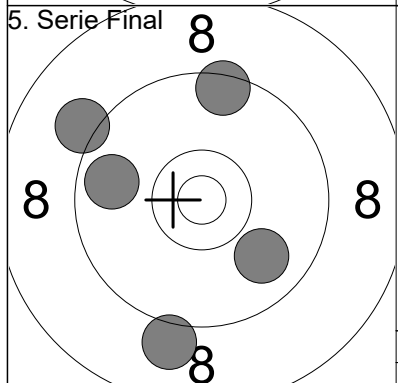

| | | |
|-------|-----|-------|
| 1: | 9.1 | ↗ |
| 2: | 9.9 | ↓ |
| 3: | 9.5 | ↗ |
| 4: | 9.1 | ↓ |
| 5: | 9.8 | ↑ |
| Serie | | 47.4 |
| Total | | 236.9 |

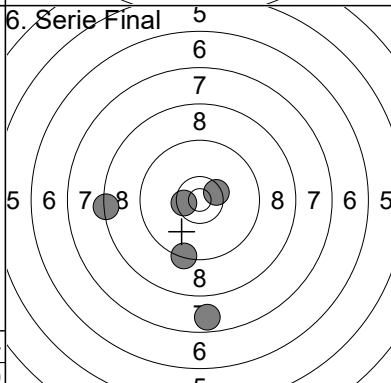

| | | |
|-------|-------|-------|
| 1: | 10.5x | ← |
| 2: | 10.5x | → |
| 3: | 8.4 | ← |
| 4: | 7.7 | ↓ |
| 5: | 9.4 | ↓ |
| Serie | | 46.5 |
| Total | | 283.4 |

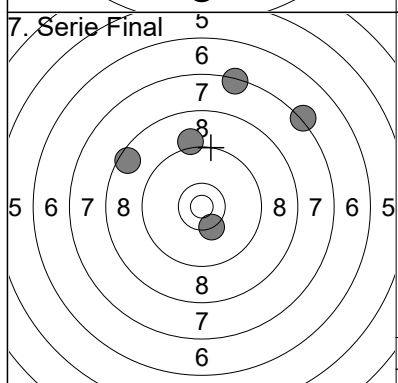

| | | |
|-------|-------|-------|
| 1: | 9.1 | ↑ |
| 2: | 10.3x | ↓ |
| 3: | 7.2 | ↗ |
| 4: | 7.4 | ↑ |
| 5: | 8.6 | ↗ |
| Serie | | 42.6 |
| Total | | 326.0 |

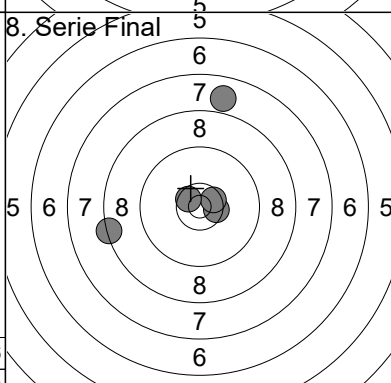

| | | |
|-------|-------|-------|
| 1: | 8.4 | ← |
| 2: | 10.5x | → |
| 3: | 10.5x | ↗ |
| 4: | 7.9 | ↑ |
| 5: | 10.6x | ↗ |
| Serie | | 47.9 |
| Total | | 373.9 |

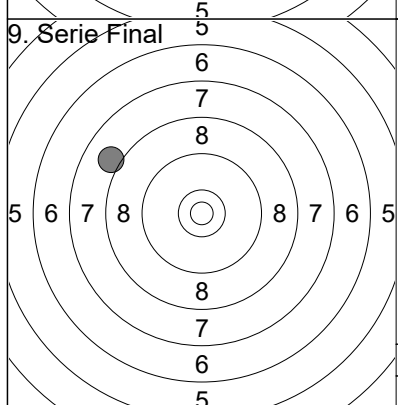

| | | |
|-------|-----|-------|
| 1: | 8.1 | ↖ |
| Serie | | 8.1 |
| Total | | 382.0 |

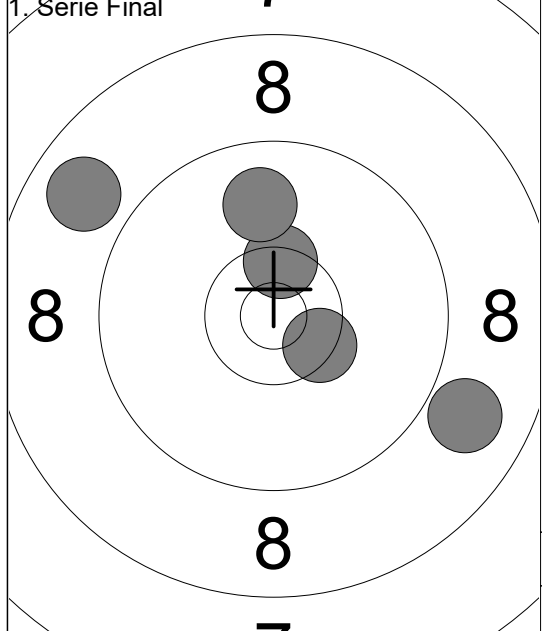

| | |
|------------|---------|
| 1: | 8.8 ↖ |
| 2: | 8.9 → |
| 3: | 10.4x ↗ |
| 4: | 9.9 ↑ |
| 5: | 10.4x ↘ |
| Serie 48.4 | |
| Total 48.4 | |

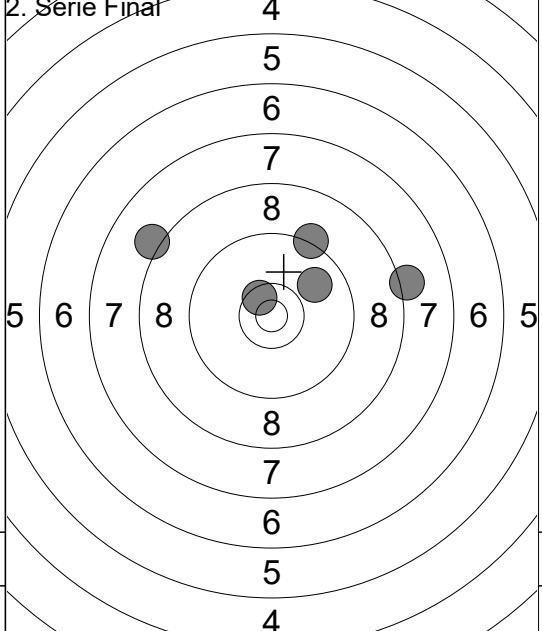

| | |
|------------|---------|
| 1: | 8.1 ↖ |
| 2: | 9.9 ↗ |
| 3: | 9.3 ↑ |
| 4: | 10.5x ↘ |
| 5: | 8.2 → |
| Serie 46.0 | |
| Total 94.4 | |

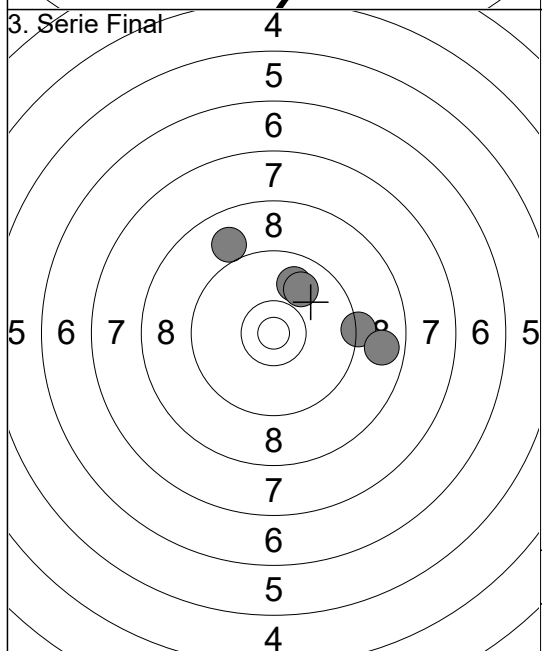

| | |
|-------------|-------|
| 1: | 9.9 ↑ |
| 2: | 9.3 → |
| 3: | 8.8 → |
| 4: | 9.0 ↗ |
| 5: | 9.9 ↗ |
| Serie 46.9 | |
| Total 141.3 | |

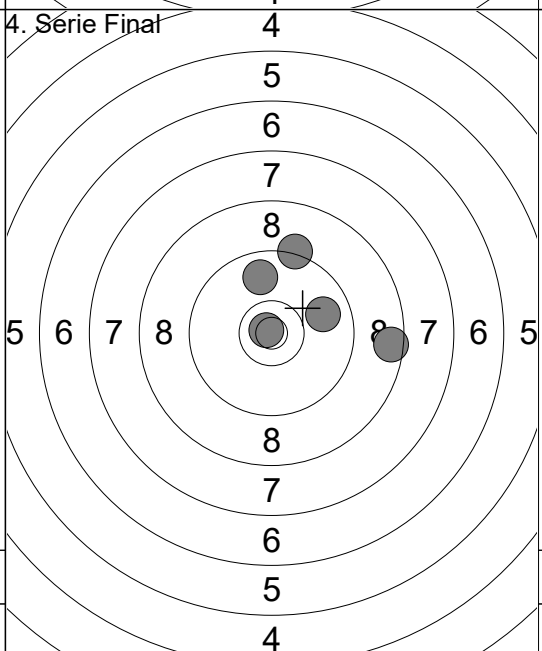

| | |
|-------------|---------|
| 1: | 9.9 → |
| 2: | 9.2 ↑ |
| 3: | 9.8 ↑ |
| 4: | 10.8x ↘ |
| 5: | 8.5 → |
| Serie 48.2 | |
| Total 189.5 | |

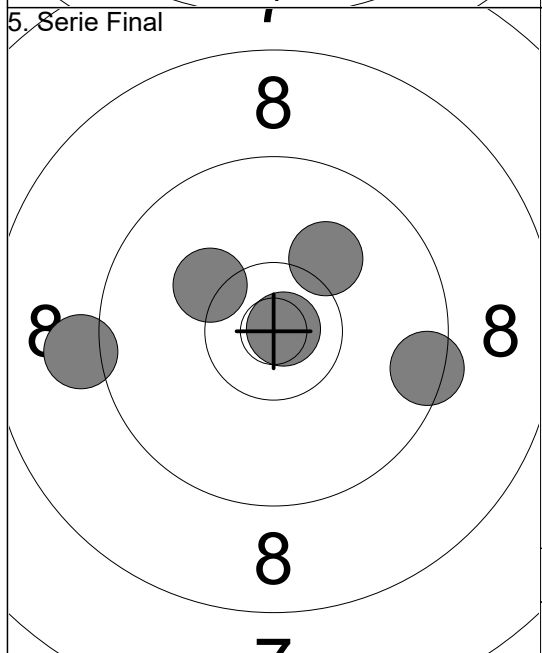

| | |
|-------------|---------|
| 1: | 10.2 ↖ |
| 2: | 10.9x → |
| 3: | 9.5 → |
| 4: | 10.1 ↗ |
| 5: | 9.1 ← |
| Serie 49.8 | |
| Total 239.3 | |

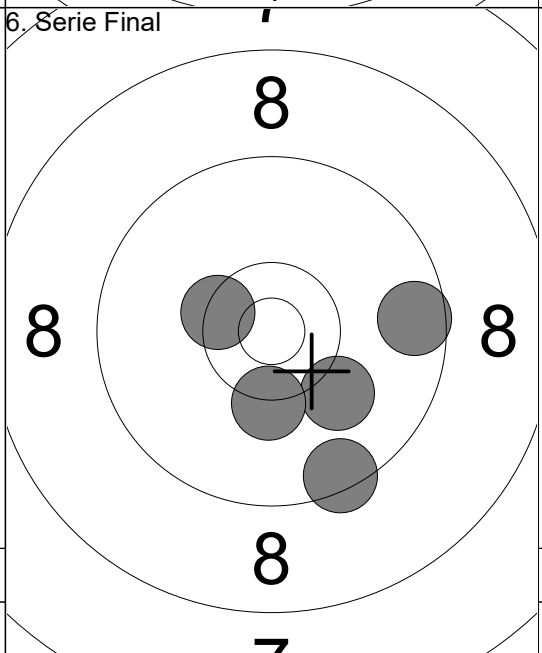

| | |
|-------------|---------|
| 1: | 10.4x ↘ |
| 2: | 9.6 → |
| 3: | 10.1 ↘ |
| 4: | 10.3 ↓ |
| 5: | 9.4 ↓ |
| Serie 49.8 | |
| Total 289.1 | |

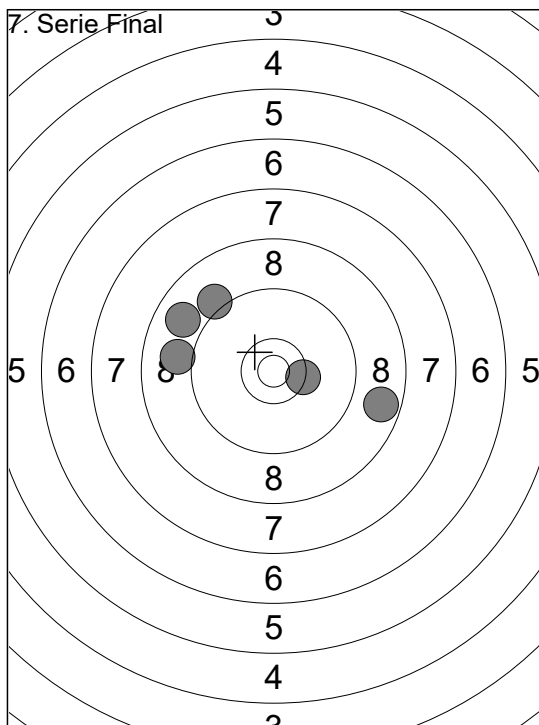

- 1: 8.7 →
- 2: 9.1 ↗
- 3: 9.0 ←
- 4: 8.9 ↖
- 5: 10.4x➤

| | |
|-------|-------|
| Serie | 46.1 |
| Total | 335.2 |

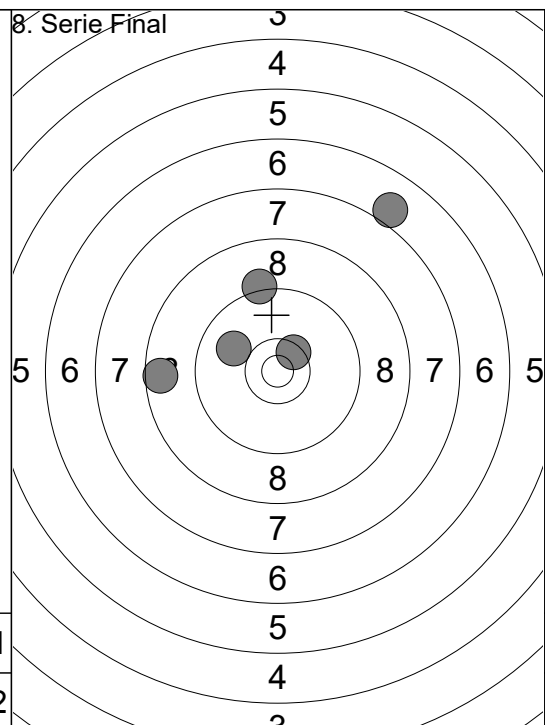

- 1: 10.0 ↖
- 2: 8.6 ←
- 3: 9.2 ↑
- 4: 7.0 ↗
- 5: 10.5x↗

| | |
|-------|-------|
| Serie | 45.3 |
| Total | 380.5 |

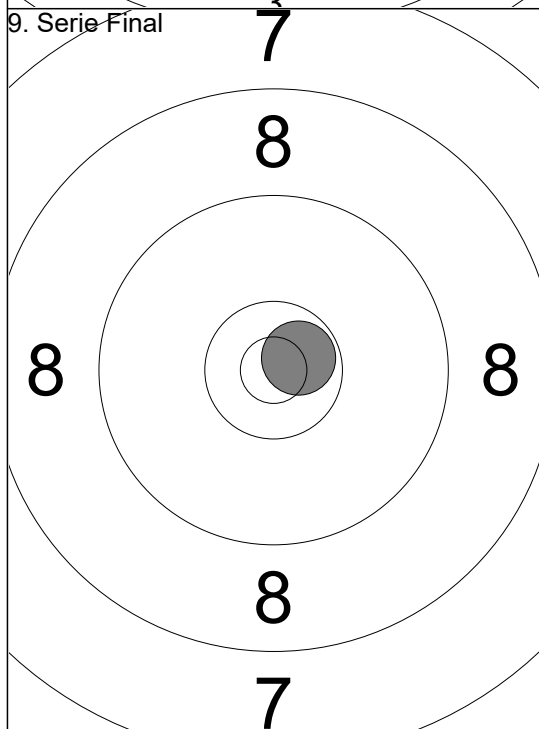

- 1: 10.7x➤

| | |
|-------|-------|
| Serie | 10.7 |
| Total | 391.2 |

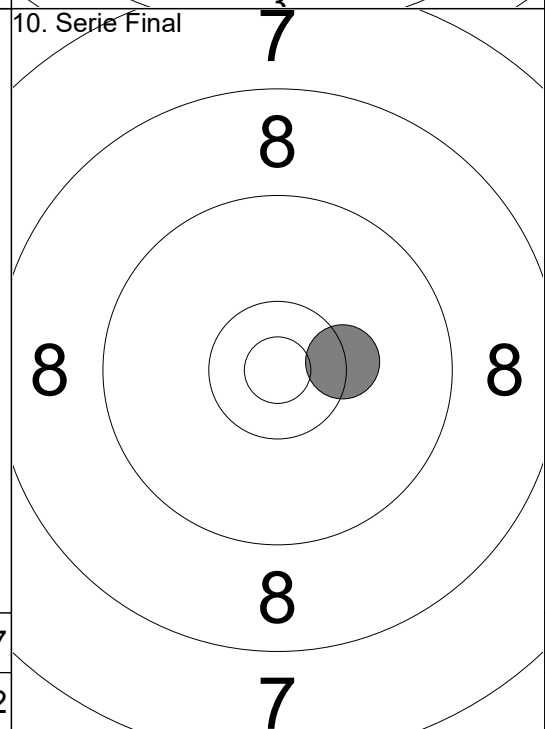

- 1: 10.3x➤

| | |
|-------|-------|
| Serie | 10.3 |
| Total | 401.5 |

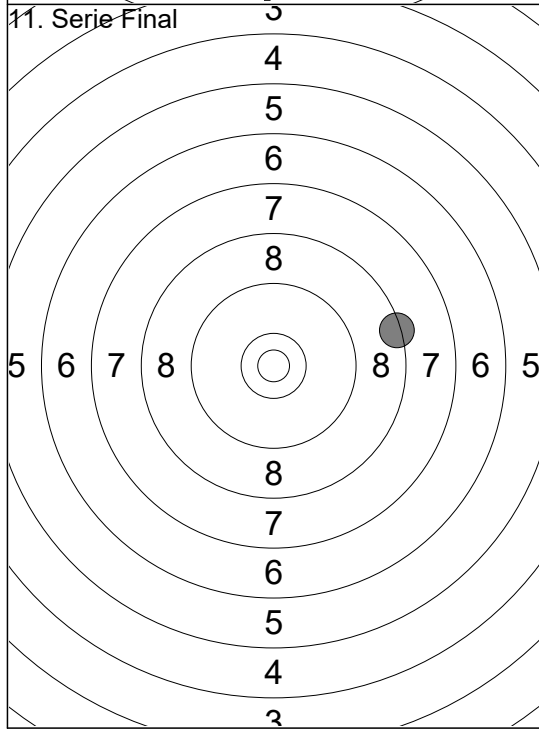

- 1: 8.4 →

| | |
|-------|-------|
| Serie | 8.4 |
| Total | 409.9 |

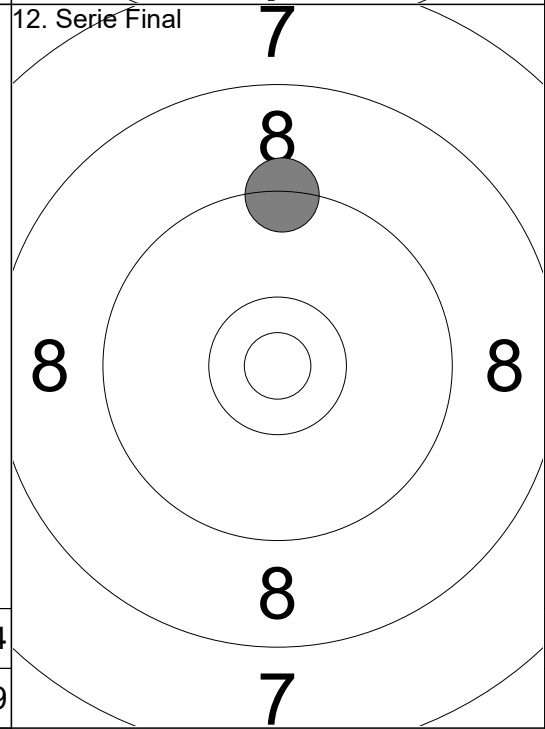

- 1: 9.3 ↑

| | |
|-------|-------|
| Serie | 9.3 |
| Total | 419.2 |

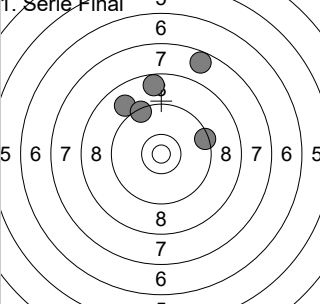
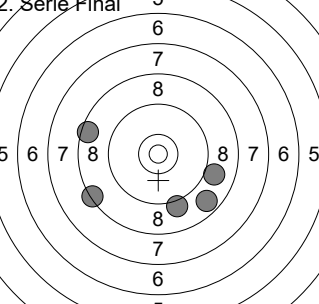
| | | | |
|---|--|---|--|
| 1. Serie Final  | 1: 8.9 ↖ 2: 9.4 → 3: 7.7 ↗ 4: 9.4 ↗ 5: 8.7 ↑ | 2. Serie Final  | 1: 8.4 ↖ 2: 8.5 ↗ 3: 8.7 ↘ 4: 9.1 ↘ 5: 9.0 ↘ |
| Serie 44.1 Total 44.1 | | Serie 43.7 Total 87.8 | |

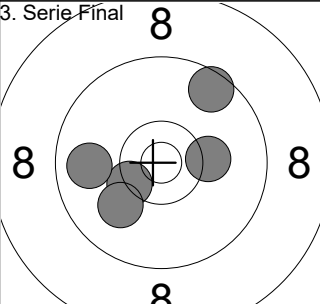
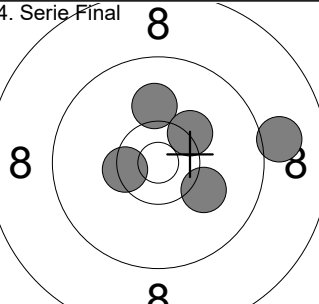
| | | | |
|---|--|---|---|
| 3. Serie Final  | 1: 10.2 → 2: 9.6 ↗ 3: 10.4x ↘ 4: 10.0 ↘ 5: 9.8 ← | 4. Serie Final  | 1: 9.0 → 2: 10.1 ↑ 3: 10.3 ↗ 4: 10.4x ← 5: 10.1 ↘ |
| Serie 50.0 Total 137.8 | | Serie 49.9 Total 187.7 | |

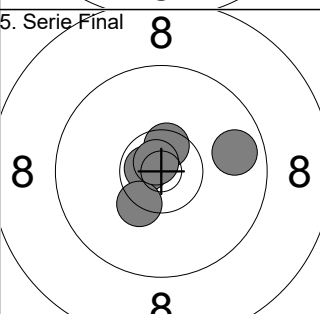
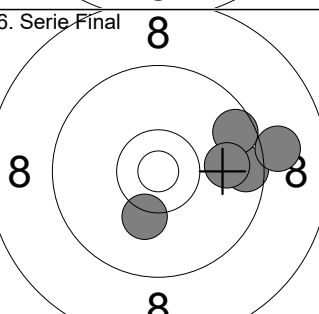
| | | | |
|--|--|--|---|
| 5. Serie Final  | 1: 10.5x ↑ 2: 10.7x ← 3: 10.3x ↘ 4: 10.8x ↗ 5: 9.8 → | 6. Serie Final  | 1: 10.2 ↓ 2: 9.6 → 3: 9.6 ↗ 4: 9.9 → 5: 9.1 → |
| Serie 52.1 Total 239.8 | | Serie 48.4 Total 288.2 | |

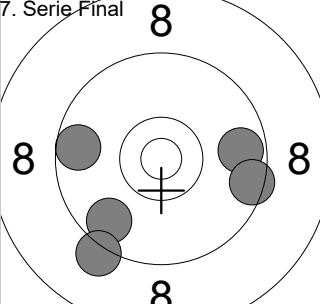
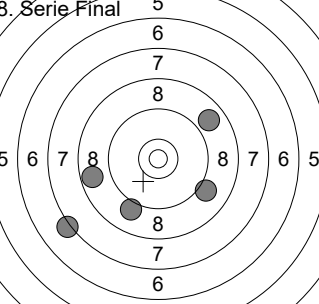
| | | | |
|---|--|---|--|
| 7. Serie Final  | 1: 9.7 ↘ 2: 9.7 ↘ 3: 9.6 ← 4: 9.5 ↗ 5: 9.2 ↓ | 8. Serie Final  | 1: 9.0 ↓ 2: 7.2 ↘ 3: 8.9 ↗ 4: 9.0 ↘ 5: 8.7 ← |
| Serie 47.7 Total 335.9 | | Serie 42.8 Total 378.7 | |

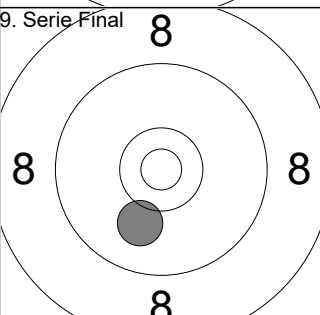
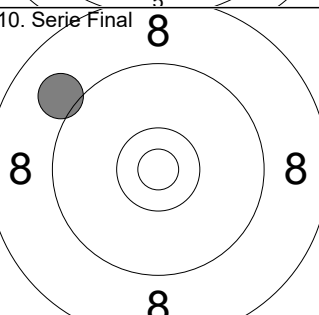
| | | | |
|---|-----------|--|----------|
| 9. Serie Final  | 1: 10.0 ↓ | 10. Serie Final  | 1: 9.0 ↖ |
| Serie 10.0 Total 388.7 | | Serie 9.0 Total 397.7 | |

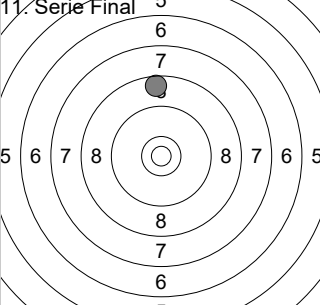
| | | | |
|--|----------|--|--|
| 11. Serie Final  | 1: 8.6 ↑ | | |
| Serie 8.6 Total 406.3 | | | |

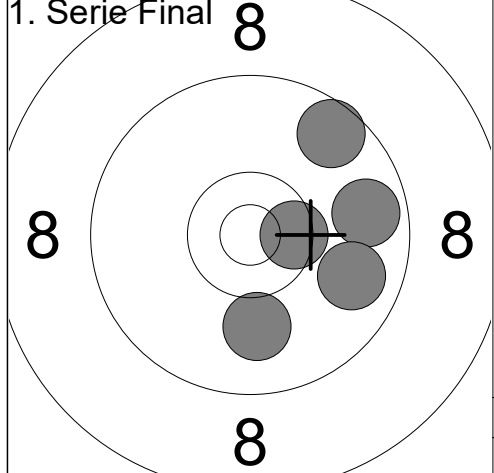

| | | |
|-------|-------|------|
| 1: | 9.6 | ↗ |
| 2: | 9.7 | → |
| 3: | 9.8 | → |
| 4: | 10.5x | → |
| 5: | 10.0 | ↓ |
| Serie | | 49.6 |
| Total | | 49.6 |

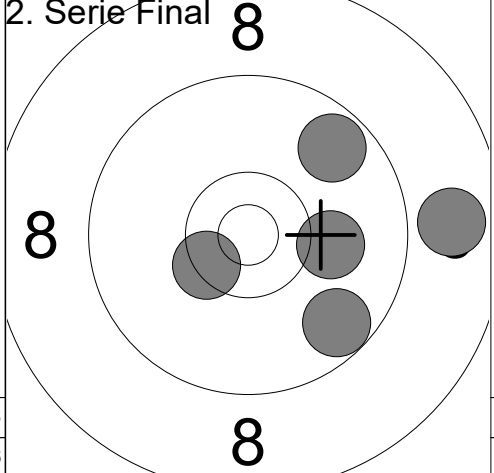

| | | |
|-------|-------|------|
| 1: | 8.8 | → |
| 2: | 9.7 | ↘ |
| 3: | 10.4x | ↙ |
| 4: | 9.7 | ↗ |
| 5: | 10.1 | → |
| Serie | | 48.7 |
| Total | | 98.3 |

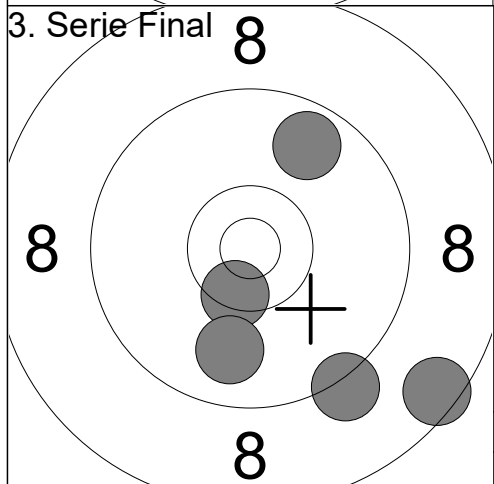

| | | |
|-------|-------|-------|
| 1: | 9.2 | ↘ |
| 2: | 10.5x | ↘ |
| 3: | 8.5 | ↘ |
| 4: | 9.7 | ↗ |
| 5: | 9.9 | ↓ |
| Serie | | 47.8 |
| Total | | 146.1 |

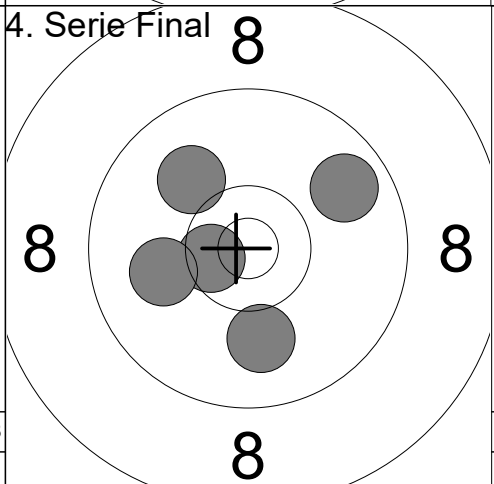

| | | |
|-------|-------|-------|
| 1: | 10.6x | ← |
| 2: | 10.0 | ↓ |
| 3: | 10.0 | ← |
| 4: | 10.0 | ↗ |
| 5: | 9.8 | ↗ |
| Serie | | 50.4 |
| Total | | 196.5 |

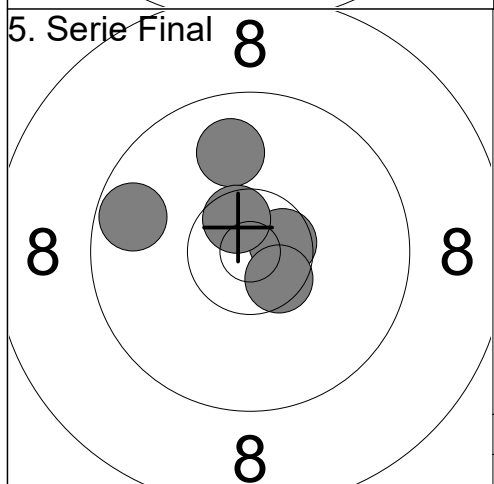

| | | |
|-------|-------|-------|
| 1: | 9.7 | ← |
| 2: | 10.6x | → |
| 3: | 9.9 | ↑ |
| 4: | 10.5x | ↘ |
| 5: | 10.6x | ↗ |
| Serie | | 51.3 |
| Total | | 247.8 |

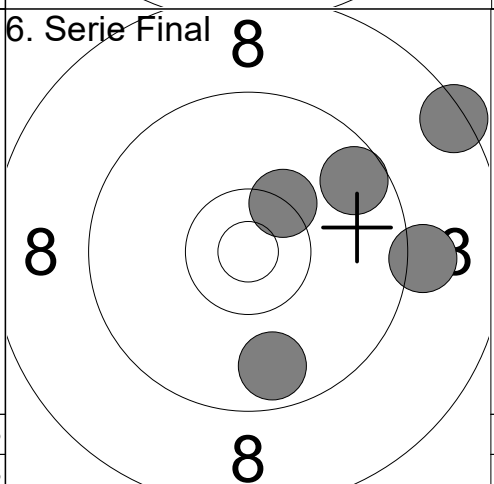

| | | |
|-------|-------|-------|
| 1: | 9.7 | ↓ |
| 2: | 9.1 | → |
| 3: | 9.6 | ↗ |
| 4: | 8.4 | ↗ |
| 5: | 10.3x | ↗ |
| Serie | | 47.1 |
| Total | | 294.9 |

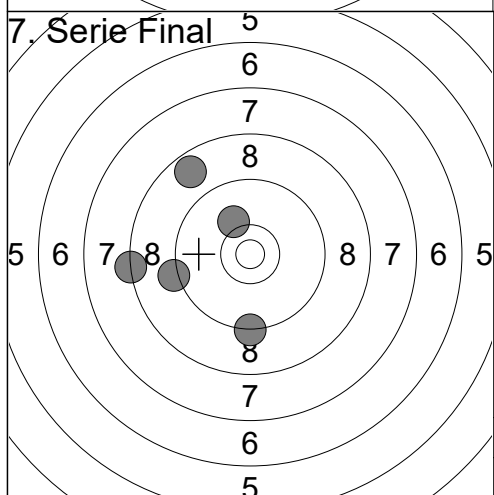

| | | |
|-------|------|-------|
| 1: | 9.3 | ↓ |
| 2: | 8.3 | ← |
| 3: | 9.2 | ← |
| 4: | 10.2 | ↗ |
| 5: | 8.7 | ↗ |
| Serie | | 45.7 |
| Total | | 340.6 |

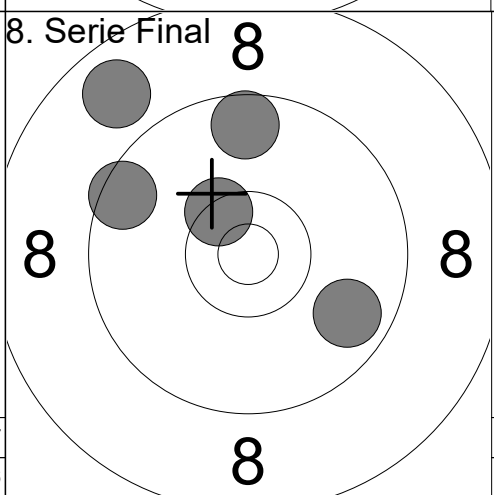

| | | |
|-------|-------|-------|
| 1: | 9.6 | ↑ |
| 2: | 8.8 | ↗ |
| 3: | 10.4x | ↗ |
| 4: | 9.8 | ↘ |
| 5: | 9.5 | ↗ |
| Serie | | 48.1 |
| Total | | 388.7 |

9. Serie Final

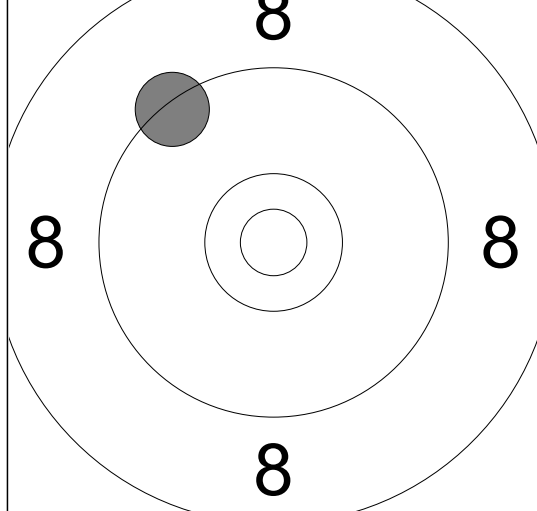

| | |
|-------|-------|
| Serie | 9.4 |
| Total | 398.1 |

10. Serie Final

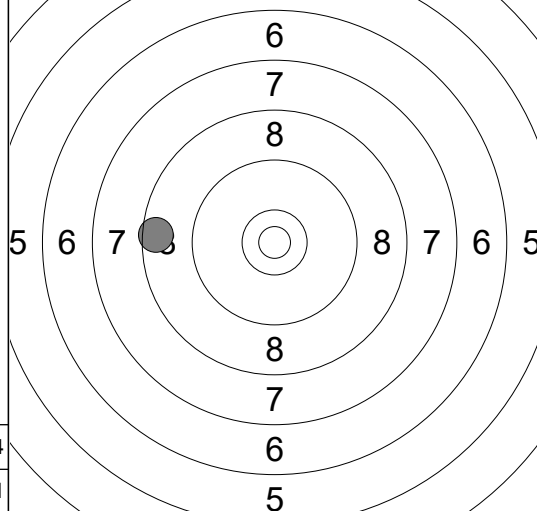

| | |
|-------|-------|
| Serie | 8.6 |
| Total | 406.7 |

11. Serie Final

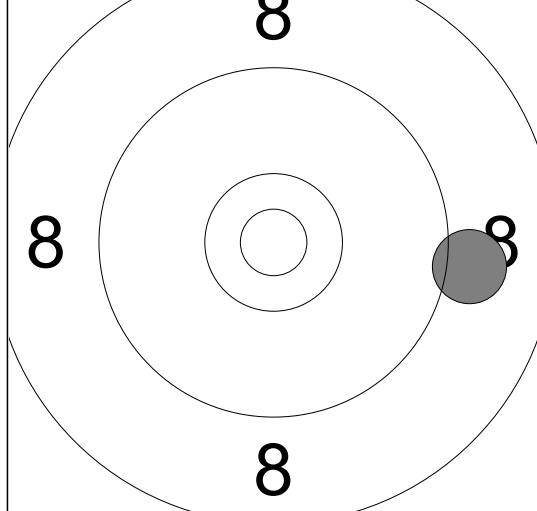

| | |
|-------|-------|
| Serie | 9.1 |
| Total | 415.8 |

12. Serie Final

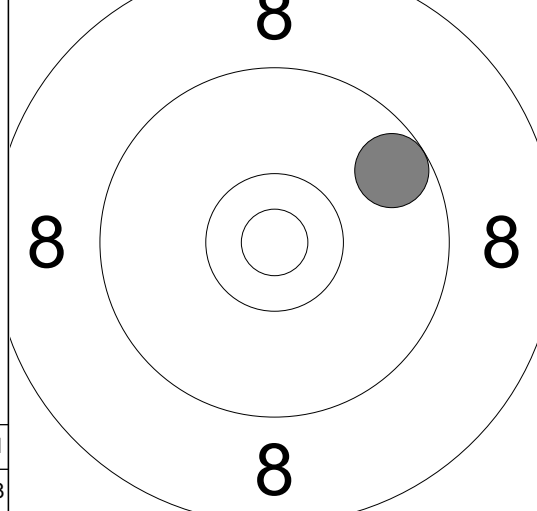

| | |
|-------|-------|
| Serie | 9.7 |
| Total | 425.5 |

13. Serie Final

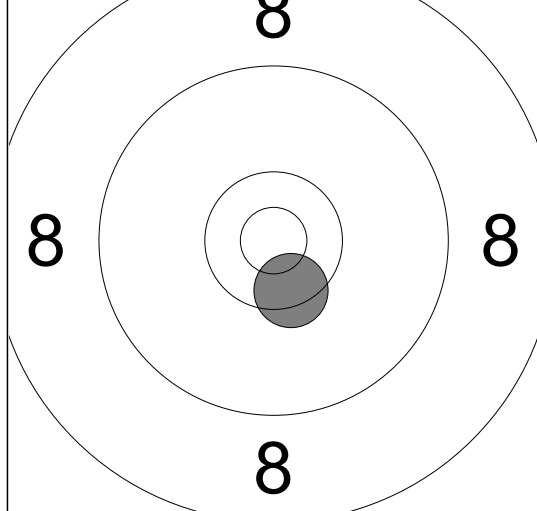

| | |
|-------|-------|
| Serie | 10.5 |
| Total | 436.0 |