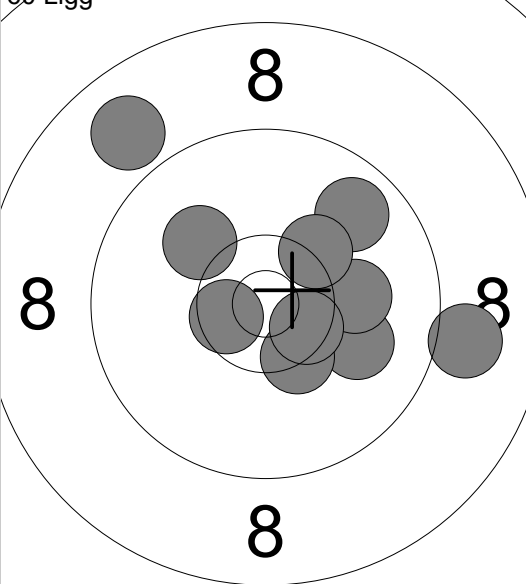
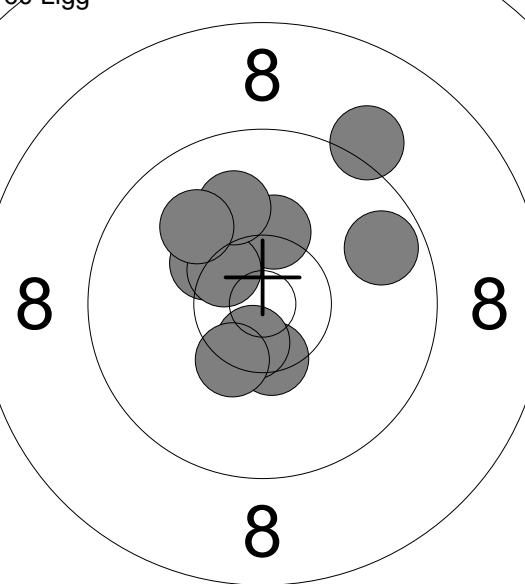
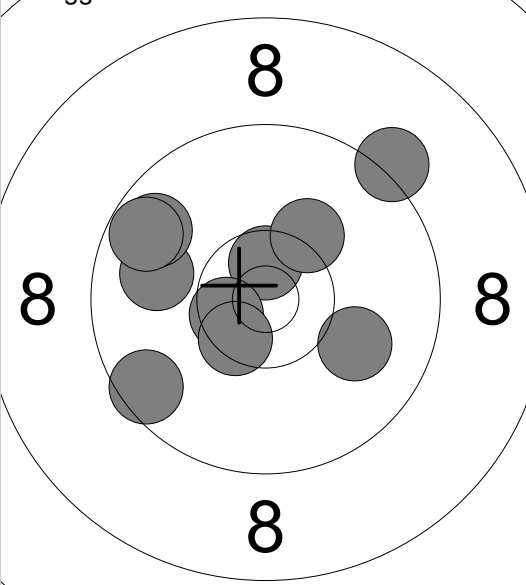
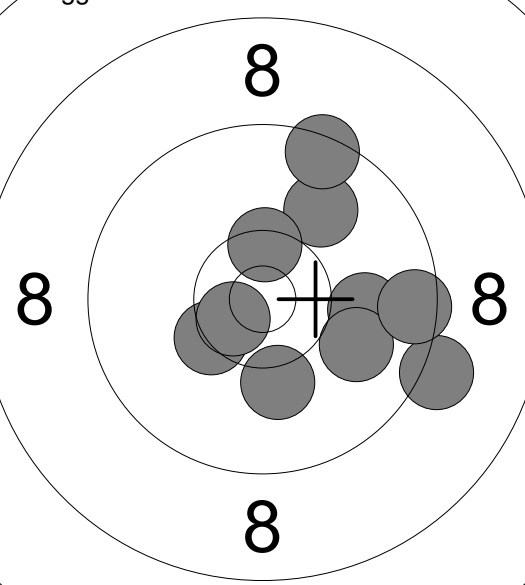
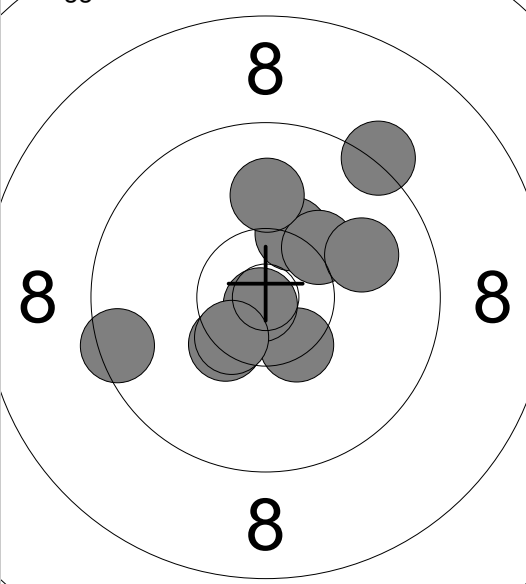
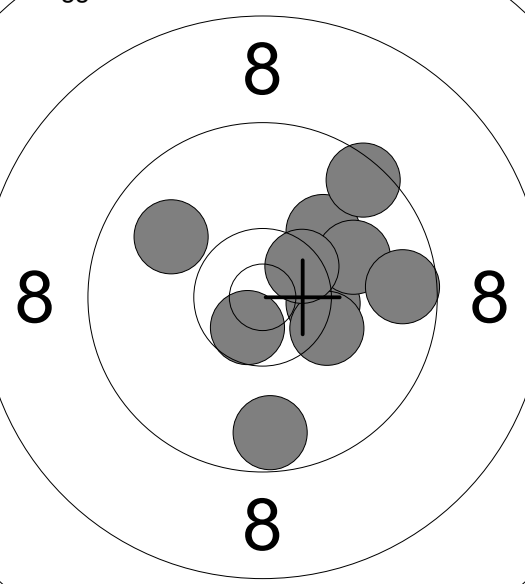
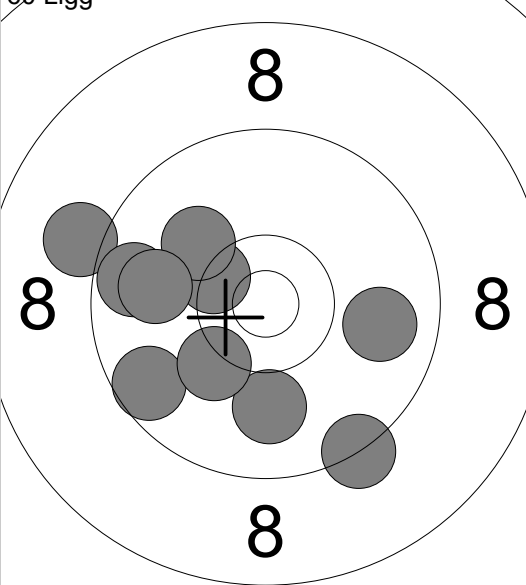
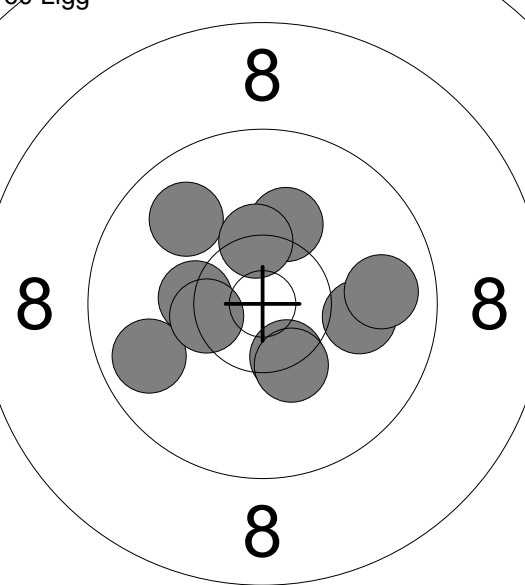
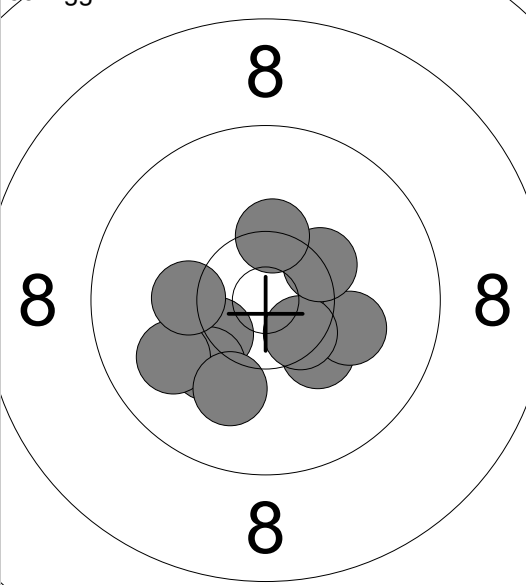
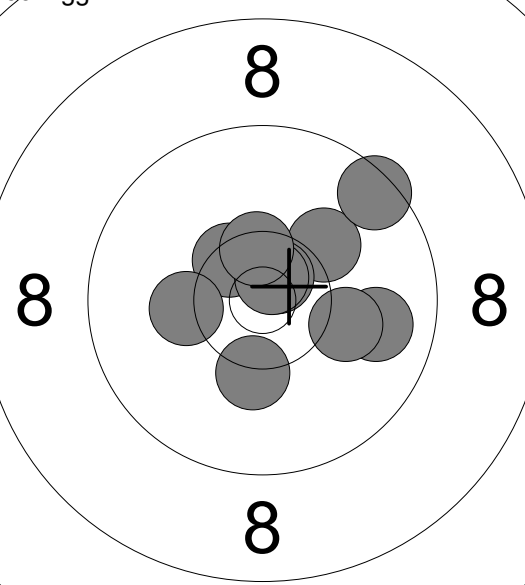
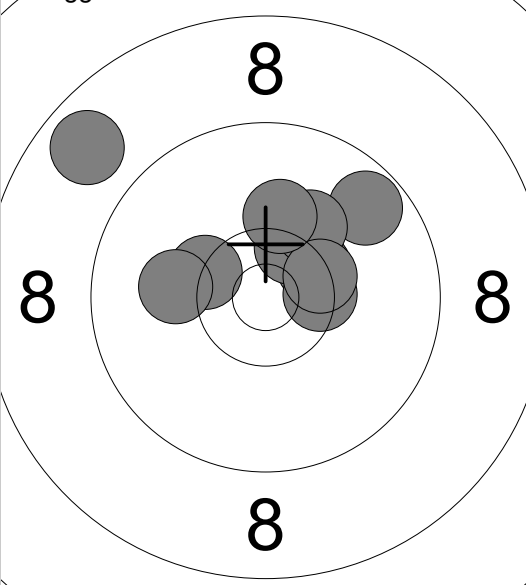
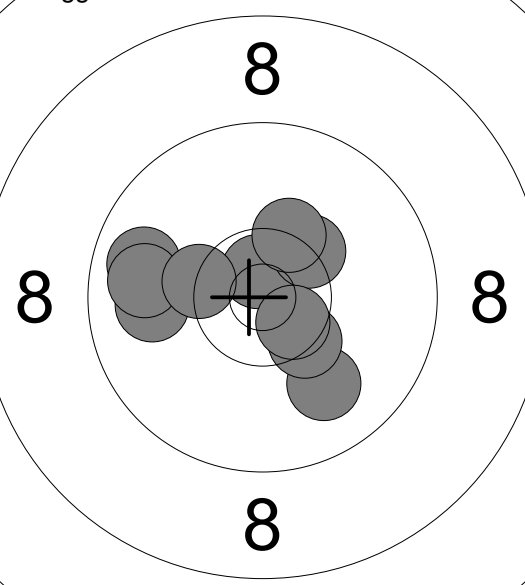

<p>60 Ligg</p> 	<p>1: 10.1 ↖                  2: 10.0 →                  3: 10.4x ↘                  4: 8.9 ↖                  5: 10.1 →                  6: 9.0 →                  7: 9.8 ↗                  8: 10.6x ↙                  9: 10.5x ↘                  10: 10.3 ↗</p> <p>Serie 99.7 Total 99.7</p>	<p>60 Ligg</p> 	<p>11: 10.4x ↘                  12: 9.7 →                  13: 10.6x ↘                  14: 10.3x ↘                  15: 10.3 ↑                  16: 10.3x ↘                  17: 10.5x ↘                  18: 10.0 ↑                  19: 10.0 ↖                  20: 9.1 ↗</p> <p>Serie 101.2 Total 200.9</p>
---	---	---	---

<p>60 Ligg</p> 	<p>21: 9.9 ←                  22: 10.6x ↑                  23: 10.6x ↙                  24: 9.6 ↙                  25: 10.2 ↗                  26: 9.7 ↖                  27: 9.7 ↖                  28: 9.2 ↗                  29: 10.5x ↘                  30: 10.0 →</p> <p>Serie 100.0 Total 300.9</p>	<p>60 Ligg</p> 	<p>31: 9.2 →                  32: 10.3x ↙                  33: 9.9 ↗                  34: 10.2 ↓                  35: 10.0 →                  36: 10.0 →                  37: 9.5 →                  38: 10.6x ↙                  39: 10.4x ↑                  40: 9.4 ↗</p> <p>Serie 99.5 Total 400.4</p>
--	--	--	--

<p>60 Ligg</p> 	<p>41: 10.4x ↘                  42: 10.4x ↘                  43: 10.9x ↘                  44: 10.5x ↘                  45: 9.3 ↗                  46: 10.3x ↑                  47: 10.3 ↗                  48: 9.5 ←                  49: 10.0 →                  50: 10.0 ↑</p> <p>Serie 101.6 Total 502.0</p>	<p>60 Ligg</p> 	<p>51: 10.4x →                  52: 10.1 ↗                  53: 9.7 ↓                  54: 9.5 ↗                  55: 10.6x ↘                  56: 10.0 →                  57: 10.3 →                  58: 9.9 ↖                  59: 9.6 →                  60: 10.5x ↗</p> <p>Serie 100.6 Total 602.6</p>
---	---	---	---

<p>60 Ligg</p>  <p style="text-align: center;">8</p>	<p>1: 9.9 →</p> <p>2: 9.3 ↓</p> <p>3: 10.4 ✕</p> <p>4: 9.6 ↙</p> <p>5: 9.1 ←</p> <p>6: 9.7 ←</p> <p>7: 10.1 ↖</p> <p>8: 9.9 ←</p> <p>9: 10.0 ↓</p> <p>10: 10.2 ↙</p> <hr/> <p>Serie 98.2</p> <hr/> <p>Total 98.2</p>	<p>60 Ligg</p>  <p style="text-align: center;">8</p>	<p>11: 10.0 →</p> <p>12: 10.2 ↑</p> <p>13: 9.8 →</p> <p>14: 9.8 ←</p> <p>15: 9.9 ↖</p> <p>16: 10.3 ✕</p> <p>17: 10.4x ↓</p> <p>18: 10.4x ↑</p> <p>19: 10.4x ✕</p> <p>20: 10.3x ↓</p> <hr/> <p>Serie 101.5</p> <hr/> <p>Total 199.7</p>
<p>60 Ligg</p>  <p style="text-align: center;">8</p>	<p>21: 10.3 ↓</p> <p>22: 10.1 →</p> <p>23: 10.4 ✕</p> <p>24: 10.1 ↙</p> <p>25: 9.9 ↙</p> <p>26: 10.0 ↓</p> <p>27: 10.2 ←</p> <p>28: 10.5x ↓</p> <p>29: 10.3x ↗</p> <p>30: 10.3x ↑</p> <hr/> <p>Serie 102.1</p> <hr/> <p>Total 301.8</p>	<p>60 Ligg</p>  <p style="text-align: center;">8</p>	<p>31: 10.2 ↗</p> <p>32: 9.9 →</p> <p>33: 10.5x ✕</p> <p>34: 10.7x ↗</p> <p>35: 10.7x ↗</p> <p>36: 9.5 ↗</p> <p>37: 10.1 →</p> <p>38: 10.5x ↑</p> <p>39: 10.2 ←</p> <p>40: 10.3 ↓</p> <hr/> <p>Serie 102.6</p> <hr/> <p>Total 404.4</p>
<p>60 Ligg</p>  <p style="text-align: center;">8</p>	<p>41: 10.4x ↗</p> <p>42: 10.4x →</p> <p>43: 10.3x ✕</p> <p>44: 10.4x ↗</p> <p>45: 8.8 ↖</p> <p>46: 10.1 ←</p> <p>47: 9.7 ↗</p> <p>48: 10.2 ↗</p> <p>49: 10.4x →</p> <p>50: 10.2 ↑</p> <hr/> <p>Serie 100.9</p> <hr/> <p>Total 505.3</p>	<p>60 Ligg</p>  <p style="text-align: center;">8</p>	<p>51: 9.9 ←</p> <p>52: 10.7x ↑</p> <p>53: 10.0 ↓</p> <p>54: 10.3x ↗</p> <p>55: 10.4x ↓</p> <p>56: 10.6x ↓</p> <p>57: 9.8 ←</p> <p>58: 10.3x ↑</p> <p>59: 9.8 ←</p> <p>60: 10.3x ✕</p> <hr/> <p>Serie 102.1</p> <hr/> <p>Total 607.4</p>

<p>60 Ligg</p>	<p>60 Ligg</p>
Serie 100.6	Serie 99.3
Total 100.6	Total 199.9

<p>60 Ligg</p>	<p>60 Ligg</p>
Serie 100.3	Serie 102.5
Total 300.2	Total 402.7

<p>60 Ligg</p>	<p>60 Ligg</p>
Serie 101.1	Serie 101.9
Total 503.8	Total 605.7

Skjutlag  
**5**

Tavla  
**7**

# Emanuel Söderlund

Grangården

Kristinehamn

05.05.2018

Trolltåffen/GP 2018

Trollhättans SKF

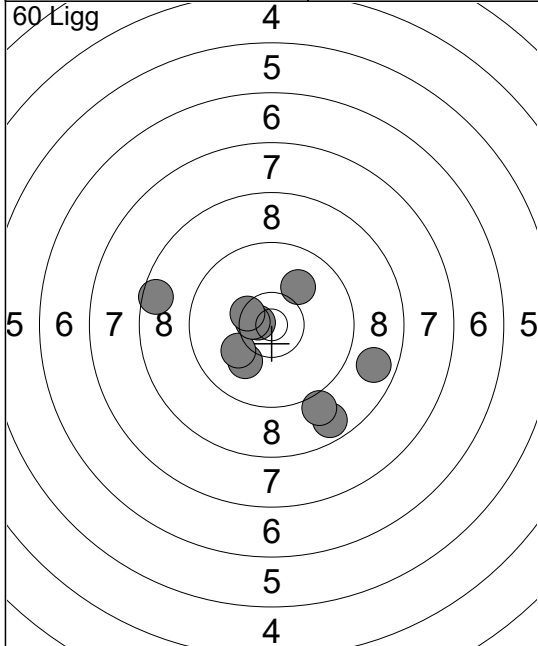

1:	10.7x
2:	8.8
3:	10.0
4:	8.6
5:	8.7
6:	10.0
7:	10.1
8:	10.6x
9:	9.0
10:	10.4x
Serie	96.9
Total	96.9

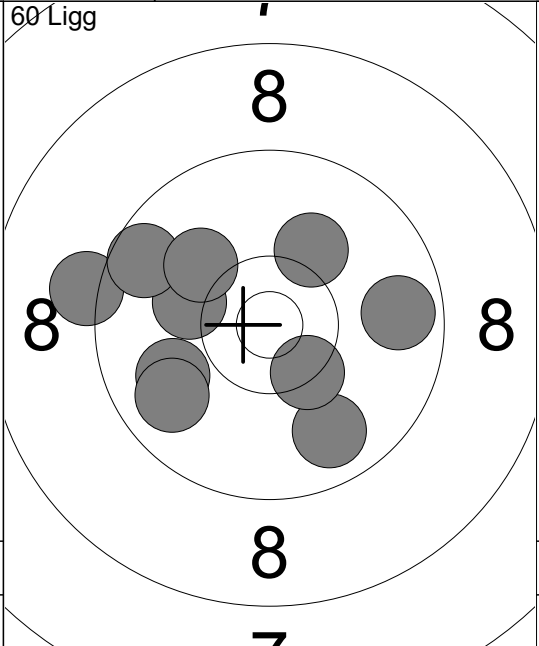

11:	10.2
12:	9.2
13:	9.9
14:	9.6
15:	9.8
16:	10.1
17:	9.8
18:	10.1
19:	10.4x
20:	9.7
Serie	98.8
Total	195.7

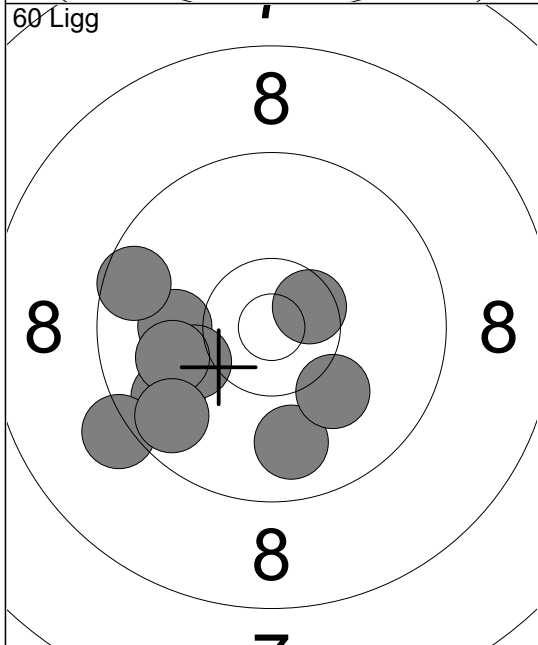

21:	9.9
22:	9.8
23:	10.0
24:	10.2
25:	9.2
26:	10.1
27:	10.0
28:	9.6
29:	9.7
30:	10.5x
Serie	99.0
Total	294.7

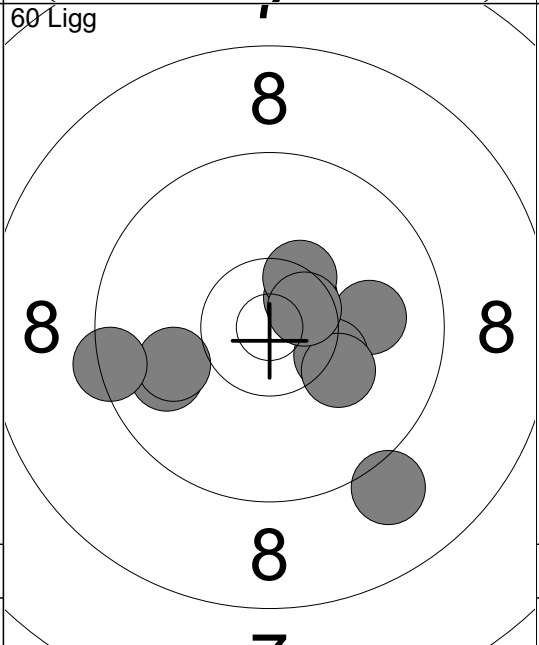

31:	9.9
32:	10.0
33:	10.5x
34:	9.4
35:	10.0
36:	9.1
37:	10.3x
38:	10.2
39:	10.4x
40:	10.6x
Serie	100.4
Total	395.1

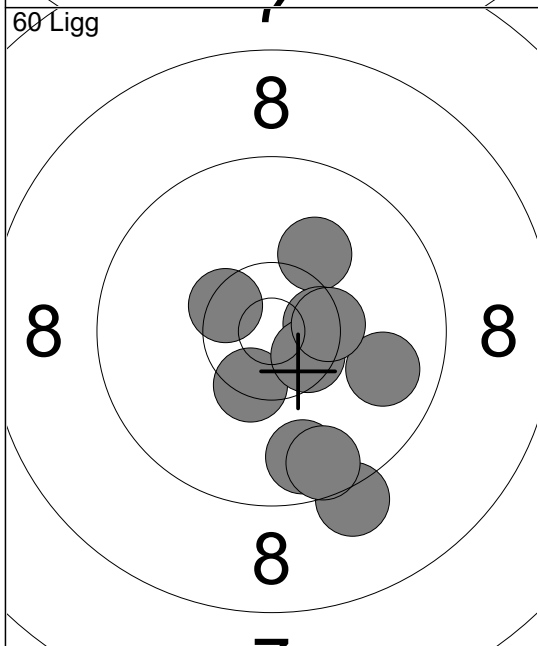

41:	9.8
42:	10.4x
43:	10.1
44:	10.5x
45:	10.5x
46:	9.2
47:	10.4x
48:	10.5x
49:	9.7
50:	9.6
Serie	100.7
Total	495.8

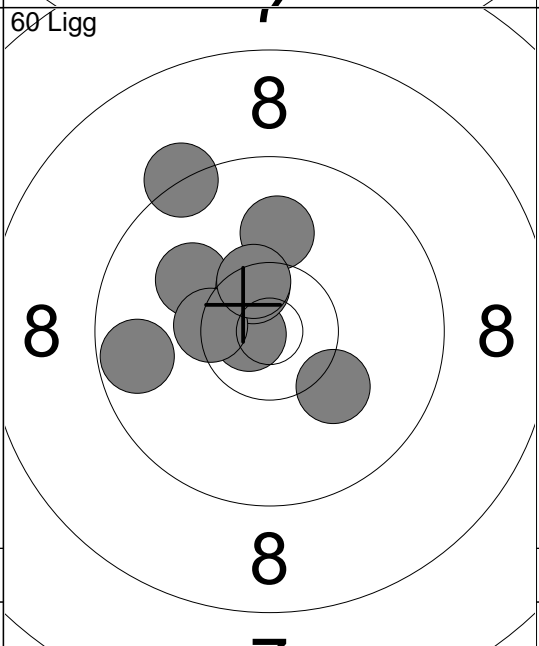

51:	10.0
52:	10.1
53:	10.6x
54:	10.2
55:	9.7
56:	9.3
57:	10.8x
58:	10.5x
59:	10.4x
60:	10.5x
Serie	102.1
Total	597.9

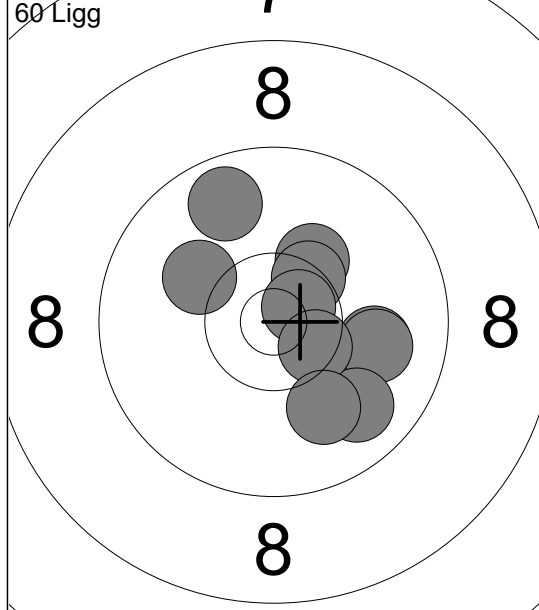

1:	10.3 ↗
2:	10.0 →
3:	10.0 →
4:	10.1 ↖
5:	10.4x ↗
6:	9.7 ↖
7:	10.7x ↗
8:	9.8 ↘
9:	10.5x ↘
10:	10.0 ↘
Serie 101.5	
Total 101.5	

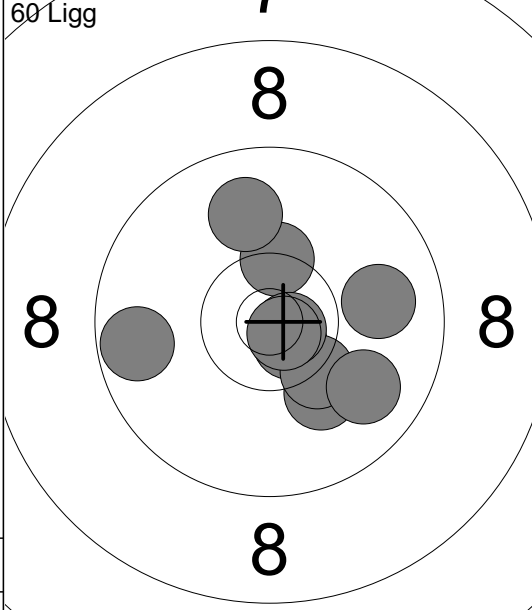

11:	10.1 ↘
12:	10.7x ↘
13:	9.7 ←
14:	10.3x ↘
15:	10.4x ↗
16:	9.9 ↖
17:	10.7x ↗
18:	9.9 →
19:	9.9 ↘
20:	10.8x ↘
Serie 102.4	
Total 203.9	

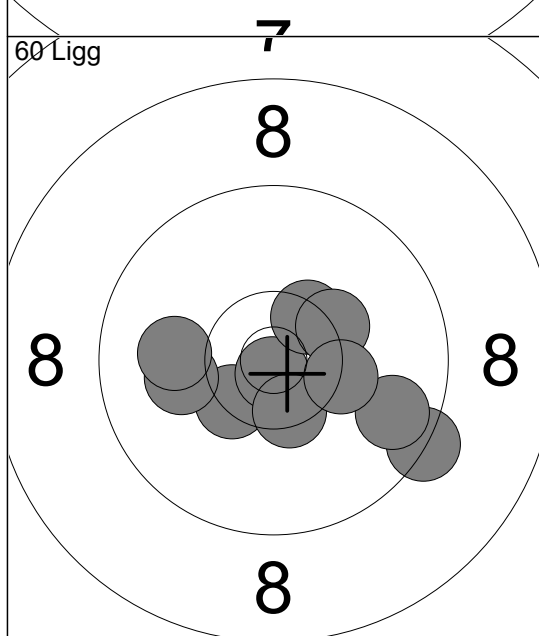

21:	9.3 ↘
22:	10.4x ↘
23:	10.1 ←
24:	10.8x ↘
25:	10.4x ↗
26:	10.5x ↘
27:	10.3x ↗
28:	9.7 →
29:	10.3x ↗
30:	10.0 ←
Serie 101.8	
Total 305.7	

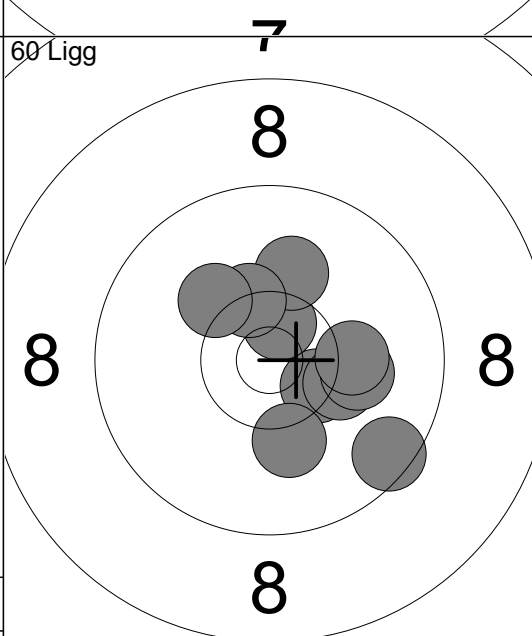

31:	10.4x ↗
32:	10.3 →
33:	10.6x ↗
34:	10.1 ↖
35:	10.4x ↗
36:	10.2 ↖
37:	10.2 ↘
38:	10.1 →
39:	9.5 ↘
40:	10.2 →
Serie 102.0	
Total 407.7	

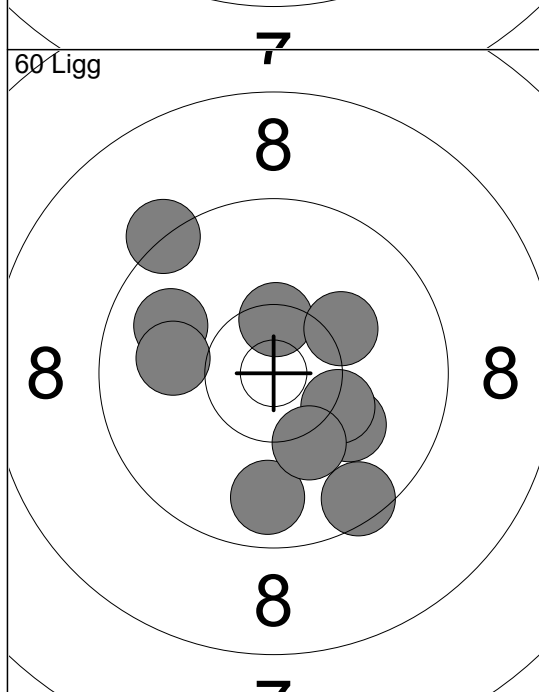

41:	10.1 →
42:	10.4x ↗
43:	10.2 ↗
44:	9.9 ↖
45:	10.0 ←
46:	9.8 ↘
47:	9.3 ↖
48:	10.3 →
49:	9.5 ↘
50:	10.2 ↘
Serie 99.7	
Total 507.4	

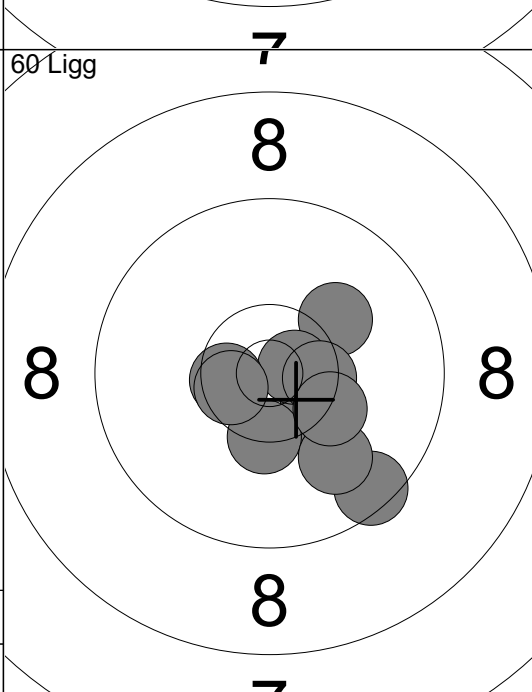

51:	10.2 ↗
52:	10.4x ↘
53:	9.5 ↘
54:	10.3x ↘
55:	10.7x ↗
56:	10.5x ↗
57:	10.5x ↖
58:	9.9 ↘
59:	10.3x ↘
60:	10.6x ↖
Serie 102.9	
Total 610.3	

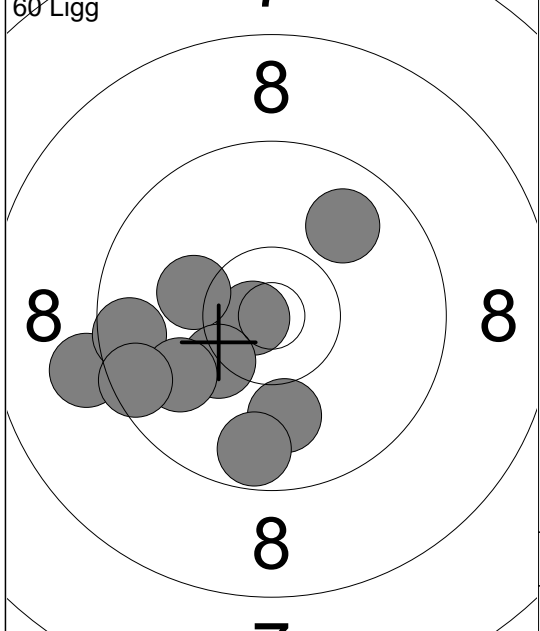

1:	9.1	←
2:	9.9	↗
3:	10.8	✕
4:	10.2	←
5:	9.6	←
6:	10.3	✕
7:	10.0	↓
8:	9.9	←
9:	9.5	←
10:	9.7	↓
Serie		99.0
Total		99.0

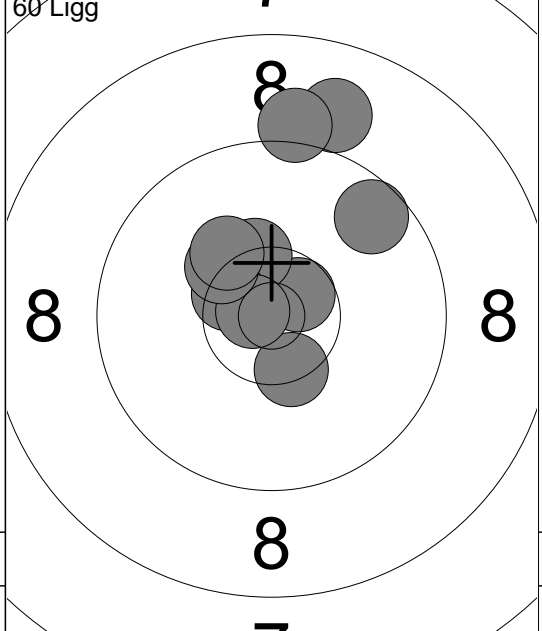

11:	10.6	↗
12:	10.4	↖
13:	9.6	↗
14:	10.5	✕
15:	9.0	↑
16:	10.4	↘
17:	10.8	✕
18:	10.3	✕
19:	9.1	↑
20:	10.2	↖
Serie		100.9
Total		199.9

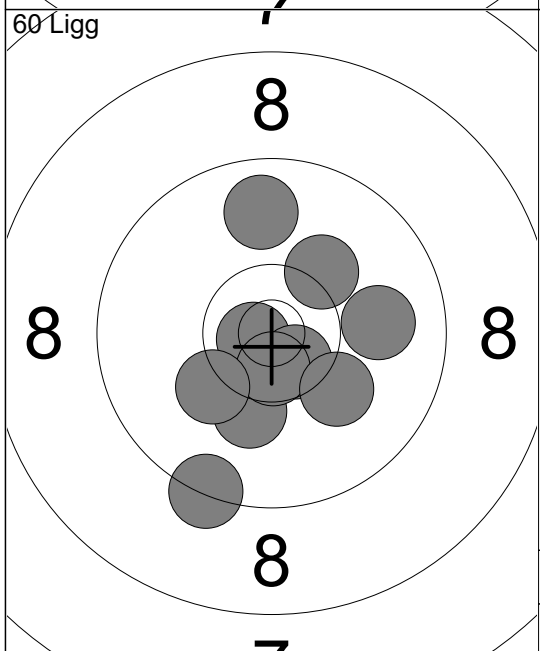

21:	10.8	✕
22:	10.6	↘
23:	10.2	↓
24:	10.6	↘
25:	10.1	↘
26:	9.9	→
27:	9.3	↓
28:	10.2	↘
29:	9.8	↑
30:	10.2	↗
Serie		101.7
Total		301.6

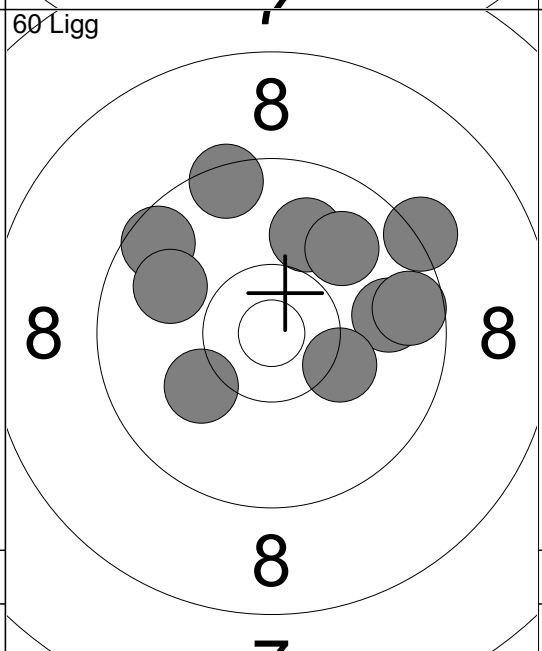

31:	9.8	→
32:	10.0	↑
33:	10.2	→
34:	9.3	↗
35:	9.9	↗
36:	9.6	→
37:	9.5	↑
38:	9.6	↖
39:	9.9	←
40:	10.1	↘
Serie		97.9
Total		399.5

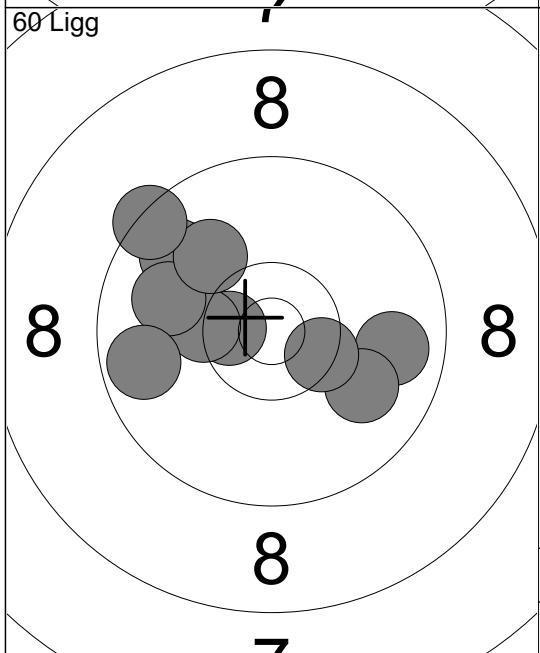

41:	10.6	✕
42:	9.8	→
43:	10.3	✕
44:	9.8	↗
45:	9.9	←
46:	10.0	↗
47:	10.0	→
48:	9.4	↖
49:	9.7	←
50:	10.4	↘
Serie		99.9
Total		499.4

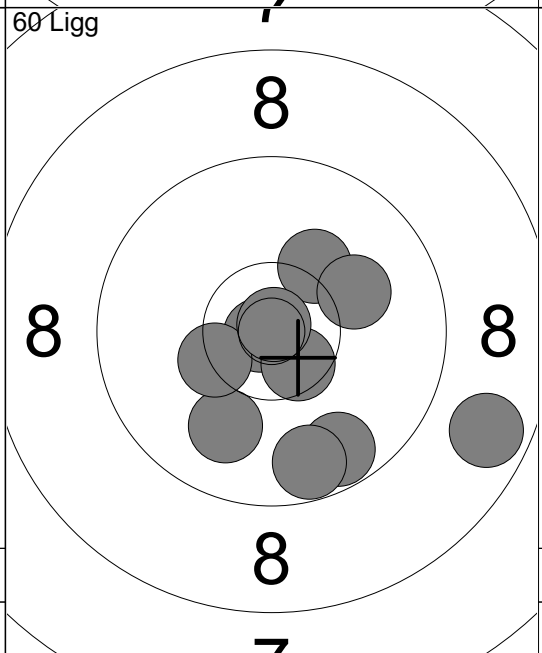

51:	10.8	✕
52:	10.0	↓
53:	10.6	↘
54:	9.7	↓
55:	8.7	→
56:	10.4	✕
57:	9.7	↓
58:	10.2	↗
59:	10.1	↗
60:	10.9	↗
Serie		101.1
Total		600.5

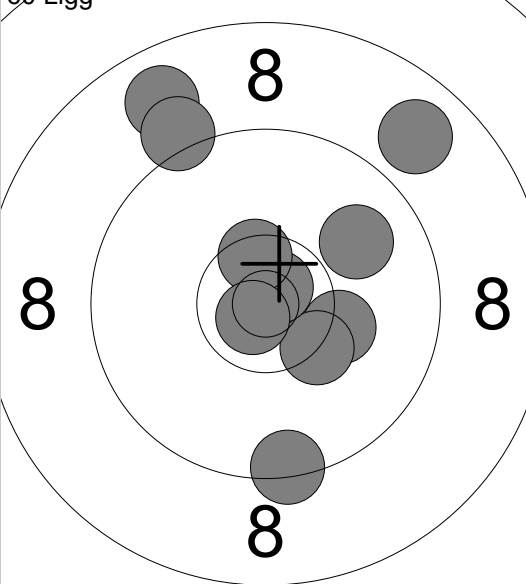
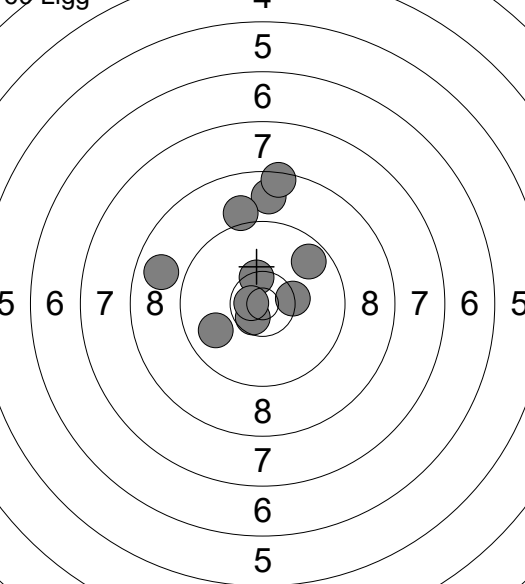
<p>60 Ligg</p> 	<p>1: 9.4 ↓</p> <p>2: 9.9 ↗</p> <p>3: 10.2 →</p> <p>4: 10.3x ↘</p> <p>5: 10.8x ↗</p> <p>6: 10.5x ↗</p> <p>7: 8.8 ↗</p> <p>8: 10.8x ↘</p> <p>9: 9.1 ↗</p> <p>10: 8.8 ↗</p> <p>Serie 98.6</p> <p>Total 98.6</p>	<p>60 Ligg</p>  <p>11: 9.7 ↗</p> <p>12: 10.4x ↗</p> <p>13: 8.8 ↑</p> <p>14: 8.4 ↑</p> <p>15: 10.6x ↘</p> <p>16: 8.8 ←</p> <p>17: 9.1 ↑</p> <p>18: 10.3x →</p> <p>19: 10.7x ←</p> <p>20: 9.9 ↙</p> <p>Serie 96.7</p> <p>Total 195.3</p>
---	---	--

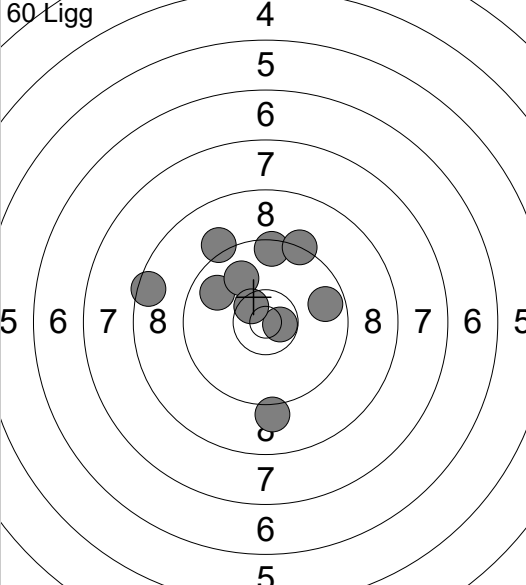
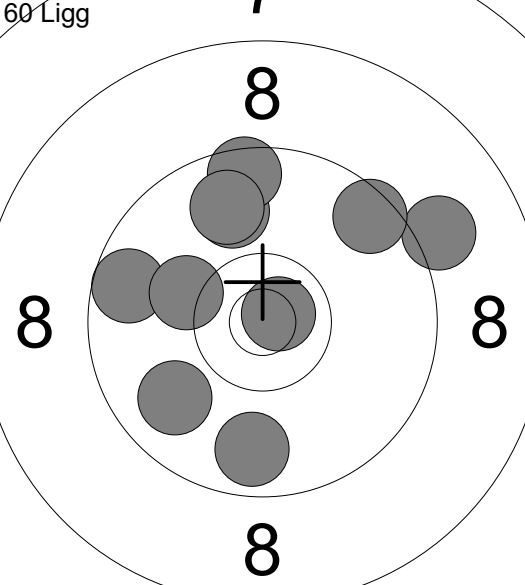
<p>60 Ligg</p> 	<p>21: 9.1 ↗</p> <p>22: 9.8 ←</p> <p>23: 9.7 →</p> <p>24: 10.7x →</p> <p>25: 9.9 ↗</p> <p>26: 9.5 ↑</p> <p>27: 8.5 ←</p> <p>28: 9.1 ↓</p> <p>29: 10.5x ↘</p> <p>30: 9.3 ↗</p> <p>Serie 96.1</p> <p>Total 291.4</p>	<p>60 Ligg</p>  <p>31: 9.1 ↗</p> <p>32: 9.5 ↗</p> <p>33: 10.8x ↗</p> <p>34: 9.6 ←</p> <p>35: 10.2 ←</p> <p>36: 9.9 ↑</p> <p>37: 9.7 ↓</p> <p>38: 9.5 ↑</p> <p>39: 9.9 ↙</p> <p>40: 9.8 ↗</p> <p>Serie 98.0</p> <p>Total 389.4</p>
--	--	--

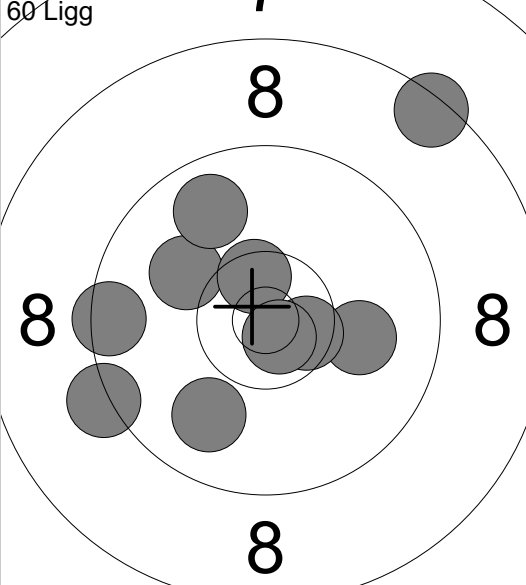
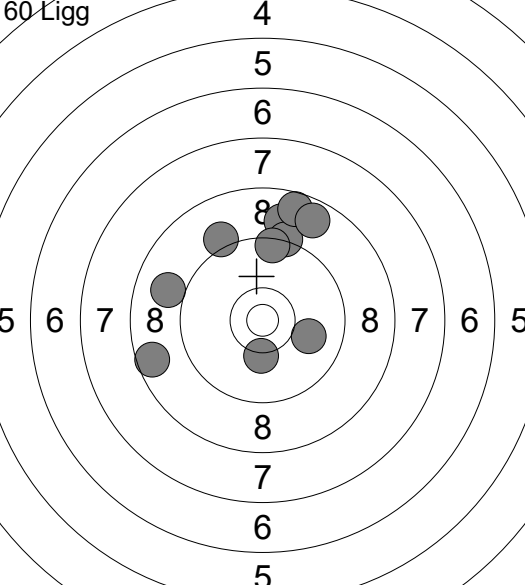
<p>60 Ligg</p> 	<p>41: 10.1 ←</p> <p>42: 10.5x ↗</p> <p>43: 8.4 ↗</p> <p>44: 9.9 ↙</p> <p>45: 10.1 →</p> <p>46: 9.8 ↗</p> <p>47: 10.5x →</p> <p>48: 9.5 ←</p> <p>49: 9.2 ←</p> <p>50: 10.7x ↘</p> <p>Serie 98.7</p> <p>Total 488.1</p>	<p>60 Ligg</p>  <p>51: 8.9 ↑</p> <p>52: 9.1 ↗</p> <p>53: 8.6 ←</p> <p>54: 9.3 ↑</p> <p>55: 10.2 ↓</p> <p>56: 8.6 ↑</p> <p>57: 8.7 ↗</p> <p>58: 9.0 ←</p> <p>59: 9.4 ↑</p> <p>60: 10.0 →</p> <p>Serie 91.8</p> <p>Total 579.9</p>
---	--	--

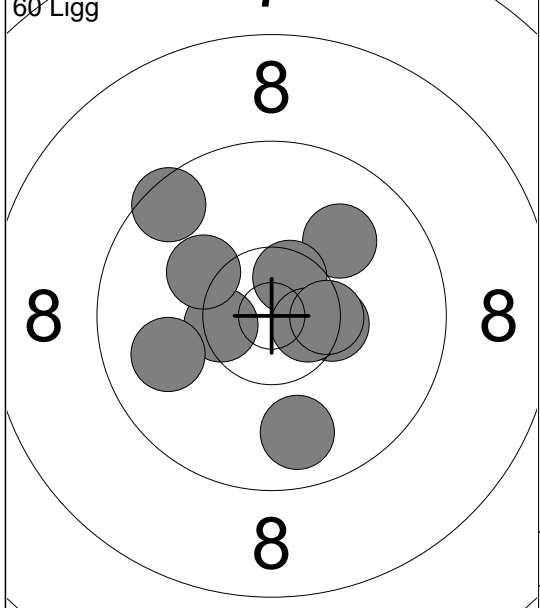

1:	9.5 ↖
2:	10.5 ↙
3:	10.0 ↗
4:	10.5 ↗
5:	10.4x →
6:	10.6x →
7:	9.9 ←
8:	10.2 ↖
9:	10.4x →
10:	9.8 ↓
Serie	101.8
Total	101.8

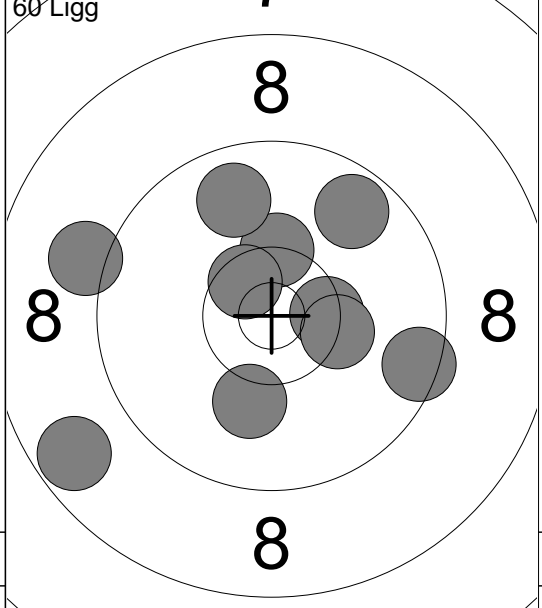

11:	10.3x ↗
12:	9.7 ↗
13:	10.4x →
14:	10.3x →
15:	8.7 ↙
16:	9.1 ←
17:	10.5x ↙
18:	10.1 ↓
19:	9.5 →
20:	9.8 ↖
Serie	98.4
Total	200.2

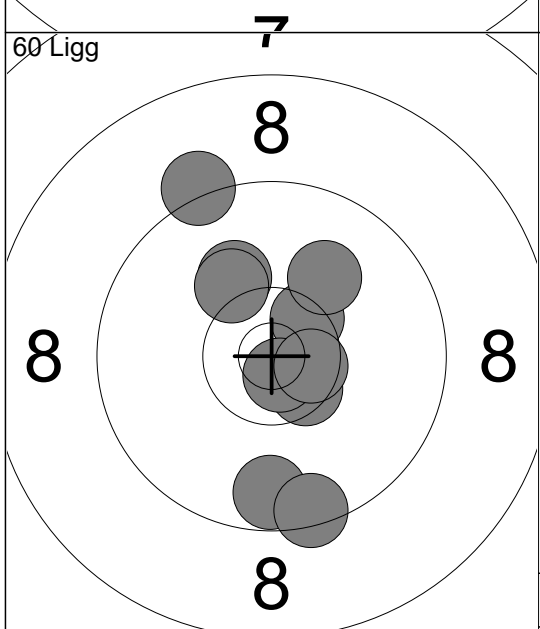

21:	9.7 ↓
22:	9.4 ↓
23:	10.5x ↗
24:	9.2 ↖
25:	10.5x ↙
26:	10.1 ↖
27:	10.8x ↙
28:	10.2 ↖
29:	10.6x →
30:	10.1 ↗
Serie	101.1
Total	301.3

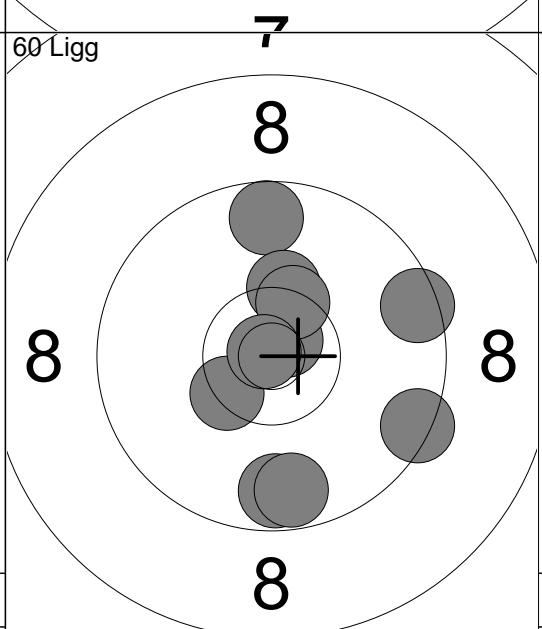

31:	9.6 ↑
32:	10.3x ↗
33:	10.4x ↙
34:	9.5 →
35:	10.7x ↗
36:	9.7 ↓
37:	9.7 ↓
38:	9.4 →
39:	10.4x ↗
40:	10.9x ↙
Serie	100.6
Total	401.9

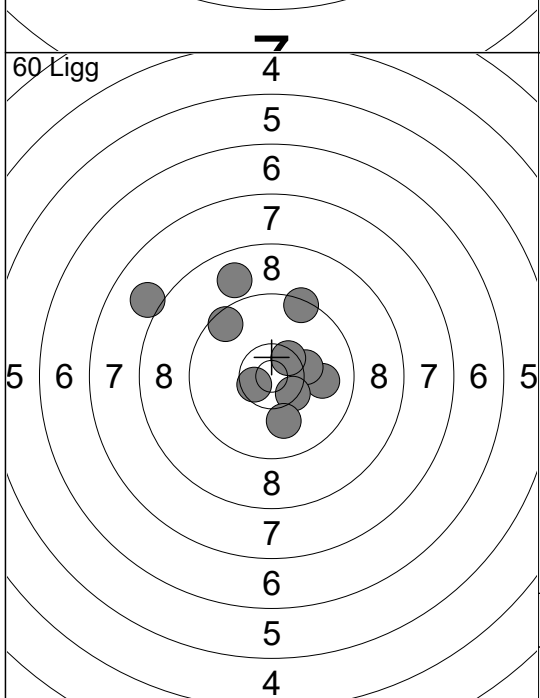

41:	9.9 →
42:	9.4 ↖
43:	10.6x ↙
44:	8.0 ↙
45:	10.2 →
46:	10.5x ↗
47:	8.9 ↖
48:	9.6 ↖
49:	10.4x ↙
50:	10.0 ↓
Serie	97.5
Total	499.4

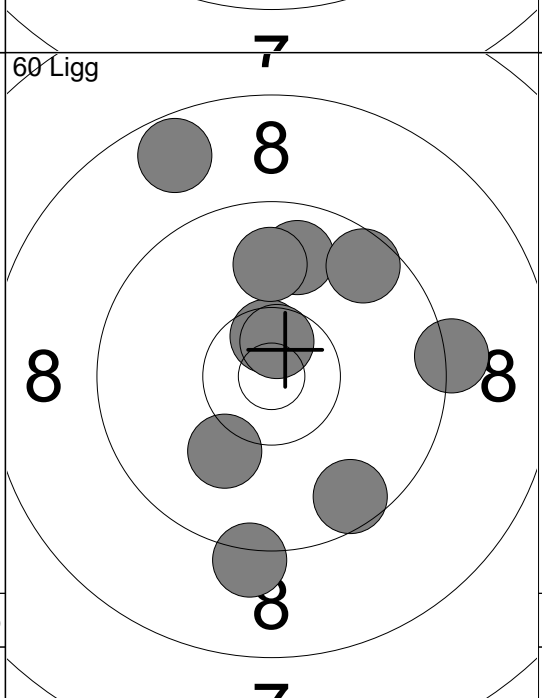

51:	9.2 ↓
52:	10.6x ↗
53:	9.8 ↖
54:	9.2 →
55:	10.6x ↗
56:	9.6 ↖
57:	8.7 ↖
58:	9.9 ↑
59:	10.1 ↙
60:	9.6 ↓
Serie	97.3
Total	596.7

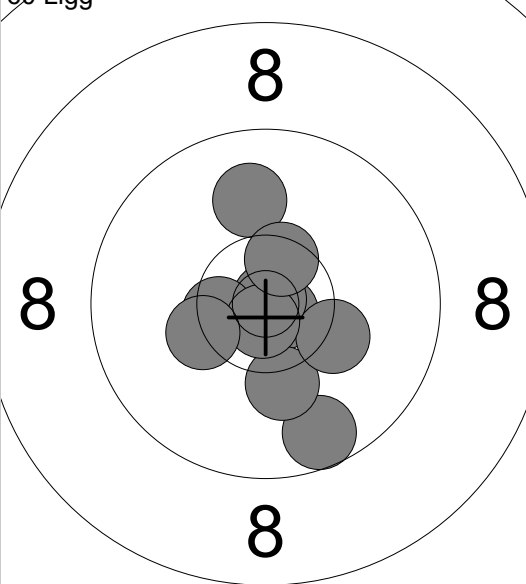
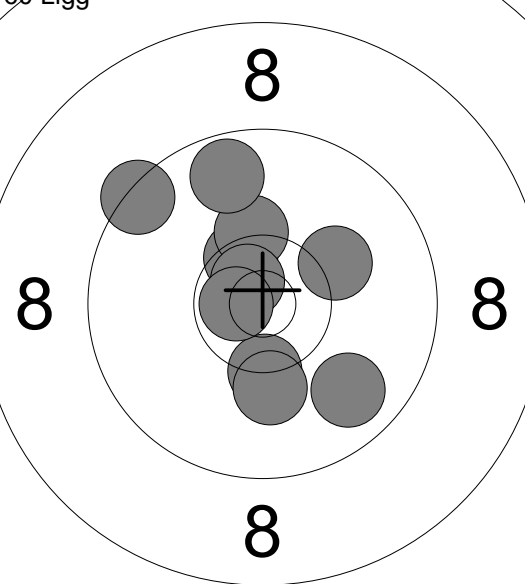

60 Ligg 	60 Ligg 	
1: 9.6 ↓ 2: 10.8x↘ 3: 10.2 ↓ 4: 10.9x↗ 5: 10.2 → 6: 10.5x↖ 7: 10.8x↓ 8: 10.3x↖ 9: 10.0 ↑ 10: 10.5x↗ Serie 103.8 Total 103.8	11: 10.2 ↗ 12: 10.5x↖ 13: 10.3 ↑ 14: 9.4 ↖ 15: 9.7 ↑ 16: 10.7x↖ 17: 10.3x↓ 18: 9.8 ↓ 19: 10.2 ↓ 20: 10.7x↖ Serie 101.8 Total 205.6	

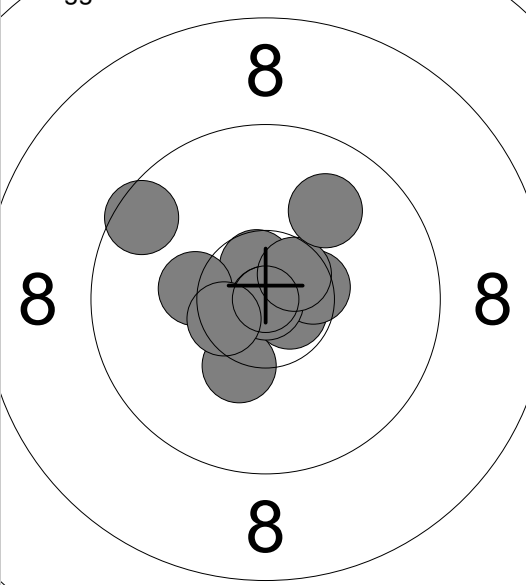
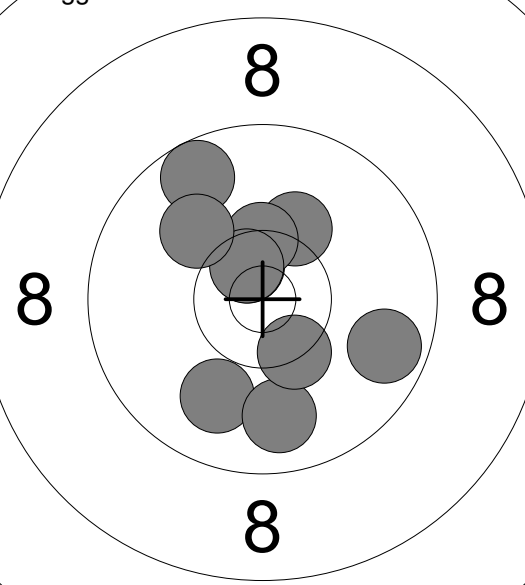
60 Ligg 	60 Ligg 	
21: 10.7x↘ 22: 10.6x↖ 23: 10.5x→ 24: 10.3 ↓ 25: 10.9x↓ 26: 9.6 ↖ 27: 10.6x↗ 28: 10.3↖ 29: 9.9 ↗ 30: 10.5x↖ Serie 103.9 Total 309.5	31: 9.9 ↓ 32: 9.8 ↓ 33: 9.7 → 34: 10.6x↖ 35: 10.2 ↑ 36: 10.4x↖ 37: 10.4x↓ 38: 10.6x↖ 39: 9.7 ↗ 40: 10.1 ↖ Serie 101.4 Total 410.9	

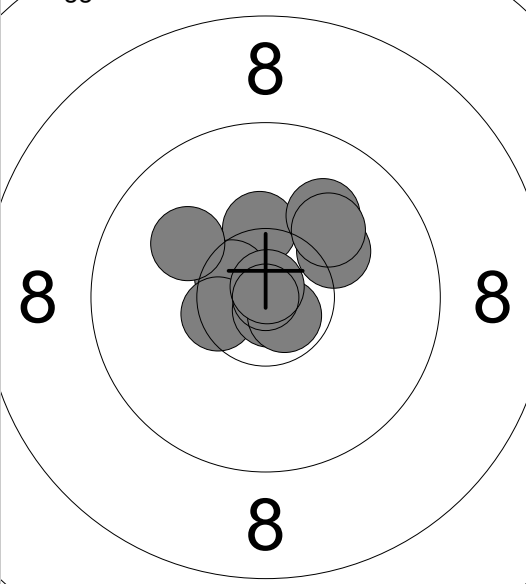
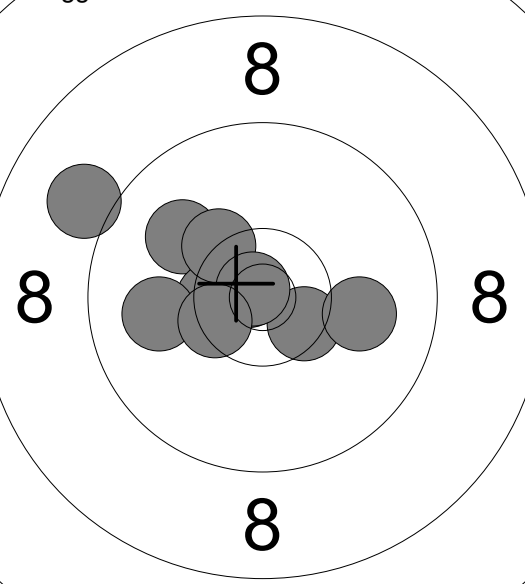
60 Ligg 	60 Ligg 	
41: 10.3x↖ 42: 10.6x↖ 43: 10.1 ↖ 44: 10.5x↖ 45: 10.2 ↗ 46: 10.8x↓ 47: 10.7x↘ 48: 10.0 ↗ 49: 10.9x↖ 50: 10.1 ↗ Serie 104.2 Total 515.1	51: 10.5x↘ 52: 10.0 ↖ 53: 10.0 → 54: 10.5x↖ 55: 10.8x↖ 56: 9.0 ↖ 57: 10.0↖ 58: 10.3x↖ 59: 10.8x↖ 60: 10.5x↖ Serie 102.4 Total 617.5	

<p>60 Ligg</p> <p style="text-align:center;"><b>8</b></p>	<p>1: 10.5x→</p> <p>2: 10.8x↘</p> <p>3: 10.1↖</p> <p>4: 9.8↗</p> <p>5: 9.4↙</p> <p>6: 10.1↘</p> <p>7: 10.0←</p> <p>8: 9.8←</p> <p>9: 10.2→</p> <p>10: 10.1←</p> <p>Serie 100.8</p> <p>Total 100.8</p>	<p>60 Ligg</p> <p style="text-align:center;"><b>8</b></p>	<p>11: 9.2←</p> <p>12: 10.1↖</p> <p>13: 9.7↖</p> <p>14: 10.5x↘</p> <p>15: 10.1↙</p> <p>16: 10.7x↓</p> <p>17: 10.3→</p> <p>18: 10.2↘</p> <p>19: 10.0↗</p> <p>20: 9.9↘</p> <p>Serie 100.7</p> <p>Total 201.5</p>
---	---	---	--

<p>60 Ligg</p> <p style="text-align:center;"><b>8</b></p>	<p>21: 10.0↗</p> <p>22: 9.8↖</p> <p>23: 9.9↙</p> <p>24: 10.5x↓</p> <p>25: 10.7x↖</p> <p>26: 9.6↘</p> <p>27: 9.8→</p> <p>28: 10.6x→</p> <p>29: 10.3x↓</p> <p>30: 9.8←</p> <p>Serie 101.0</p> <p>Total 302.5</p>	<p>60 Ligg</p> <p style="text-align:center;"><b>8</b></p>	<p>31: 10.2↖</p> <p>32: 9.4←</p> <p>33: 9.9↗</p> <p>34: 10.6x↘</p> <p>35: 9.1↖</p> <p>36: 10.7x↖</p> <p>37: 10.1↗</p> <p>38: 10.6x↓</p> <p>39: 8.9↗</p> <p>40: 10.0↗</p> <p>Serie 99.5</p> <p>Total 402.0</p>
---	--	---	---

<p>60 Ligg</p> <p style="text-align:center;"><b>8</b></p>	<p>41: 10.0↘</p> <p>42: 9.0↖</p> <p>43: 9.9←</p> <p>44: 10.4x→</p> <p>45: 9.3↖</p> <p>46: 10.0↗</p> <p>47: 9.7↗</p> <p>48: 10.3↗</p> <p>49: 9.5↖</p> <p>50: 10.2↗</p> <p>Serie 98.3</p> <p>Total 500.3</p>	<p>60 Ligg</p> <p style="text-align:center;"><b>8</b></p>	<p>51: 9.7↗</p> <p>52: 10.0↗</p> <p>53: 10.1↖</p> <p>54: 9.8↓</p> <p>55: 10.3x↘</p> <p>56: 10.0→</p> <p>57: 10.2↗</p> <p>58: 10.8x↖</p> <p>59: 10.4x↘</p> <p>60: 10.6x→</p> <p>Serie 101.9</p> <p>Total 602.2</p>
---	--	---	---

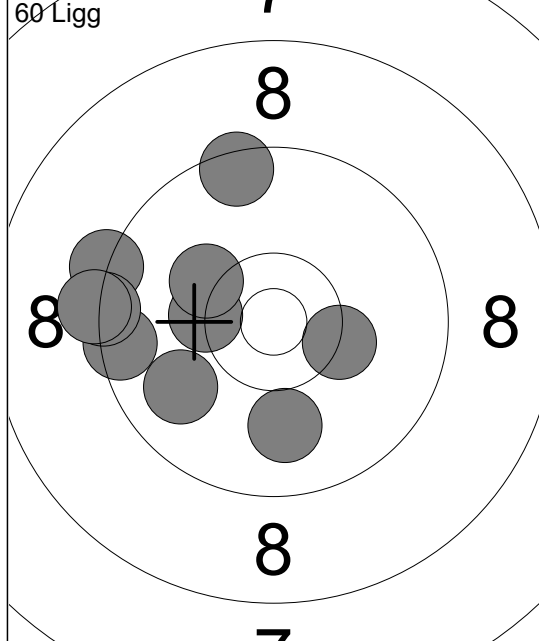

1:	9.9 ↙
2:	10.0 ↓
3:	9.5 ←
4:	10.3x ↘
5:	9.3 ←
6:	9.3 ←
7:	9.3 ←
8:	10.3x →
9:	9.5 ↑
10:	10.2 ↙
Serie 97.6	
Total 97.6	

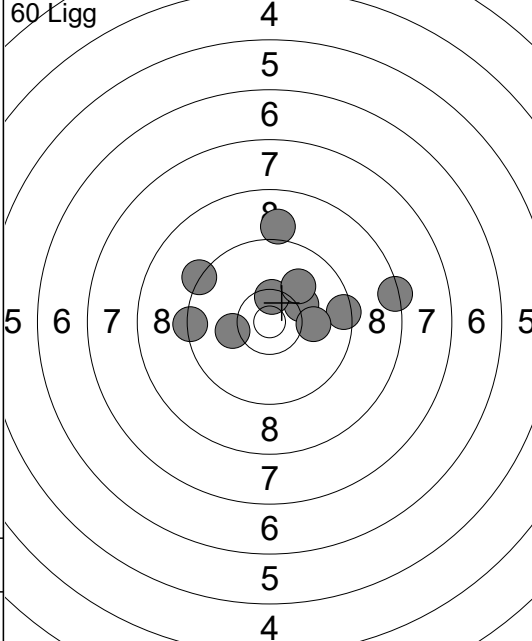

11:	10.2 ↗
12:	10.4x ↗
13:	10.2 ↙
14:	9.4 →
15:	10.1 →
16:	9.3 ↙
17:	9.4 ←
18:	8.4 →
19:	9.0 ↑
20:	10.0 ↗
Serie 96.4	
Total 194.0	

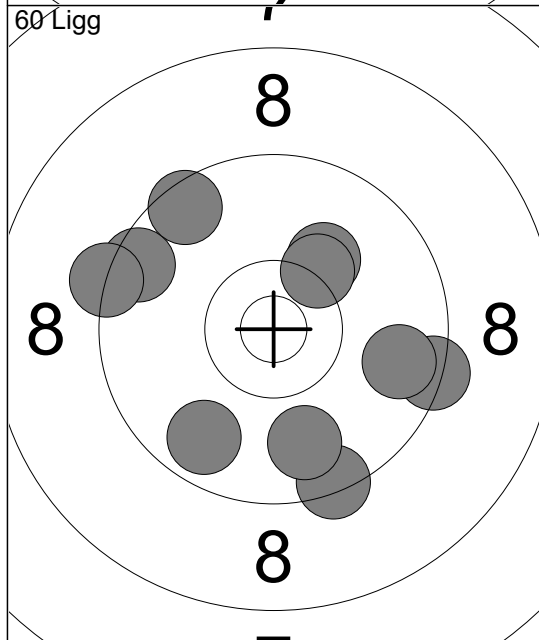

21:	10.1 ↗
22:	9.4 →
23:	9.4 ↓
24:	9.5 ↙
25:	9.8 ↓
26:	9.7 ↓
27:	10.3 ↗
28:	9.5 ↑
29:	9.3 ←
30:	9.7 →
Serie 96.7	
Total 290.7	

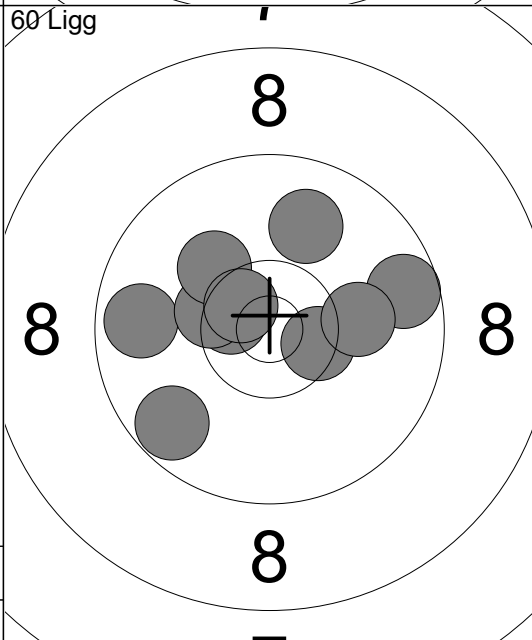

31:	9.7 ←
32:	9.7 ↙
33:	10.6x ↘
34:	10.5x →
35:	10.4x ↘
36:	10.2 ↙
37:	10.6x ↘
38:	9.6 →
39:	10.1 →
40:	9.9 ↑
Serie 101.3	
Total 392.0	

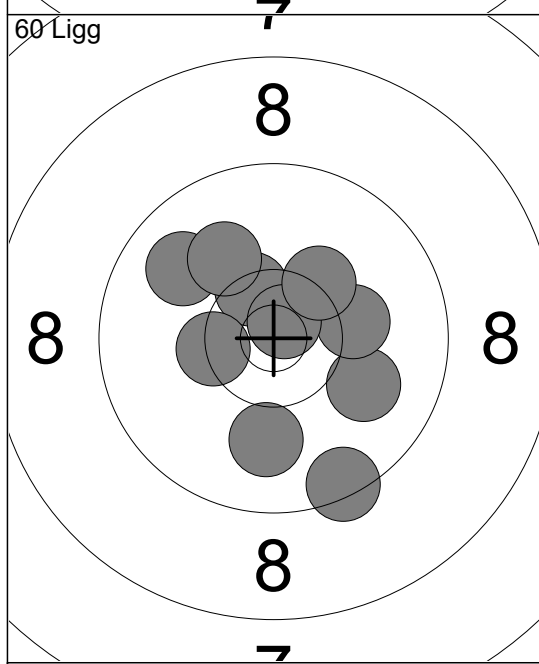

41:	9.9 ↙
42:	10.4x ↗
43:	10.0 →
44:	9.4 ↓
45:	10.2 →
46:	10.4x ↘
47:	10.8x ↗
48:	10.3 ↗
49:	10.0 ↓
50:	10.1 ↙
Serie 101.5	
Total 493.5	

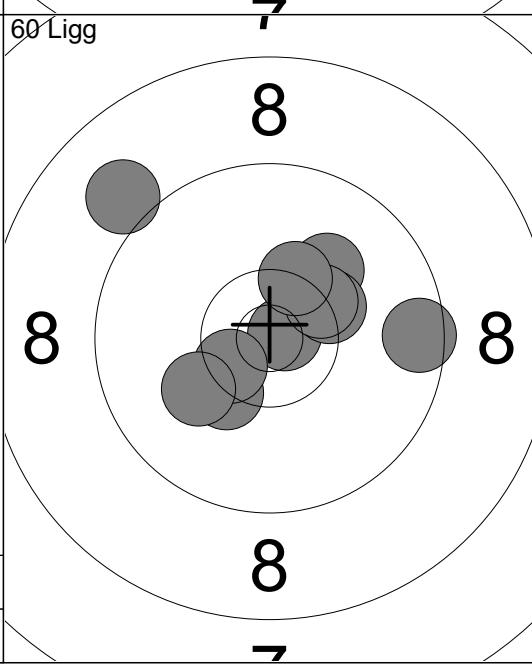

51:	9.0 ↙
52:	10.1 ↗
53:	10.8x →
54:	10.3x ↙
55:	10.5x ↙
56:	9.5 →
57:	10.3x ↗
58:	10.3x ↗
59:	10.3x ↗
60:	10.1 ↙
Serie 101.2	
Total 594.7	

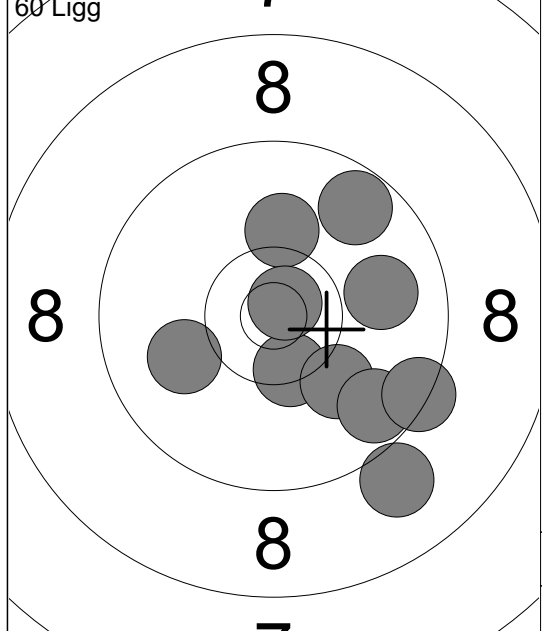

1: 10.4x	↘
2: 9.9	→
3: 10.1	↘
4: 10.1	↑
5: 9.7	↘
6: 9.7	↗
7: 10.8x	↗
8: 10.0	↙
9: 9.0	↘
10: 9.4	↘
Serie	99.1
Total	99.1

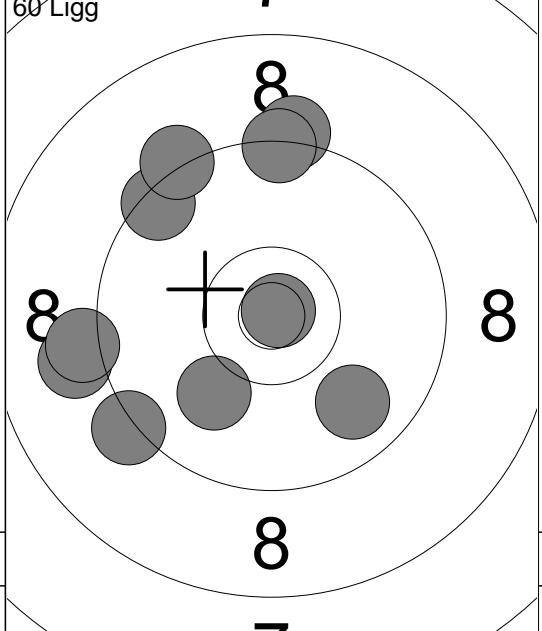

11: 9.2	↙
12: 10.0	↙
13: 9.8	↘
14: 9.1	←
15: 9.1	←
16: 9.4	↗
17: 9.2	↖
18: 9.2	↑
19: 9.3	↑
20: 10.9x	↗
Serie	95.2
Total	194.3

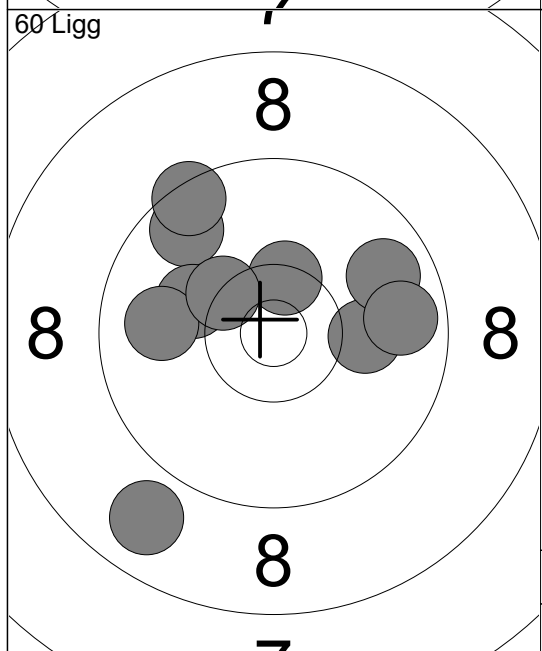

21: 9.7	↖
22: 8.8	↙
23: 10.1	↙
24: 9.9	←
25: 10.4x	↗
26: 10.1	→
27: 9.5	↖
28: 9.8	↗
29: 10.3x	↘
30: 9.7	→
Serie	98.3
Total	292.6

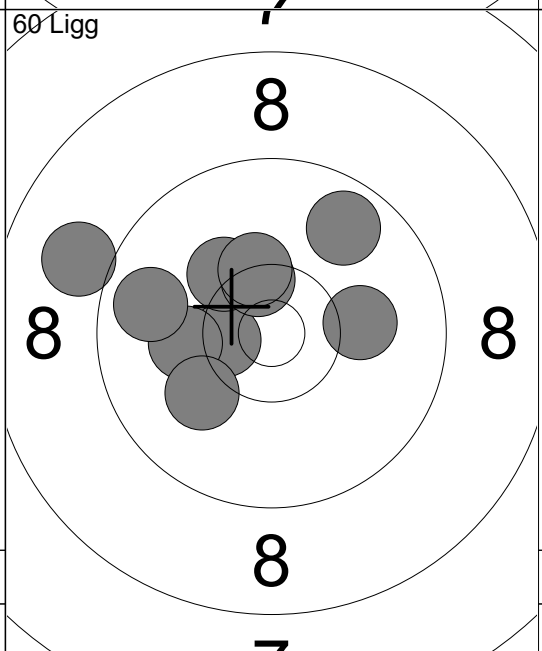

31: 10.5x	↙
32: 9.0	←
33: 10.1	←
34: 10.2	↖
35: 10.4x	↗
36: 10.3x	↗
37: 9.8	←
38: 10.1	↙
39: 10.1	→
40: 9.8	↗
Serie	100.3
Total	392.9

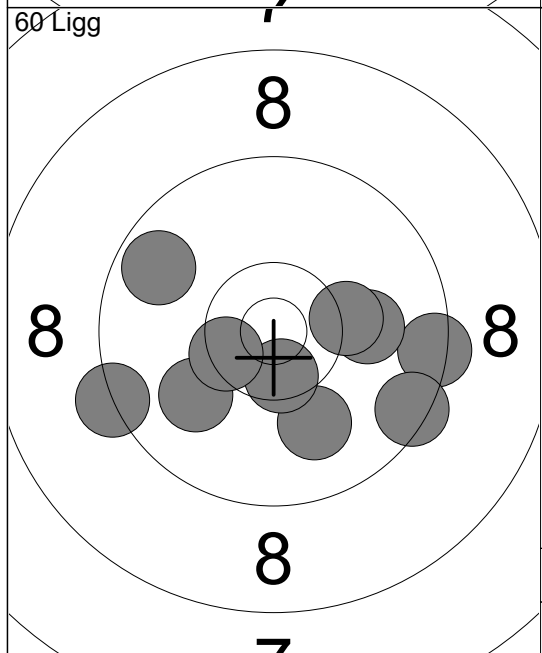

41: 9.4	→
42: 9.5	↘
43: 10.0	↙
44: 9.7	↖
45: 10.0	↘
46: 10.1	→
47: 10.3	→
48: 9.3	←
49: 10.5x	↘
50: 10.5x	↙
Serie	99.3
Total	492.2

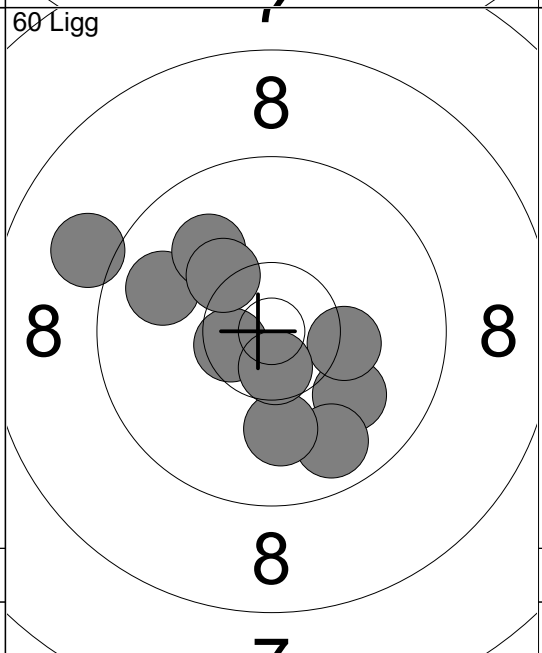

51: 10.0	↘
52: 10.5x	↙
53: 9.8	←
54: 9.8	↘
55: 10.0	↘
56: 9.1	←
57: 10.3	→
58: 10.0	↖
59: 10.6x	↘
60: 10.3	↖
Serie	100.4
Total	592.6

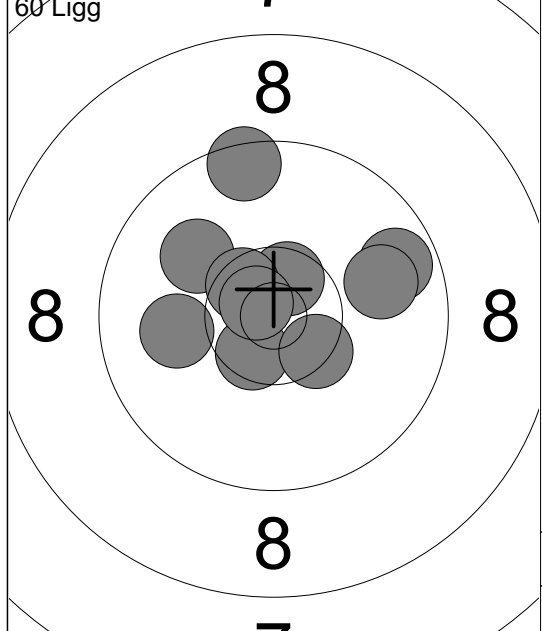

1:	10.0 ↖
2:	10.5x ↘
3:	10.6x ↗
4:	10.0 ←
5:	10.4x ↘
6:	10.5x ↘
7:	9.5 ↑
8:	9.7 →
9:	9.9 →
10:	10.7x ↘
Serie 101.8	
Total 101.8	

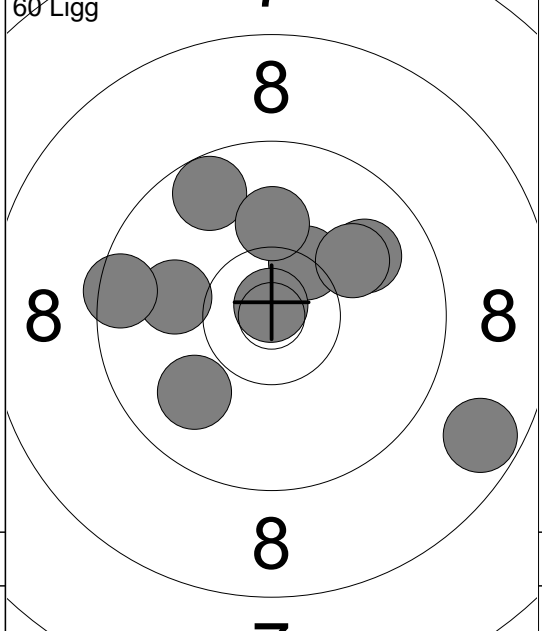

11:	9.9 ↗
12:	9.7 ↖
13:	10.4x ↗
14:	8.7 ↘
15:	10.0 ←
16:	9.9 ↘
17:	9.5 ←
18:	10.0 ↗
19:	10.8x ↗
20:	10.1 ↑
Serie 99.0	
Total 200.8	

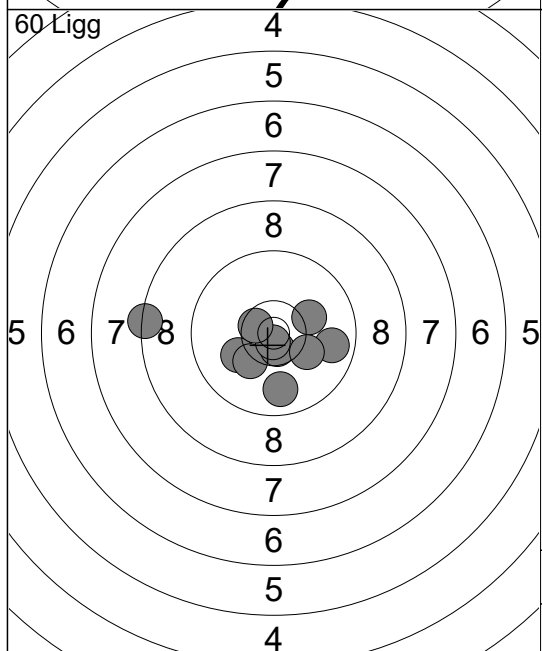

21:	9.8 ↓
22:	10.2 →
23:	10.1 ↖
24:	10.2 ↘
25:	10.6x ↘
26:	10.8x ↘
27:	10.5x ↘
28:	9.8 →
29:	10.2 →
30:	8.4 ←
Serie 100.6	
Total 301.4	

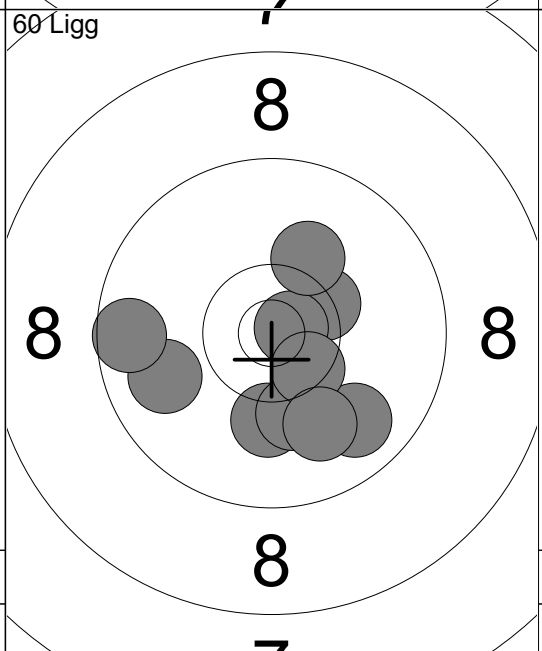

31:	10.4x ↗
32:	10.1 ↓
33:	10.2 ↓
34:	10.8x →
35:	9.9 ←
36:	9.6 ←
37:	10.2 ↑
38:	9.8 ↘
39:	10.5x ↘
40:	10.0 ↓
Serie 101.5	
Total 402.9	

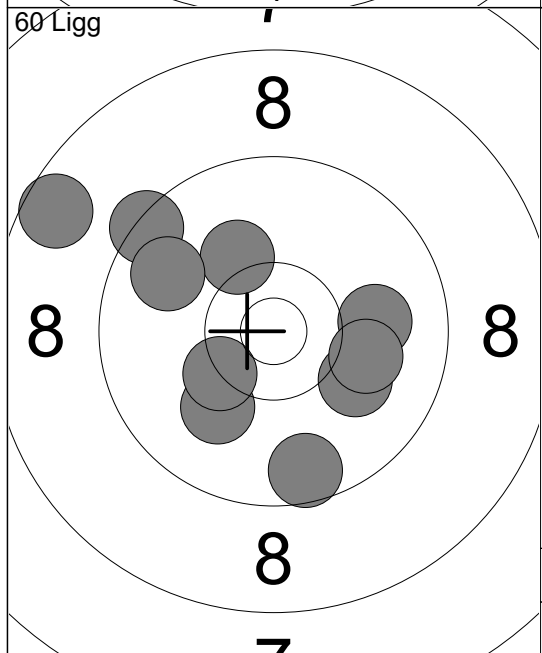

41:	10.0 →
42:	10.1 →
43:	10.1 ↘
44:	10.1 →
45:	10.2 ↗
46:	9.4 ↖
47:	9.6 ↓
48:	10.3x ↘
49:	8.6 ←
50:	9.8 ↖
Serie 98.2	
Total 501.1	

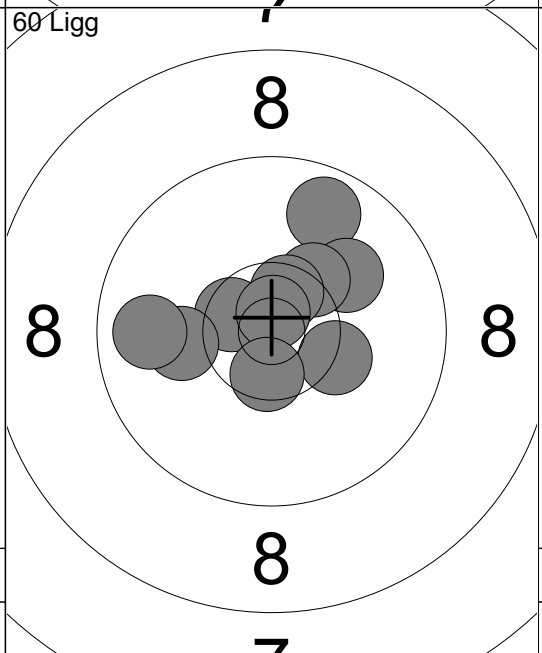

51:	9.7 ↗
52:	10.1 ↗
53:	10.5x ↘
54:	10.1 ←
55:	10.3x ↘
56:	10.3x ↗
57:	10.6x ↗
58:	9.8 ←
59:	10.8x ↗
60:	10.5x ↘
Serie 102.7	
Total 603.8	

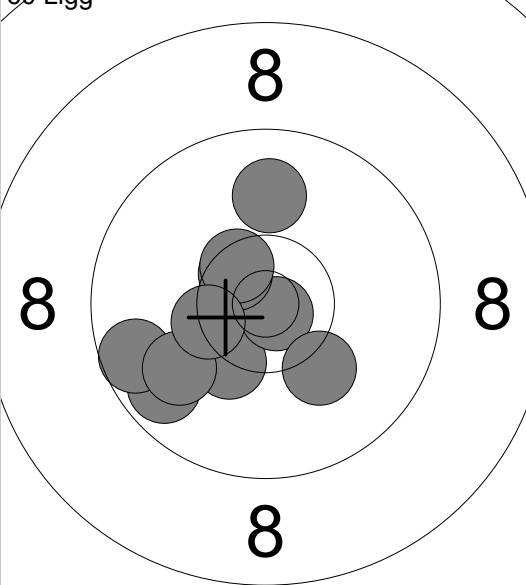
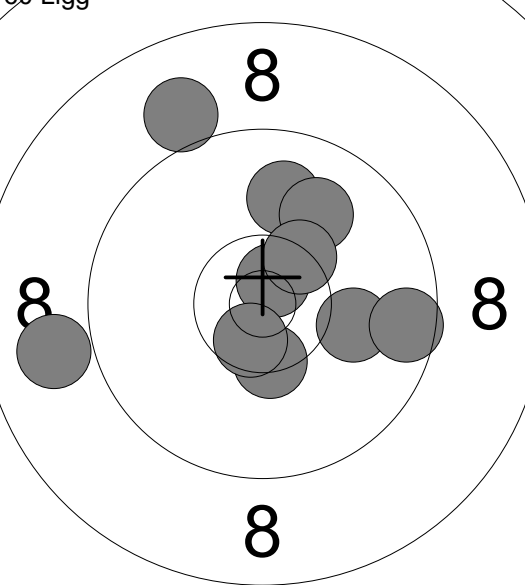
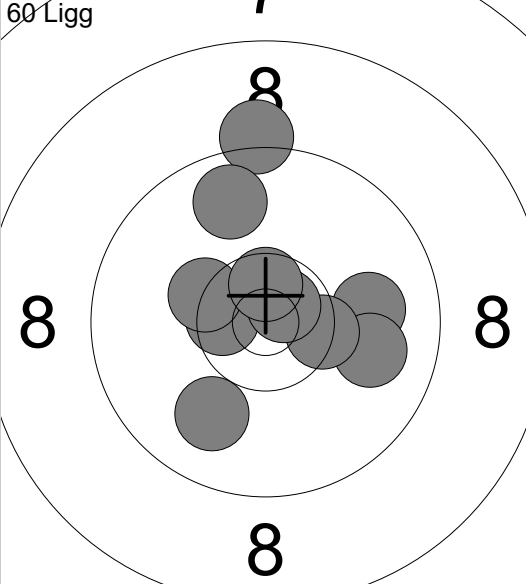
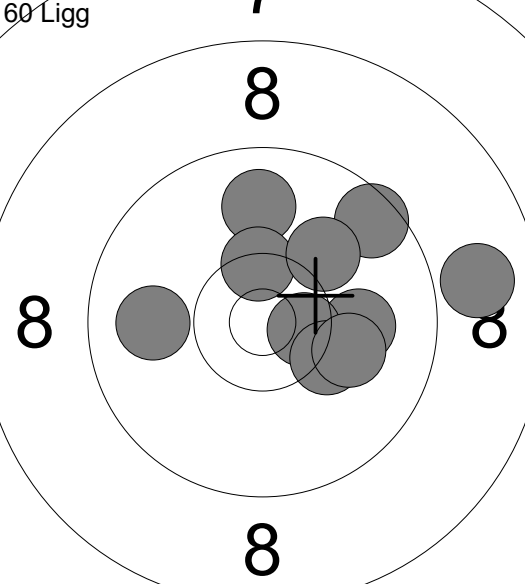
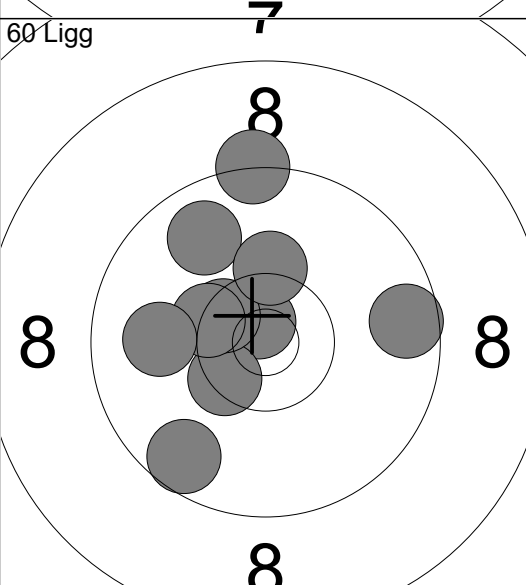
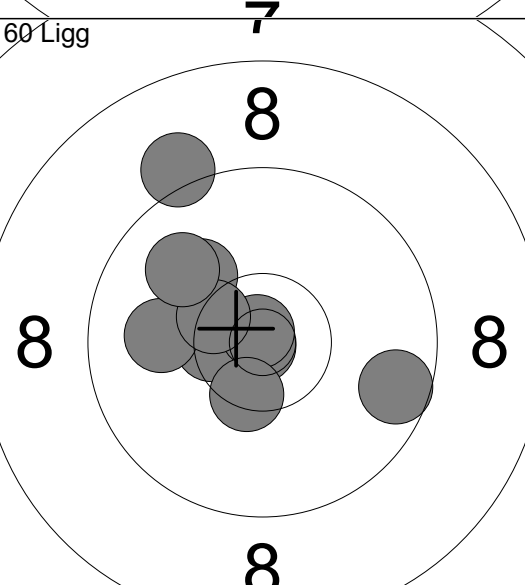
<p>60 Ligg</p> 	<p>1: 10.3x ↘                  2: 10.8x ↘                  3: 9.7 ↙                  4: 10.2 ↘                  5: 9.6 ←                  6: 9.9 ↙                  7: 10.5x ↘                  8: 9.9 ↑                  9: 10.5x ↘                  10: 10.4x ↘</p> <p>Serie 101.8                  Total 101.8</p>	<p>60 Ligg</p> 	<p>11: 10.4x ↘                  12: 9.9 ↑                  13: 10.0 ↗                  14: 10.7x ↗                  15: 10.6x ↘                  16: 9.0 ↖                  17: 10.1 →                  18: 9.6 →                  19: 8.9 ←                  20: 10.4x ↗</p> <p>Serie 99.6                  Total 201.4</p>
<p>60 Ligg</p> 	<p>21: 10.5x ↘                  22: 10.0 →                  23: 10.3x ↘                  24: 9.2 ↑                  25: 9.8 ↑                  26: 9.9 →                  27: 10.4x →                  28: 9.9 ↘                  29: 10.7x ↗                  30: 10.6x ↑</p> <p>Serie 101.3                  Total 302.7</p>	<p>60 Ligg</p> 	<p>31: 10.0 →                  32: 10.6x →                  33: 10.3 ↘                  34: 9.9 ↑                  35: 9.5 ↗                  36: 10.1 →                  37: 10.4x ↑                  38: 8.9 →                  39: 9.9 ←                  40: 10.1 ↗</p> <p>Serie 99.7                  Total 402.4</p>
<p>60 Ligg</p> 	<p>41: 10.7x ↘                  42: 10.4x ↘                  43: 10.5x ↘                  44: 9.8 ↖                  45: 9.6 ↘                  46: 9.3 ↑                  47: 9.6 →                  48: 10.4x ↘                  49: 10.0 ←                  50: 10.2 ↑</p> <p>Serie 100.5                  Total 502.9</p>	<p>60 Ligg</p> 	<p>51: 10.9x ↘                  52: 10.5x ↘                  53: 10.0 ←                  54: 10.1 ↖                  55: 10.8x ↘                  56: 10.4x ↘                  57: 9.1 ↖                  58: 10.4x ↘                  59: 9.9 ↖                  60: 9.6 →</p> <p>Serie 101.7                  Total 604.6</p>

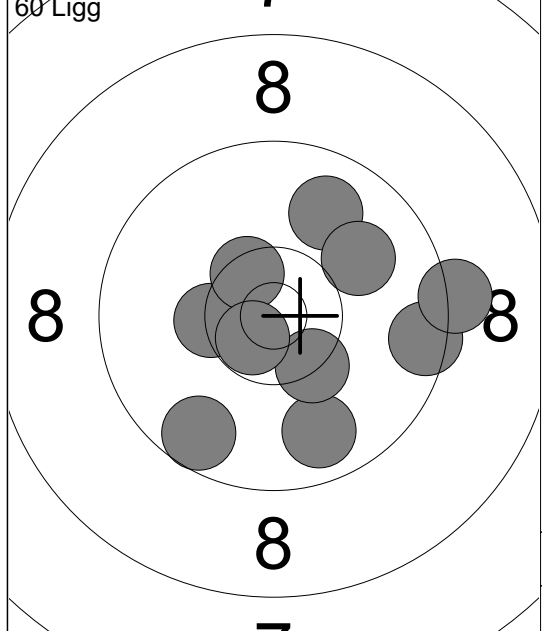

1:	9.9	↗
2:	9.6	↙
3:	10.0	↗
4:	9.8	↙
5:	10.4	✕
6:	9.5	→
7:	10.5	↖
8:	9.2	→
9:	10.4	↘
10:	10.7	↘
Serie		100.0
Total		100.0

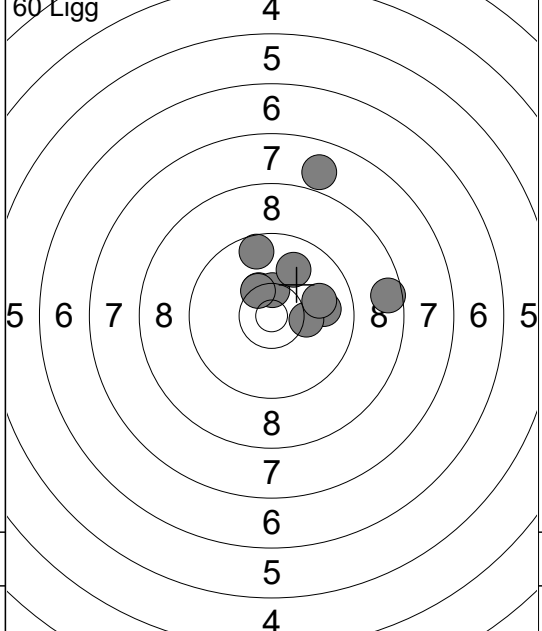

11:	9.9	→
12:	10.4	↖
13:	8.6	→
14:	9.6	↑
15:	10.4	↑
16:	7.9	↑
17:	10.2	→
18:	9.9	↑
19:	10.4	↖
20:	10.0	→
Serie		97.3
Total		197.3

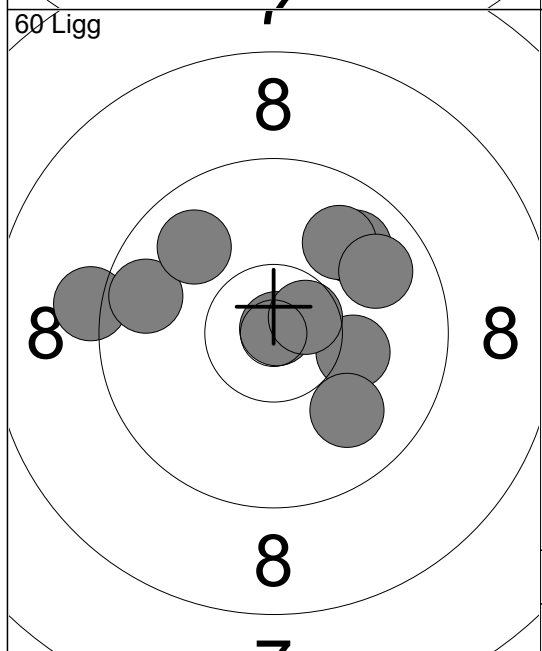

21:	10.9	↗
22:	10.2	→
23:	9.8	↗
24:	10.6	↗
25:	9.2	←
26:	9.9	↗
27:	9.8	↗
28:	9.7	←
29:	9.8	↗
30:	9.9	↘
Serie		99.8
Total		297.1

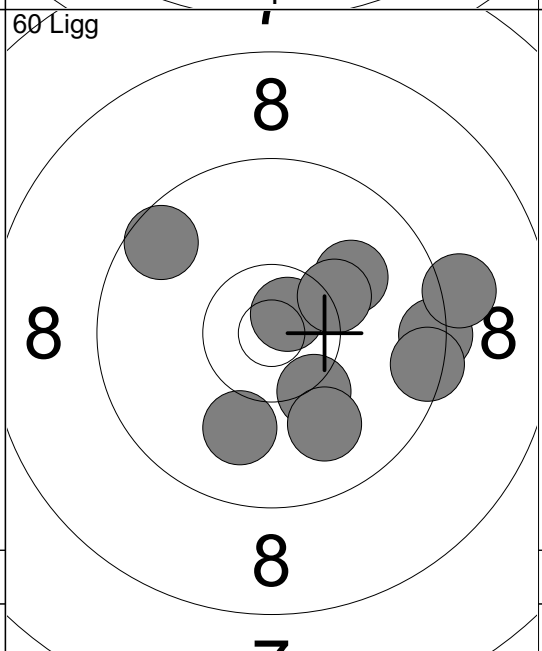

31:	10.0	↗
32:	9.6	↖
33:	9.4	→
34:	9.1	→
35:	9.5	→
36:	10.3	↘
37:	10.0	↘
38:	10.0	↘
39:	10.7	↗
40:	10.3	↗
Serie		98.9
Total		396.0

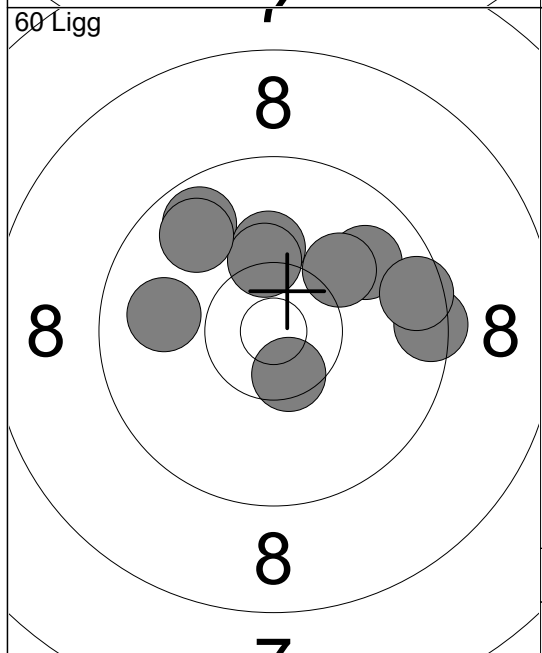

41:	9.7	↖
42:	9.9	↗
43:	9.9	←
44:	9.5	→
45:	9.6	→
46:	10.2	↑
47:	10.5	↘
48:	10.3	↑
49:	10.1	↗
50:	9.8	↖
Serie		99.5
Total		495.5

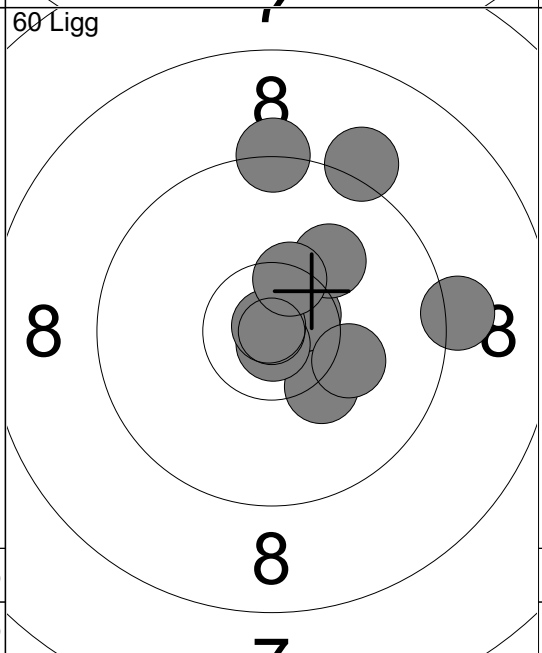

51:	10.6	↗
52:	10.2	↘
53:	10.2	→
54:	10.8	↘
55:	9.2	↑
56:	9.2	→
57:	10.9	↖
58:	10.1	↗
59:	10.4	↑
60:	9.3	↑
Serie		100.9
Total		596.4

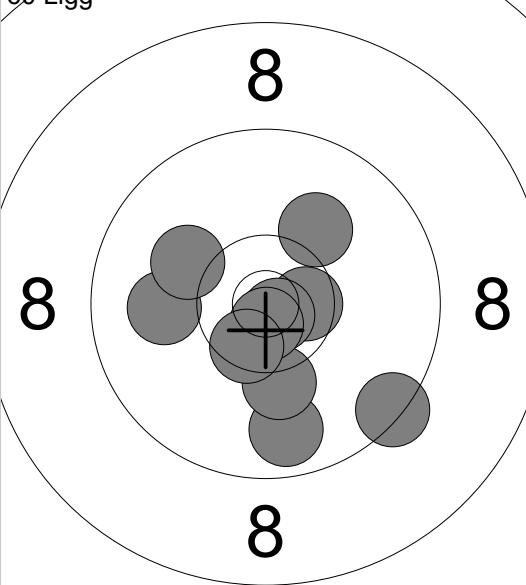
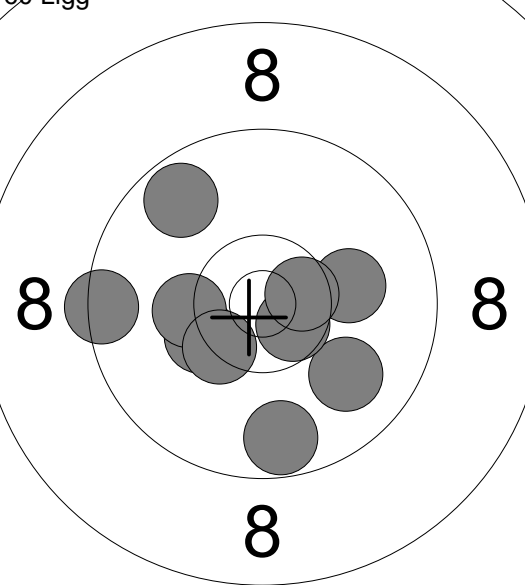
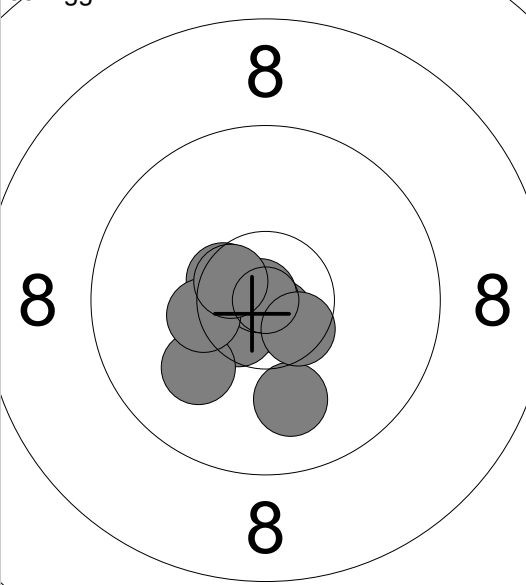
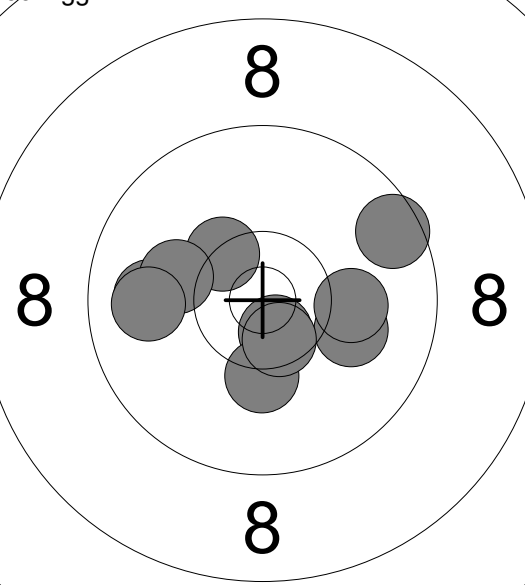
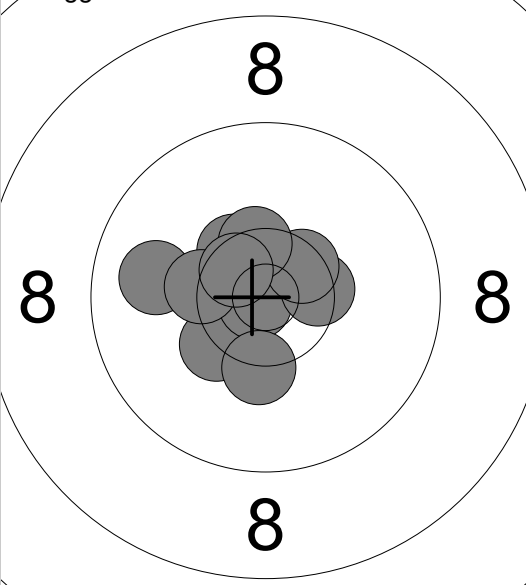
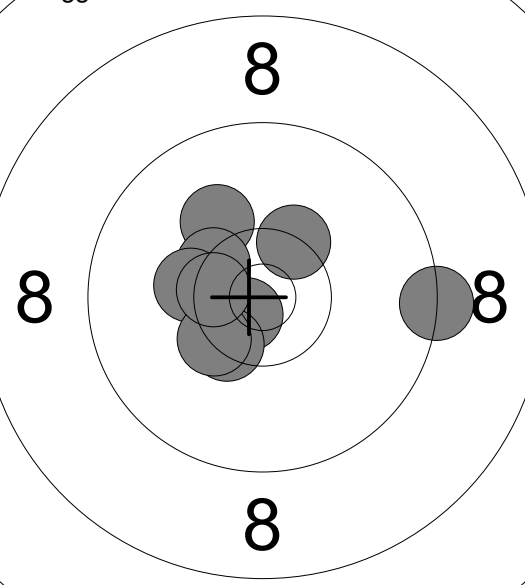
<p>60 Ligg</p>  <p style="text-align: center; font-size: 2em;"><b>8</b></p>	<p>1: 9.8 ↓</p> <p>2: 10.6x→</p> <p>3: 10.2 ↓</p> <p>4: 10.8x↘</p> <p>5: 9.4 ↘</p> <p>6: 10.0 ←</p> <p>7: 10.8x↓</p> <p>8: 10.5x↘</p> <p>9: 10.1 ↗</p> <p>10: 10.1 ↖</p>	<p>60 Ligg</p>  <p style="text-align: center; font-size: 2em;"><b>8</b></p>	<p>11: 9.7 ↗</p> <p>12: 10.1 →</p> <p>13: 9.9 ↘</p> <p>14: 10.3x↘</p> <p>15: 9.7 ↓</p> <p>16: 10.3 ←</p> <p>17: 9.4 ←</p> <p>18: 10.6x↘</p> <p>19: 10.6x→</p> <p>20: 10.4x↘</p>
<b>7</b>	Serie 102.3	<b>7</b>	Serie 101.0
<b>7</b>	Total 102.3	<b>7</b>	Total 203.3
<p>60 Ligg</p>  <p style="text-align: center; font-size: 2em;"><b>8</b></p>	<p>21: 10.0 ↓</p> <p>22: 10.8x↘</p> <p>23: 10.5x↘</p> <p>24: 10.5x↘</p> <p>25: 10.6x↘</p> <p>26: 10.9x↘</p> <p>27: 10.1 ↓</p> <p>28: 10.3x↘</p> <p>29: 10.5x↘</p> <p>30: 10.6x↘</p>	<p>60 Ligg</p>  <p style="text-align: center; font-size: 2em;"><b>8</b></p>	<p>31: 10.6x↓</p> <p>32: 10.4x↘</p> <p>33: 10.2 ↓</p> <p>34: 10.1 →</p> <p>35: 9.9 ←</p> <p>36: 9.6 ↗</p> <p>37: 10.5x↓</p> <p>38: 10.1 ←</p> <p>39: 10.1 →</p> <p>40: 9.9 ←</p>
<b>7</b>	Serie 104.8	<b>7</b>	Serie 101.4
<b>7</b>	Total 308.1	<b>7</b>	Total 409.5
<p>60 Ligg</p>  <p style="text-align: center; font-size: 2em;"><b>8</b></p>	<p>41: 10.3x↘</p> <p>42: 10.8x↘</p> <p>43: 10.3 ↓</p> <p>44: 10.5x→</p> <p>45: 10.4x↘</p> <p>46: 9.9 ←</p> <p>47: 10.5x↗</p> <p>48: 10.4x↗</p> <p>49: 10.3x↘</p> <p>50: 10.6x↘</p>	<p>60 Ligg</p>  <p style="text-align: center; font-size: 2em;"><b>8</b></p>	<p>51: 10.5x↘</p> <p>52: 10.1 ↖</p> <p>53: 10.4x↘</p> <p>54: 10.7x↘</p> <p>55: 10.4x↘</p> <p>56: 10.3 ←</p> <p>57: 10.4x↗</p> <p>58: 10.3x↘</p> <p>59: 10.5x↘</p> <p>60: 9.3 →</p>
<b>7</b>	Serie 104.0	<b>7</b>	Serie 102.9
<b>7</b>	Total 513.5	<b>7</b>	Total 616.4



<p>60 Ligg</p>	<p>1: 10.2 ↙ 2: 10.0 ↓ 3: 9.5 ← 4: 10.3 ↗ 5: 10.6x↓ 6: 10.4x↘ 7: 10.3 → 8: 10.1 ↑ 9: 10.2 ↑ 10: 10.6x↓</p> <p>Serie 102.2 Total 102.2</p>	<p>60 Ligg</p>	<p>11: 10.1 ↗ 12: 10.5x↗ 13: 10.2 ↓ 14: 10.4x↘ 15: 10.7x↘ 16: 10.6x↓ 17: 9.9 ← 18: 10.2 ↓ 19: 9.7 ↑ 20: 10.1 ↑</p> <p>Serie 102.4 Total 204.6</p>
----------------	---	----------------	---

<p>60 Ligg</p>	<p>21: 10.2 ↘ 22: 10.0 → 23: 10.4x↘ 24: 10.3x↓ 25: 9.7 ← 26: 10.2 ↙ 27: 10.5x↘ 28: 10.7x↑ 29: 10.0 ↑ 30: 10.8x↘</p> <p>Serie 102.8 Total 307.4</p>	<p>60 Ligg</p>	<p>31: 10.4x↙ 32: 10.0 → 33: 10.3 ↓ 34: 10.0 → 35: 9.4 → 36: 10.0 ↙ 37: 10.6x↘ 38: 10.5x↙ 39: 10.1 ↑ 40: 9.5 →</p> <p>Serie 100.8 Total 408.2</p>
----------------	--	----------------	---

<p>60 Ligg</p>	<p>41: 10.1 → 42: 10.1 ↙ 43: 10.8x↑ 44: 10.3x↙ 45: 10.4x↓ 46: 10.6x↗ 47: 10.2 ↙ 48: 10.3x↘ 49: 10.0 ↓ 50: 10.4x↗</p> <p>Serie 103.2 Total 511.4</p>	<p>60 Ligg</p>	<p>51: 10.4x↙ 52: 10.2 ↘ 53: 10.0 ↗ 54: 10.1 ↑ 55: 10.2 ↙ 56: 9.7 ↘ 57: 10.1 → 58: 10.1 ← 59: 10.2 ↓ 60: 10.4x→</p> <p>Serie 101.4 Total 612.8</p>
----------------	---	----------------	--

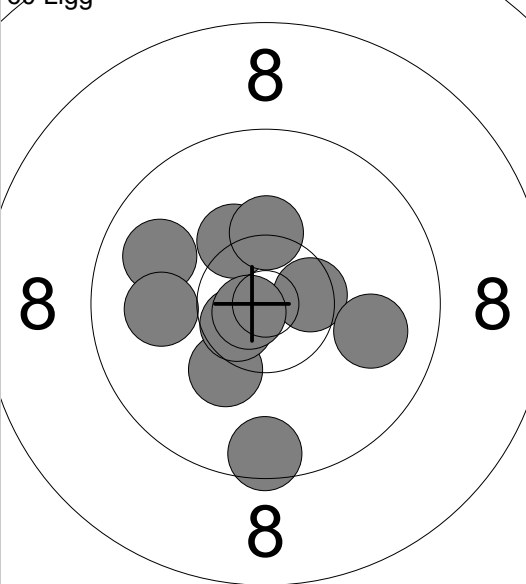
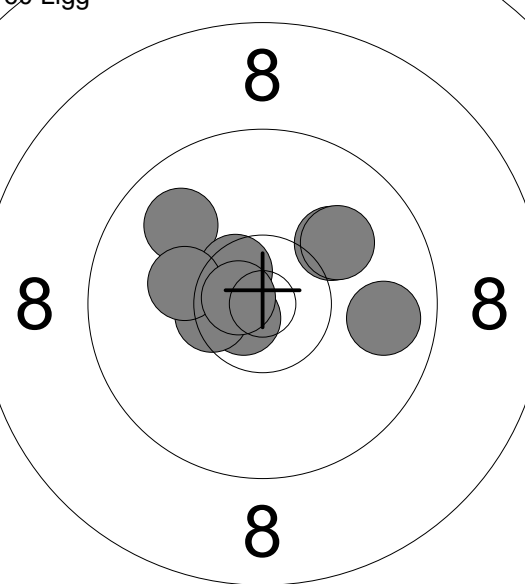
<p>60 Ligg</p>  <p style="text-align: center; font-size: 2em;"><b>8</b></p>	<p>1: 9.5 ↓</p> <p>2: 9.9 ↖</p> <p>3: 10.5x➤</p> <p>4: 10.2 ↓</p> <p>5: 10.3 ↗</p> <p>6: 10.6x↙</p> <p>7: 9.9 ➡</p> <p>8: 10.0 ←</p> <p>9: 10.3 ↑</p> <p>10: 10.8x↘</p>	<p>60 Ligg</p>  <p style="text-align: center; font-size: 2em;"><b>8</b></p>	<p>11: 9.9 ↖</p> <p>12: 10.7x↙</p> <p>13: 10.7x↘</p> <p>14: 10.5x↙</p> <p>15: 10.5x↗</p> <p>16: 10.1 ↗</p> <p>17: 10.2 ↖</p> <p>18: 10.0 ↗</p> <p>19: 9.8 ➡</p> <p>20: 10.7x↙</p>
Serie 102.0		Serie 103.1	
Total 102.0		Total 205.1	

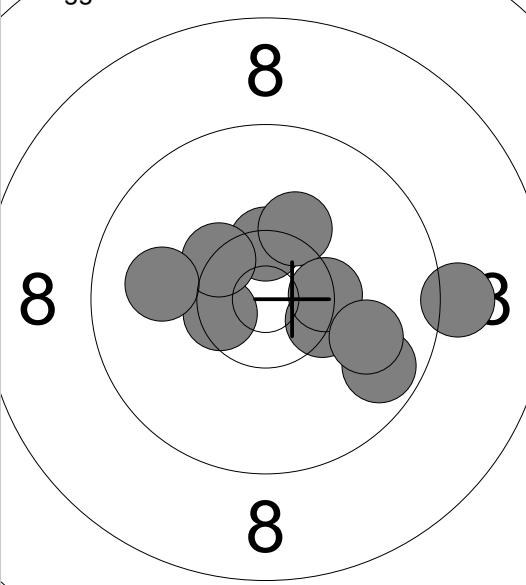
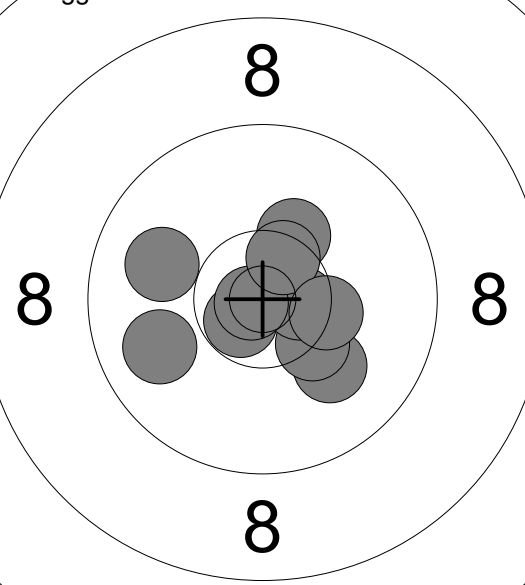
<p>60 Ligg</p>  <p style="text-align: center; font-size: 2em;"><b>8</b></p>	<p>21: 9.1 ➡</p> <p>22: 10.4x↑</p> <p>23: 9.7 ➤</p> <p>24: 10.5x↙</p> <p>25: 10.2 ↑</p> <p>26: 10.4x➤</p> <p>27: 10.4x↘</p> <p>28: 10.4x➤</p> <p>29: 10.0 ←</p> <p>30: 9.9 ➤</p>	<p>60 Ligg</p>  <p style="text-align: center; font-size: 2em;"><b>8</b></p>	<p>31: 10.1 ↓</p> <p>32: 10.3x↘</p> <p>33: 9.9 ↖</p> <p>34: 10.7x↘</p> <p>35: 10.3 ↑</p> <p>36: 10.6x➤</p> <p>37: 10.8x↙</p> <p>38: 9.9 ↖</p> <p>39: 10.5x↑</p> <p>40: 10.3x➤</p>
Serie 101.0		Serie 103.4	
Total 306.1		Total 409.5	

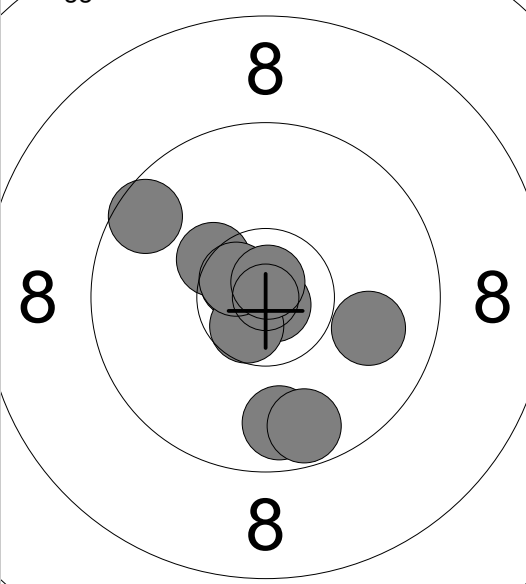
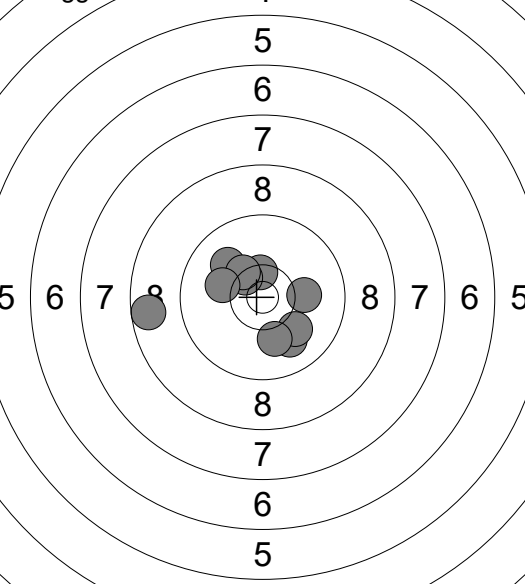
<p>60 Ligg</p>  <p style="text-align: center; font-size: 2em;"><b>8</b></p>	<p>41: 10.6x↘</p> <p>42: 9.6 ↖</p> <p>43: 9.9 ➤</p> <p>44: 9.8 ↓</p> <p>45: 10.3x↘</p> <p>46: 10.8x↘</p> <p>47: 10.6x↘</p> <p>48: 9.7 ↓</p> <p>49: 10.6x↘</p> <p>50: 10.8x↑</p>	<p>60 Ligg</p>  <p style="text-align: center; font-size: 2em;"><b>4</b></p>	<p>51: 10.4x↑</p> <p>52: 10.0 ↖</p> <p>53: 10.4x↘</p> <p>54: 10.1 ➡</p> <p>55: 10.3x↘</p> <p>56: 9.9 ↓</p> <p>57: 10.0 ↓</p> <p>58: 10.1 ↓</p> <p>59: 8.6 ←</p> <p>60: 10.1 ↖</p>
Serie 102.7		Serie 99.9	
Total 512.2		Total 612.1	

<p>60 Ligg</p>	<p>1: 9.9 →                  2: 10.3 ↑                  3: 9.5 ←                  4: 10.6x↘                  5: 10.5x↑                  6: 9.6 ↖                  7: 10.3x↘                  8: 10.0 ←                  9: 10.6x↘                  10: 10.5x↘</p> <p>Serie 101.8 Total 101.8</p>	<p>60 Ligg</p>	<p>11: 10.2 ↘                  12: 9.9 ←                  13: 10.0 ↖                  14: 10.4x→                  15: 10.3x↘                  16: 10.5x↘                  17: 10.3 ←                  18: 10.5x↖                  19: 10.0 ↘                  20: 10.4x↘</p> <p>Serie 102.5 Total 204.3</p>
----------------	--	----------------	---

<p>60 Ligg</p>	<p>21: 9.8 →                  22: 10.5x→                  23: 10.6x→                  24: 9.5 →                  25: 10.0 ←                  26: 10.5x→                  27: 10.1 ↘                  28: 10.0 ←                  29: 10.3 ↑                  30: 10.5x↘</p> <p>Serie 101.8 Total 306.1</p>	<p>60 Ligg</p>	<p>31: 10.3x↘                  32: 10.4x↖                  33: 9.7 ↓                  34: 10.4x↑                  35: 10.2 ←                  36: 8.6 ←                  37: 10.1 ←                  38: 10.6x↘                  39: 10.3 ↘                  40: 10.3x↘</p> <p>Serie 100.9 Total 407.0</p>
----------------	--	----------------	--

<p>60 Ligg</p>	<p>41: 10.4x↘                  42: 9.8 ↖                  43: 10.1 ←                  44: 10.0 ↗                  45: 10.6x↘                  46: 10.3x→                  47: 10.4x↘                  48: 10.6x↗                  49: 9.7 ↑                  50: 9.8 →</p> <p>Serie 101.7 Total 508.7</p>	<p>60 Ligg</p>	<p>51: 10.4x↘                  52: 10.6x→                  53: 9.4 →                  54: 9.9 ↑                  55: 10.4x↘                  56: 10.3x↘                  57: 10.8x↗                  58: 10.8x↗                  59: 10.7x↘                  60: 10.7x↘</p> <p>Serie 104.0 Total 612.7</p>
----------------	---	----------------	--

<p>60 Ligg</p>	<p>60 Ligg</p>	<p>60 Ligg</p>	<p>60 Ligg</p>
<p>60 Ligg</p>	<p>60 Ligg</p>		

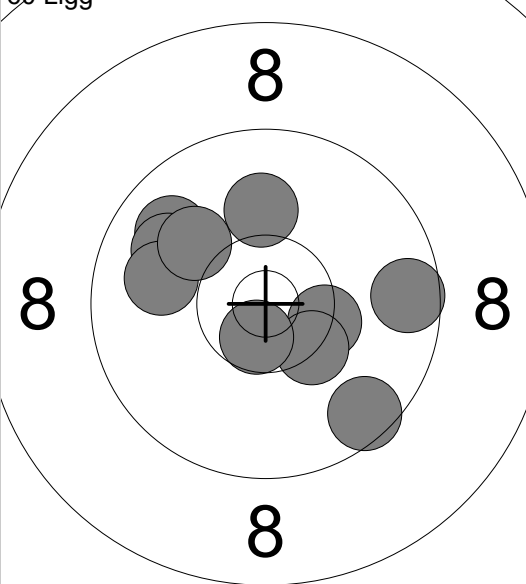
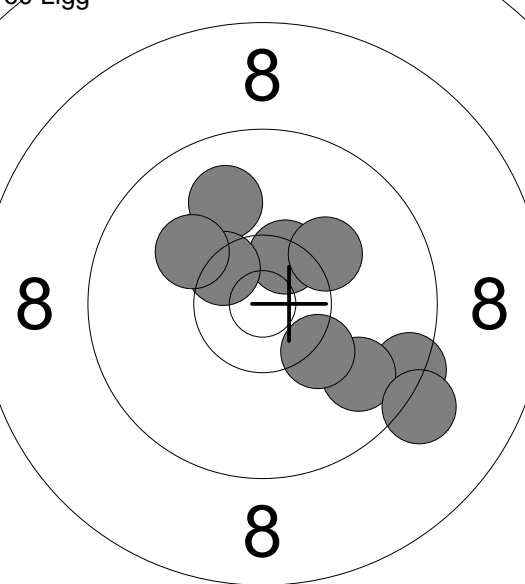
<p>60 Ligg</p>  <p style="text-align: center;">8</p>	<p>1: 10.4x➔</p> <p>2: 9.6 ↘</p> <p>3: 10.3x➔</p> <p>4: 10.6x↘</p> <p>5: 10.1 ↑</p> <p>6: 9.8 ↖</p> <p>7: 9.6 →</p> <p>8: 9.9 ↖</p> <p>9: 9.9 ←</p> <p>10: 10.1 ↖</p>	<p>60 Ligg</p>  <p style="text-align: center;">8</p>	<p>11: 9.4 ➔</p> <p>12: 10.2 ↖</p> <p>13: 9.9 ↗</p> <p>14: 10.5x↗</p> <p>15: 10.2 ↗</p> <p>16: 10.4x↖</p> <p>17: 9.8 ↘</p> <p>18: 9.2 ↘</p> <p>19: 10.1 ↖</p> <p>20: 10.3 ↘</p>
Serie 100.3		Serie 100.0	
Total 100.3		Total 200.3	

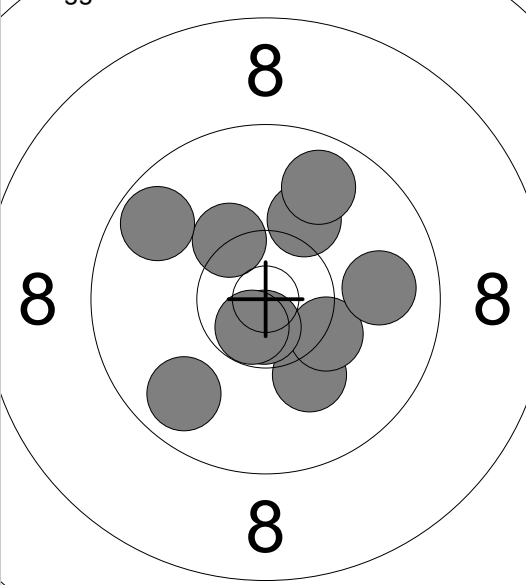
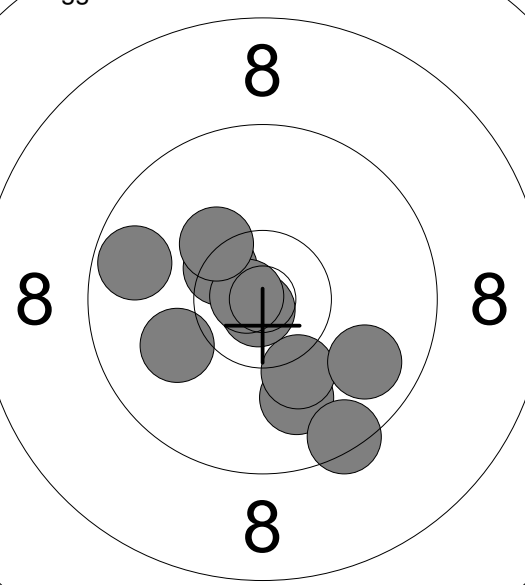
<p>60 Ligg</p>  <p style="text-align: center;">8</p>	<p>21: 10.1 ↘</p> <p>22: 10.3x➔</p> <p>23: 10.7x↘</p> <p>24: 10.3x↖</p> <p>25: 9.7 ↖</p> <p>26: 10.1 ↑</p> <p>27: 9.8 ↗</p> <p>28: 10.7x↘</p> <p>29: 9.8 ↘</p> <p>30: 9.9 →</p>	<p>60 Ligg</p>  <p style="text-align: center;">8</p>	<p>31: 10.0 ↘</p> <p>32: 10.2 ↘</p> <p>33: 10.8x↘</p> <p>34: 9.7 ←</p> <p>35: 9.8 ↘</p> <p>36: 10.5x↖</p> <p>37: 9.4 ↘</p> <p>38: 10.0 ↙</p> <p>39: 10.8x↖</p> <p>40: 10.3 ↖</p>
Serie 101.4		Serie 101.5	
Total 301.7		Total 403.2	

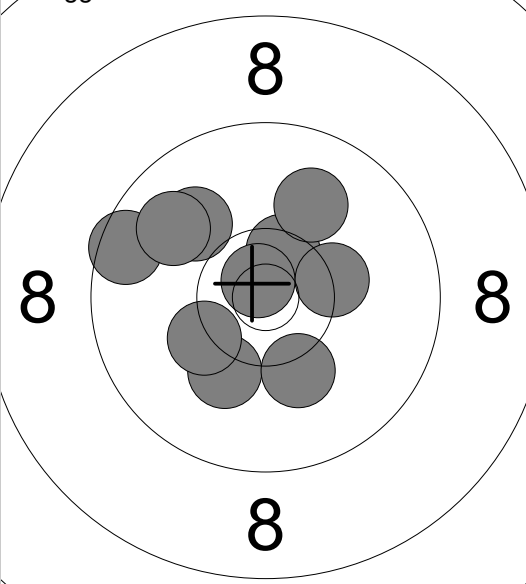
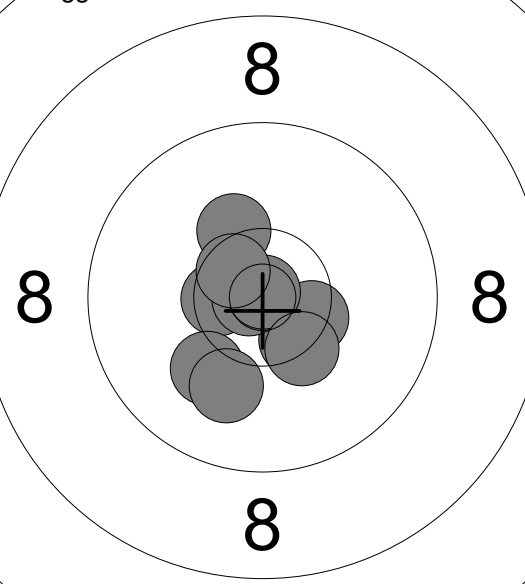
<p>60 Ligg</p>  <p style="text-align: center;">8</p>	<p>41: 9.5 ←</p> <p>42: 10.5x↗</p> <p>43: 10.0 ↗</p> <p>44: 10.8x↖</p> <p>45: 10.0 ↖</p> <p>46: 10.2 ↘</p> <p>47: 10.3 ↙</p> <p>48: 10.3x➔</p> <p>49: 9.9 ↖</p> <p>50: 10.2 ↘</p>	<p>60 Ligg</p>  <p style="text-align: center;">8</p>	<p>51: 10.5x↖</p> <p>52: 10.4x↘</p> <p>53: 10.8x↖</p> <p>54: 10.4x➔</p> <p>55: 10.3 ↗</p> <p>56: 10.9x↗</p> <p>57: 10.6x↖</p> <p>58: 10.1 ↘</p> <p>59: 10.0 ↘</p> <p>60: 10.3x↘</p>
Serie 101.7		Serie 104.3	
Total 504.9		Total 609.2	

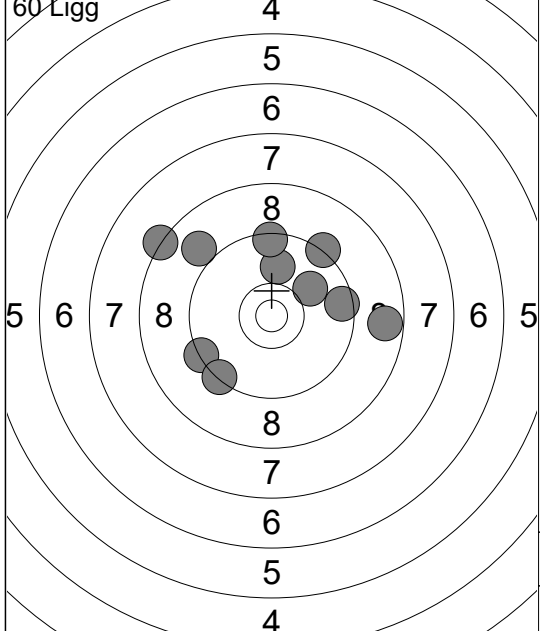

1:	8.3	↖
2:	9.3	↙
3:	9.3	↘
4:	9.0	↖
5:	9.3	↗
6:	9.5	→
7:	10.0	↗
8:	8.7	→
9:	10.0	↑
10:	9.4	↑
Serie		92.8
Total		92.8

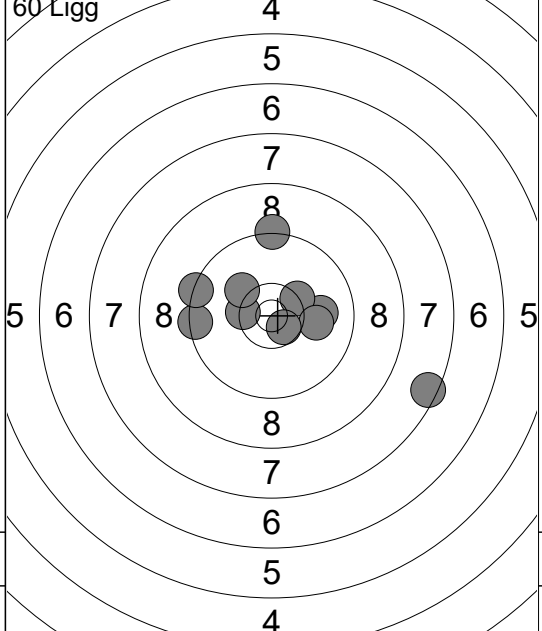

11:	7.5	↘
12:	10.4	↖
13:	9.3	↑
14:	10.0	→
15:	10.3	↗
16:	10.0	→
17:	9.4	←
18:	9.4	←
19:	10.2	↖
20:	10.6	↘
Serie		97.1
Total		189.9

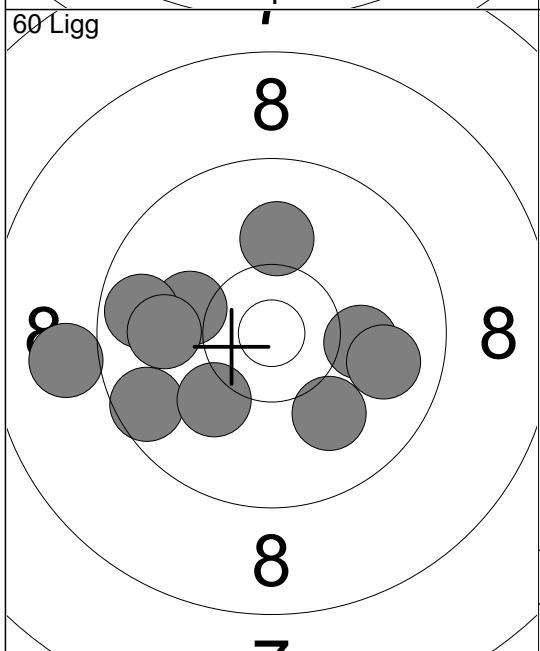

21:	10.0	↘
22:	10.1	←
23:	9.6	↙
24:	10.1	↑
25:	9.0	←
26:	9.7	←
27:	10.1	→
28:	10.1	↘
29:	9.9	←
30:	9.9	→
Serie		98.5
Total		288.4

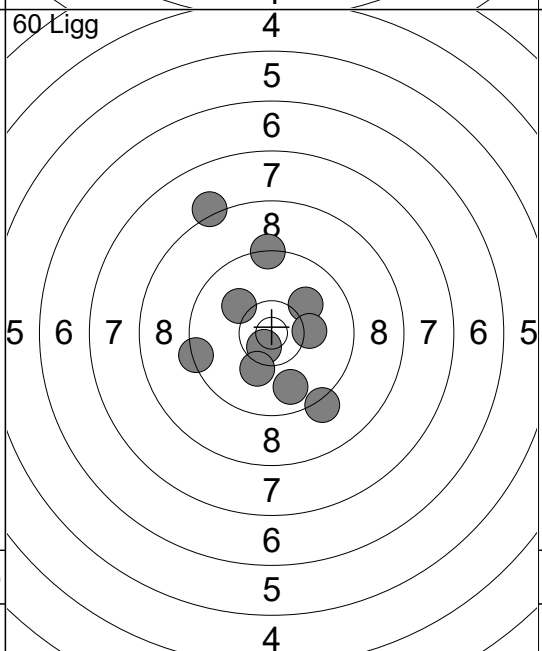

31:	10.6	↘
32:	9.3	↑
33:	10.2	↘
34:	10.1	↖
35:	10.1	↗
36:	10.2	→
37:	9.4	←
38:	8.2	↗
39:	9.8	↘
40:	9.2	↘
Serie		97.1
Total		385.5

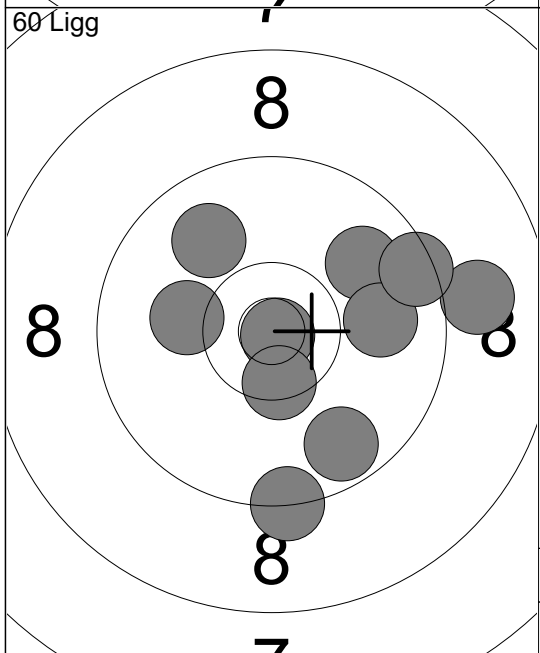

41:	9.0	→
42:	9.9	↗
43:	10.9	↘
44:	9.9	→
45:	9.9	↖
46:	9.3	↘
47:	10.5	↘
48:	10.1	←
49:	9.7	↘
50:	9.5	→
Serie		98.7
Total		484.2

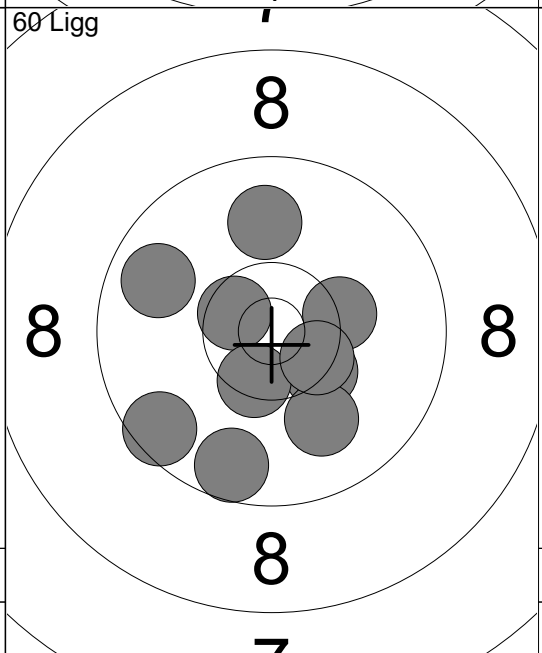

51:	10.3	↗
52:	10.6	↖
53:	9.5	↙
54:	9.6	↘
55:	10.4	↘
56:	10.5	↘
57:	9.9	↑
58:	10.0	↘
59:	9.8	←
60:	10.5	↘
Serie		101.1
Total		585.3

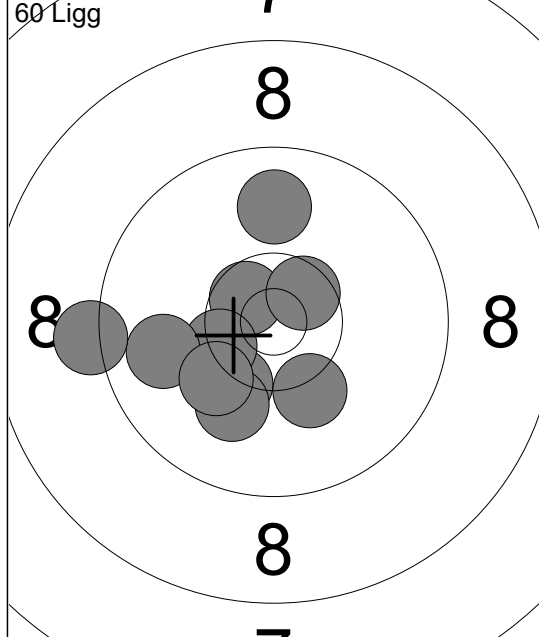

1:	9.9	↑
2:	10.3	↙
3:	10.2	↘
4:	10.6	↘
5:	10.4	↘
6:	9.9	←
7:	9.2	←
8:	10.6	↗
9:	10.1	↘
10:	10.2	↘
Serie		101.4
Total		101.4

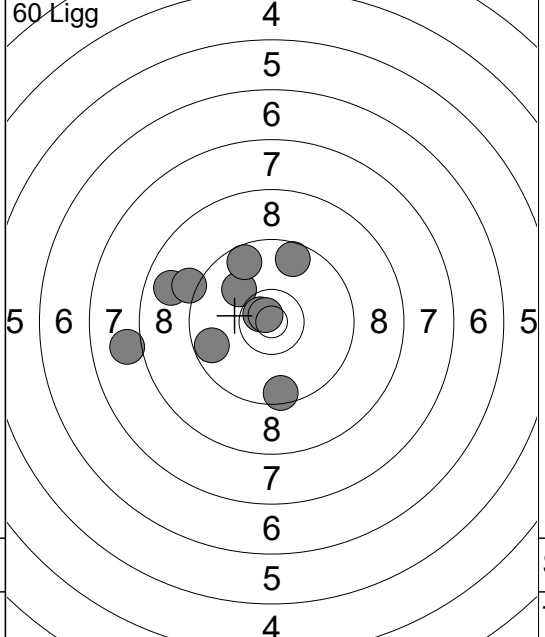

11:	10.0	↖
12:	8.8	←
13:	9.5	↘
14:	10.7	↘
15:	9.6	↑
16:	9.7	←
17:	9.2	←
18:	10.8	↘
19:	9.6	↑
20:	8.0	←
Serie		95.9
Total		197.3

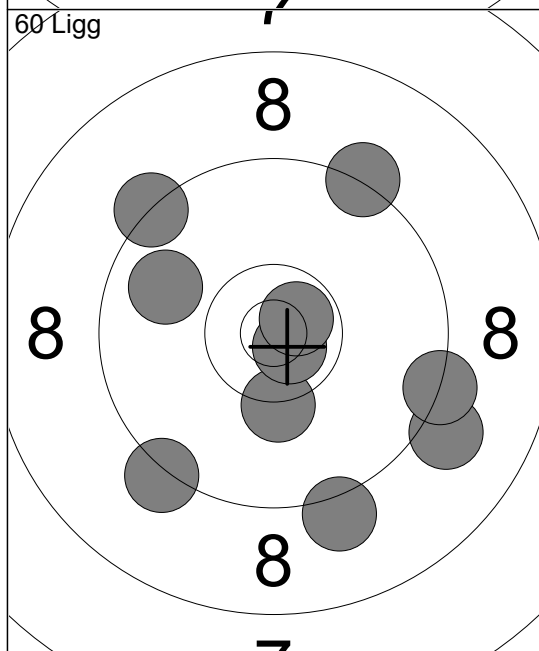

21:	9.1	↘
22:	9.2	↘
23:	9.1	→
24:	10.3	↘
25:	10.8	↘
26:	9.3	↑
27:	9.8	←
28:	9.3	→
29:	9.3	↖
30:	10.7	↗
Serie		96.9
Total		294.2

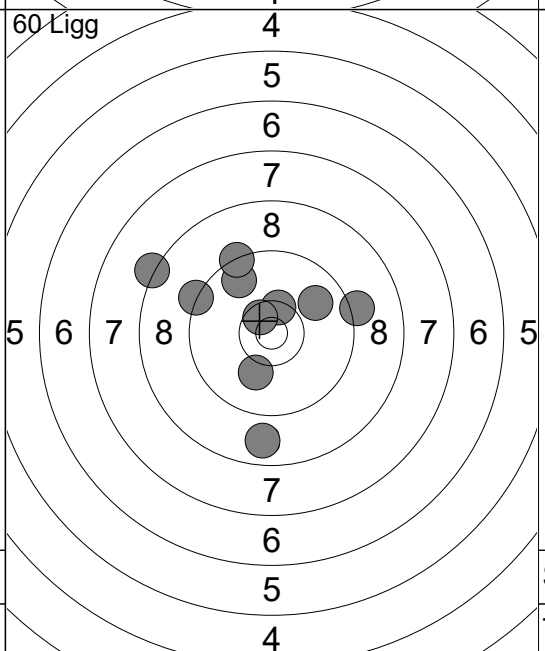

31:	10.4	↗
32:	8.2	←
33:	9.7	↖
34:	9.3	←
35:	9.3	↖
36:	8.8	↘
37:	9.2	→
38:	9.9	↗
39:	10.1	↘
40:	10.6	↘
Serie		95.5
Total		389.7

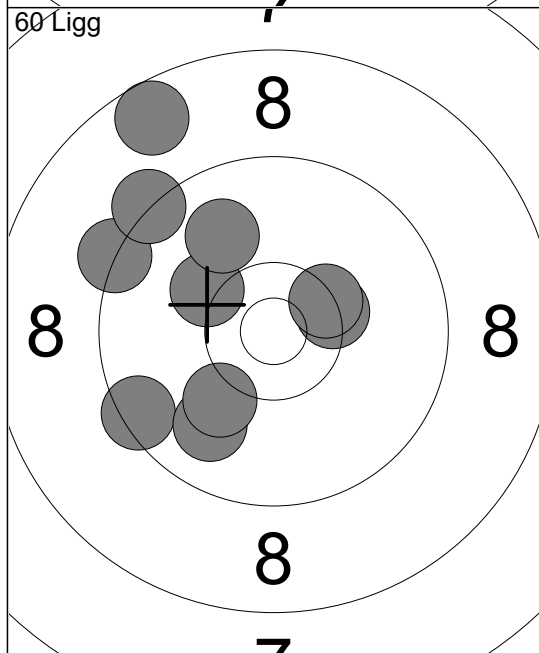

41:	8.6	↖
42:	9.5	←
43:	9.9	↘
44:	10.1	↘
45:	10.4	↗
46:	10.2	↖
47:	10.4	↗
48:	9.3	←
49:	9.9	↑
50:	9.3	↖
Serie		97.6
Total		487.3

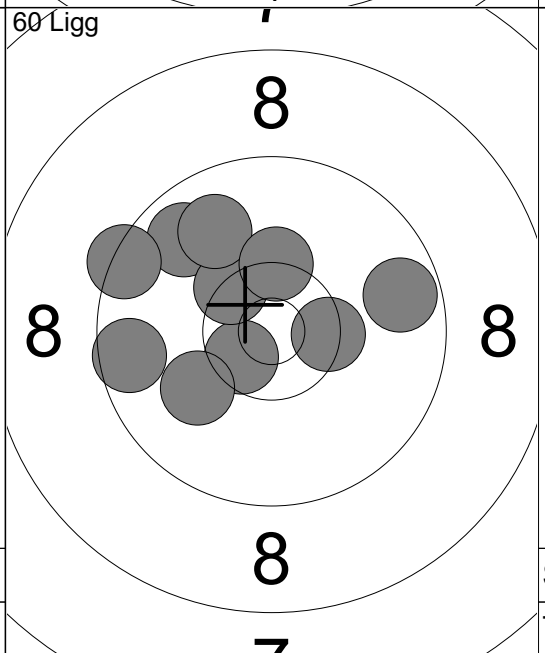

51:	9.6	←
52:	9.8	↖
53:	9.7	→
54:	9.4	←
55:	10.4	↗
56:	10.6	↘
57:	10.4	↘
58:	9.9	↖
59:	10.3	↗
60:	10.1	↘
Serie		100.2
Total		587.5

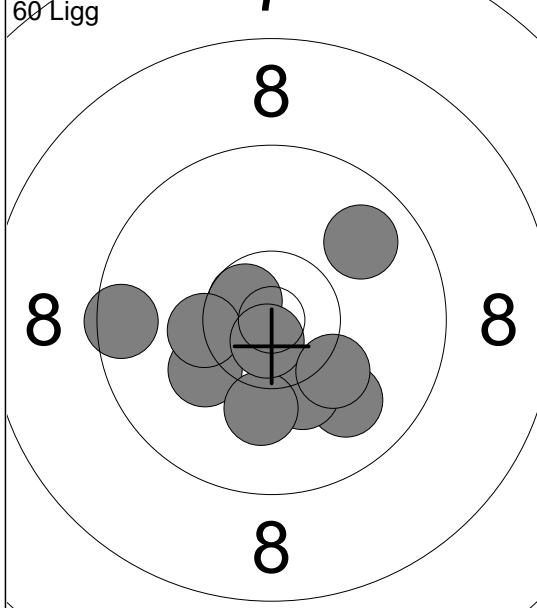

1:	9.9	↘
2:	10.2	↘
3:	10.6	↗
4:	10.2	↙
5:	9.8	↗
6:	10.1	↘
7:	10.3	↗
8:	10.7	↘
9:	9.5	←
10:	10.2	↘
Serie		101.5
Total		101.5

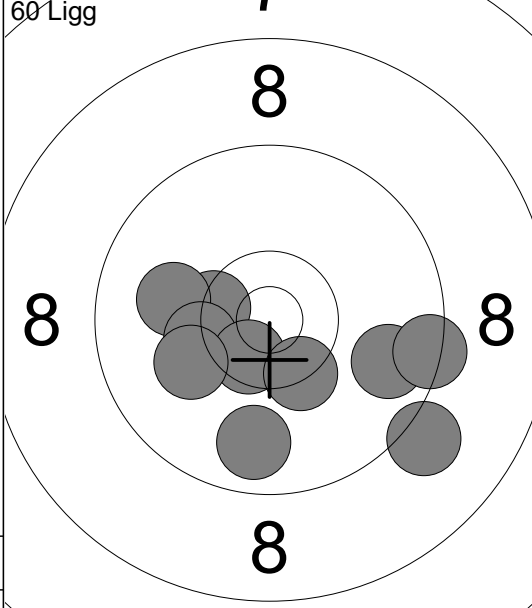

11:	9.8	↗
12:	10.4	↗
13:	9.4	↗
14:	10.0	↙
15:	9.8	↘
16:	10.3	↙
17:	9.1	↘
18:	10.5	↘
19:	10.1	↙
20:	10.4	↘
Serie		99.8
Total		201.3

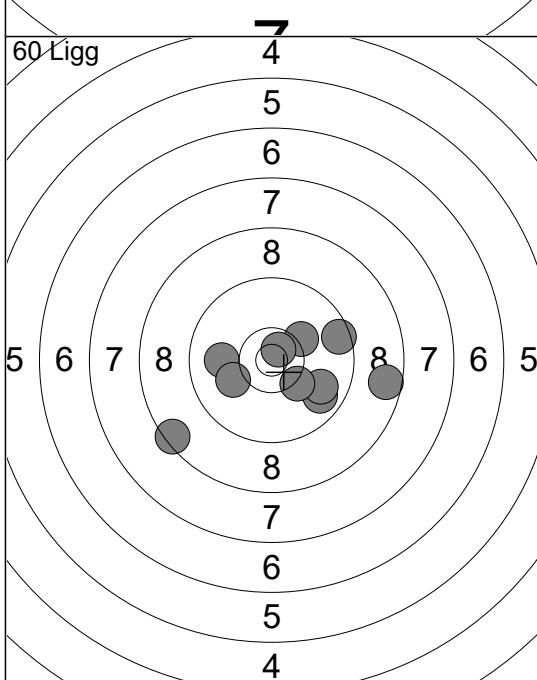

21:	9.7	↘
22:	9.8	↗
23:	10.0	←
24:	8.6	↗
25:	10.2	↗
26:	9.5	↗
27:	10.3	↘
28:	10.7	↗
29:	8.4	↙
30:	10.1	↙
Serie		97.3
Total		298.6

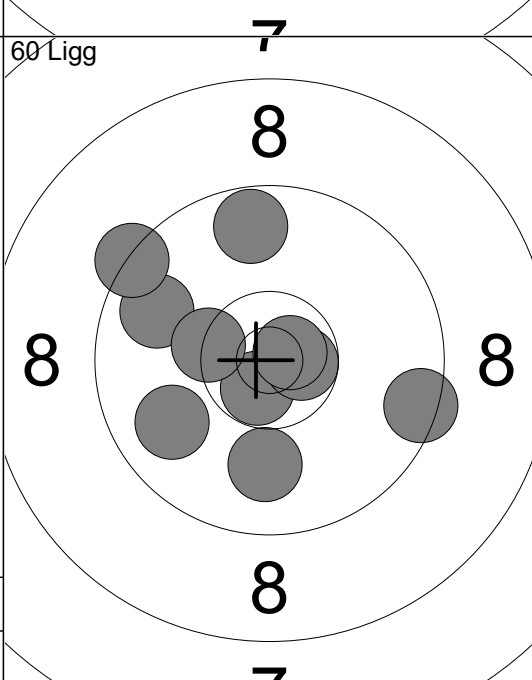

31:	9.8	←
32:	10.0	↘
33:	10.7	↘
34:	9.3	↙
35:	9.7	↑
36:	10.6	↗
37:	9.5	↗
38:	10.4	↗
39:	9.9	↙
40:	10.7	↗
Serie		100.6
Total		399.2

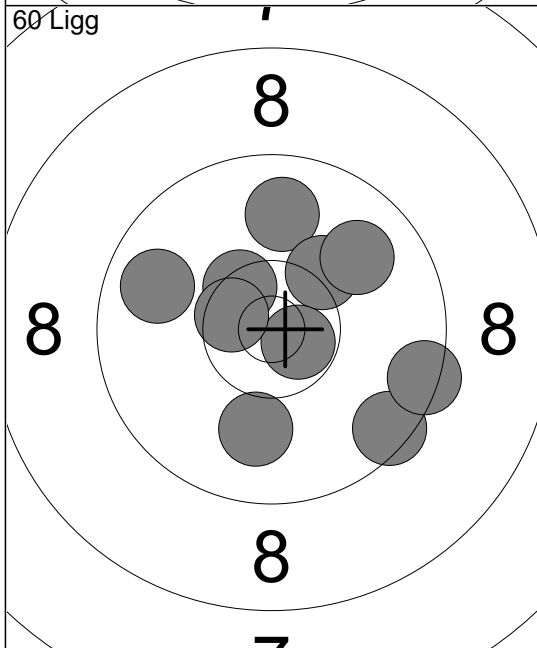

41:	9.5	↘
42:	9.9	↑
43:	9.4	↗
44:	10.2	↗
45:	9.8	↙
46:	9.9	↗
47:	10.5	↗
48:	10.7	↗
49:	10.0	↘
50:	10.5	↗
Serie		100.4
Total		499.6

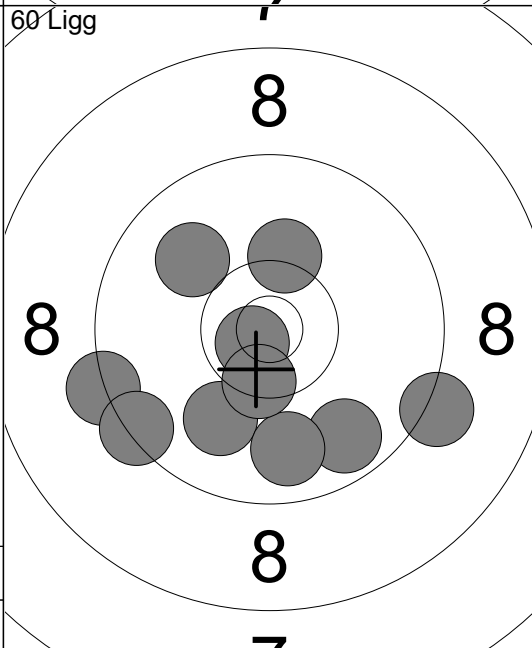

51:	10.0	↘
52:	10.2	↑
53:	9.2	↗
54:	9.7	↘
55:	10.7	↗
56:	9.8	↘
57:	10.0	↙
58:	10.4	↘
59:	9.3	←
60:	9.4	↙
Serie		98.7
Total		598.3



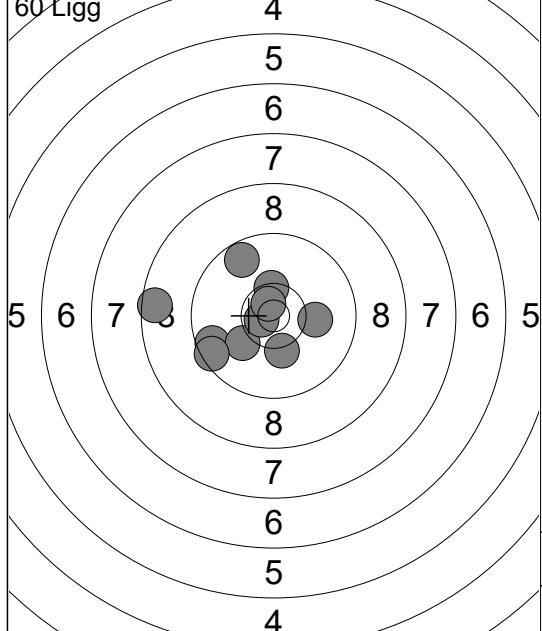

1:	10.1 →
2:	8.6 ←
3:	9.6 ←
4:	10.1 ↙
5:	10.2 ↓
6:	9.5 ←
7:	10.7 ✕
8:	10.4 ✕ ↑
9:	9.7 ↗
10:	10.7 ✕ ↘
Serie 99.6	
Total 99.6	

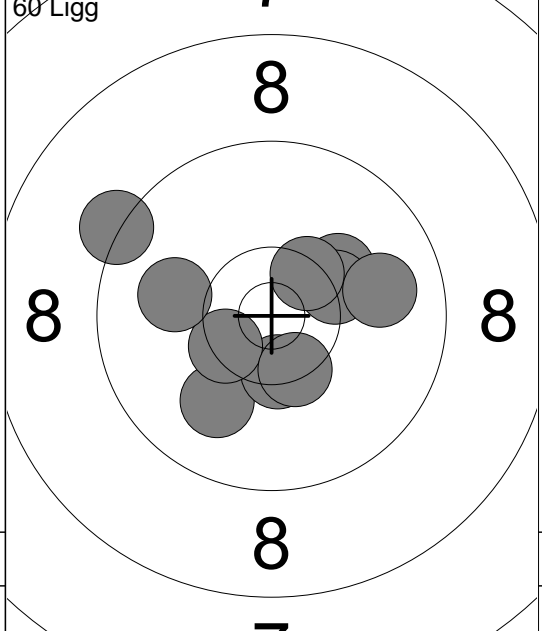

11:	10.2 ↗
12:	10.3 ✕ ↗
13:	9.9 →
14:	10.0 ↓
15:	10.4 ✕ ↓
16:	9.3 ←
17:	10.4 ✕ ↘
18:	10.0 ←
19:	10.4 ✕ ↓
20:	10.4 ✕ ↗
Serie 101.3	
Total 200.9	

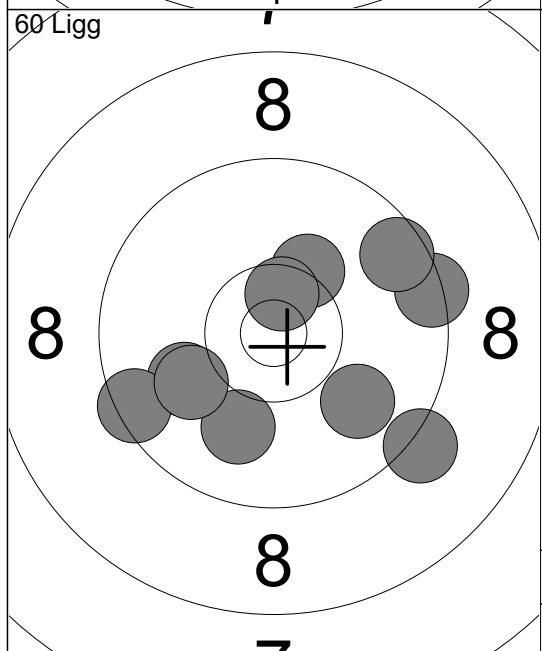

21:	10.0 ↙
22:	9.5 ←
23:	10.0 ↓
24:	9.9 ↘
25:	9.2 ↘
26:	10.3 ↗
27:	9.4 →
28:	10.0 ↙
29:	9.6 ↗
30:	10.6 ✕ ↑
Serie 98.5	
Total 299.4	

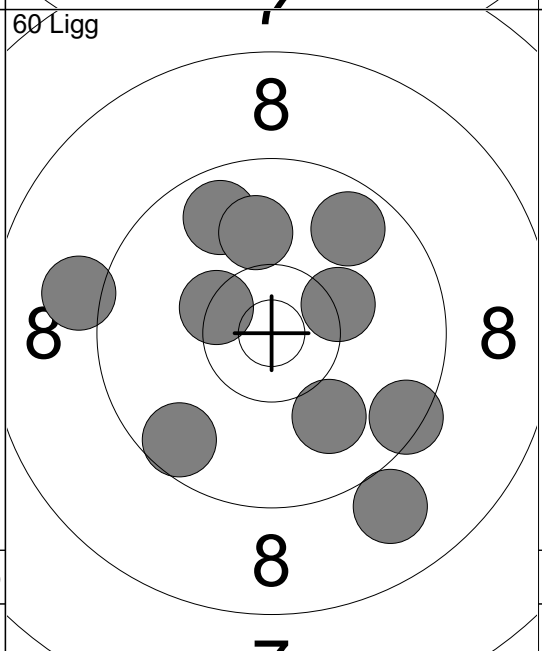

31:	10.0 ↓
32:	9.5 ↘
33:	9.1 ←
34:	9.7 ↗
35:	9.6 ↙
36:	9.8 ↗
37:	10.0 ↑
38:	10.3 ↗
39:	10.4 ✕ ↘
40:	9.0 ↓
Serie 97.4	
Total 396.8	

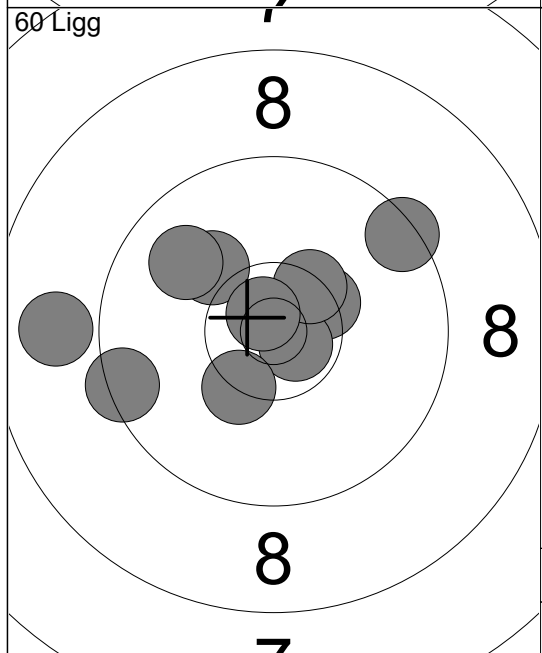

41:	10.1 ↙
42:	9.4 ↗
43:	9.9 ←
44:	10.4 ✕ ↗
45:	10.7 ✕ ↘
46:	8.9 ←
47:	10.3 ✕ ↓
48:	10.4 ✕ ↗
49:	10.8 ✕ ↘
50:	9.4 ←
Serie 100.3	
Total 497.1	

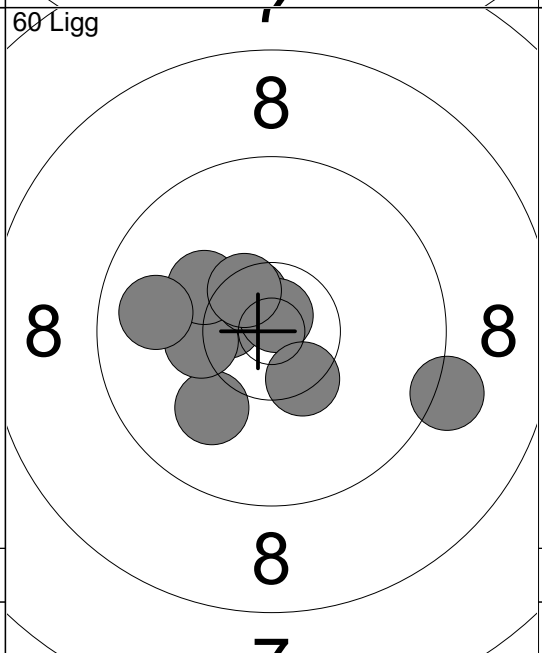

51:	10.0 ↙
52:	9.2 ↘
53:	10.5 ✕ ↘
54:	10.3 ←
55:	10.2 ↙
56:	10.6 ✕ ↘
57:	9.8 ←
58:	10.8 ✕ ↑
59:	10.4 ✕ ↓
60:	10.5 ✕ ↘
Serie 102.3	
Total 599.4	

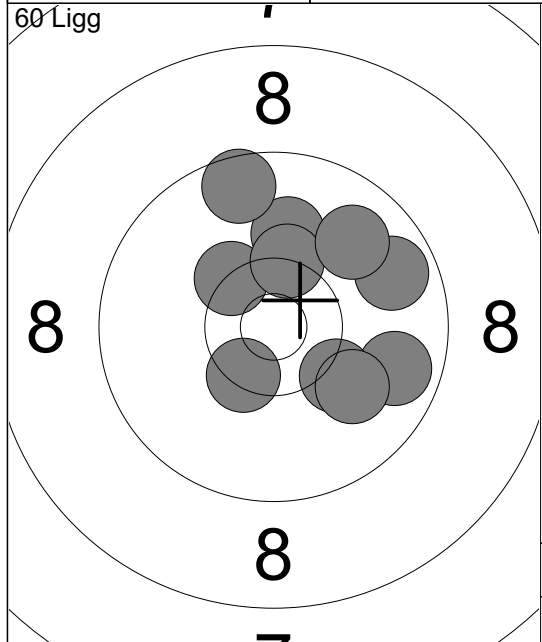

1:	10.1	↑
2:	10.4	↘
3:	9.7	→
4:	9.6	↑
5:	10.2	↘
6:	10.0	↘
7:	10.3	↘
8:	10.3	↗
9:	9.7	→
10:	9.9	↗
Serie		100.2
Total		100.2

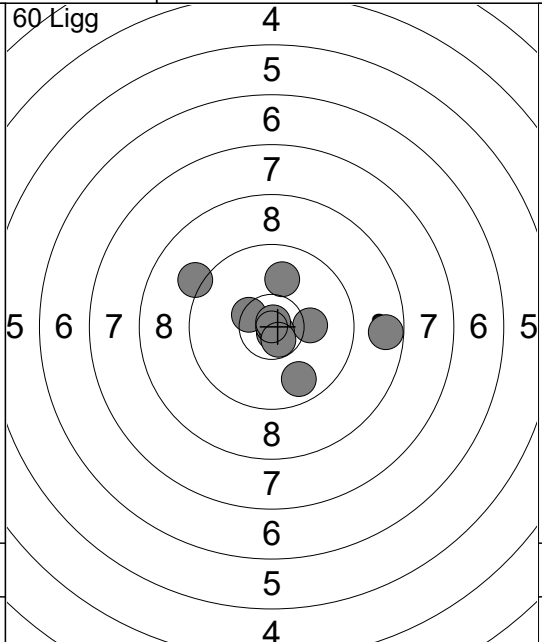

11:	8.7	→
12:	9.1	↖
13:	10.2	→
14:	10.8	↘
15:	9.8	↘
16:	10.0	↑
17:	10.8	↘
18:	10.4	↘
19:	10.9	↗
20:	10.7	↘
Serie		101.4
Total		201.6

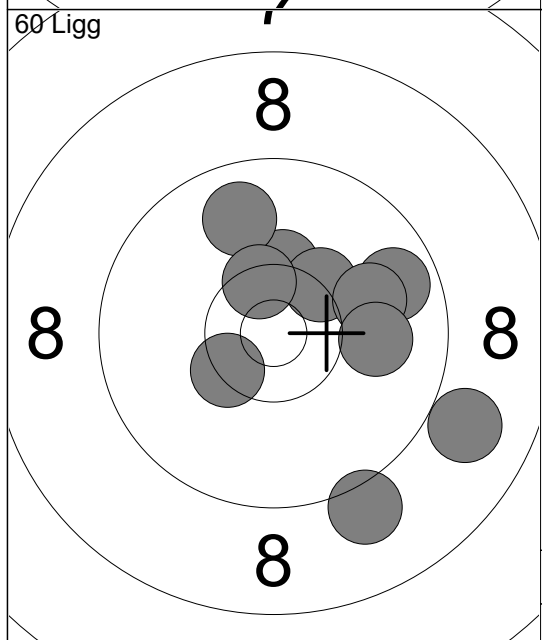

21:	10.3	↗
22:	9.7	→
23:	10.3	↗
24:	8.9	→
25:	10.0	→
26:	9.1	↘
27:	9.8	↑
28:	10.4	↗
29:	10.4	↘
30:	10.0	→
Serie		98.9
Total		300.5

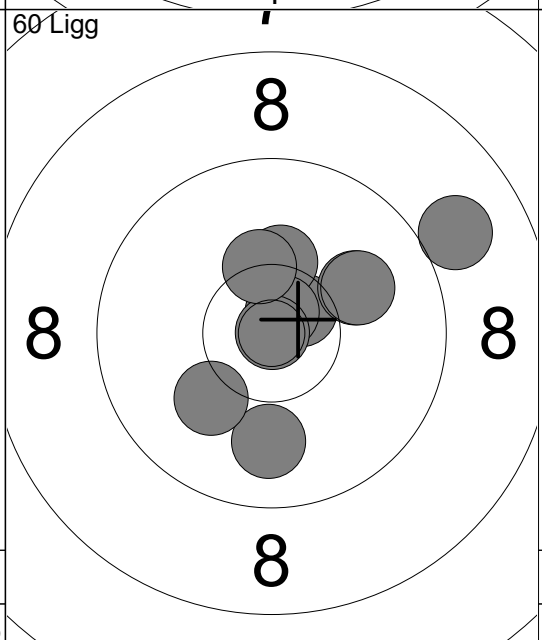

31:	10.6	↗
32:	10.3	↑
33:	10.1	↗
34:	10.7	↗
35:	10.9	↗
36:	9.0	→
37:	10.0	↗
38:	10.3	↗
39:	9.9	↘
40:	10.1	↘
Serie		101.9
Total		402.4

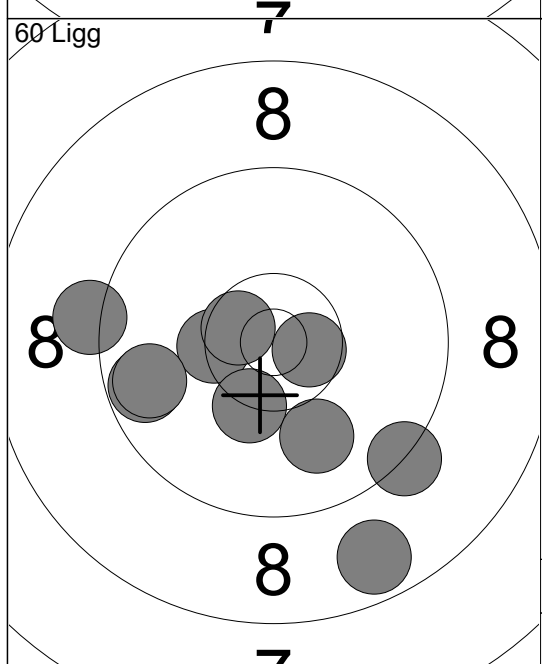

41:	9.3	↘
42:	10.4	↘
43:	10.3	↘
44:	8.7	↘
45:	9.2	←
46:	10.6	↘
47:	10.0	↘
48:	9.7	←
49:	10.6	↘
50:	9.7	←
Serie		98.5
Total		500.9

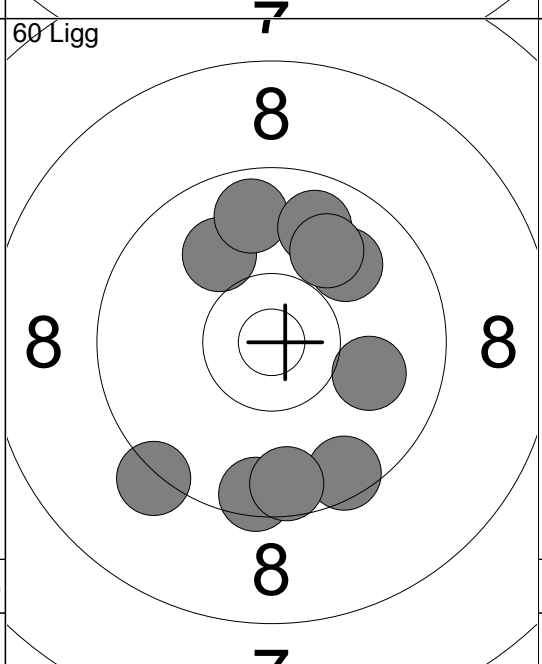

51:	10.0	↖
52:	9.7	↑
53:	9.5	↘
54:	9.8	↑
55:	9.3	↘
56:	9.9	↗
57:	9.5	↘
58:	10.0	→
59:	9.9	↗
60:	9.6	↘
Serie		97.2
Total		598.1

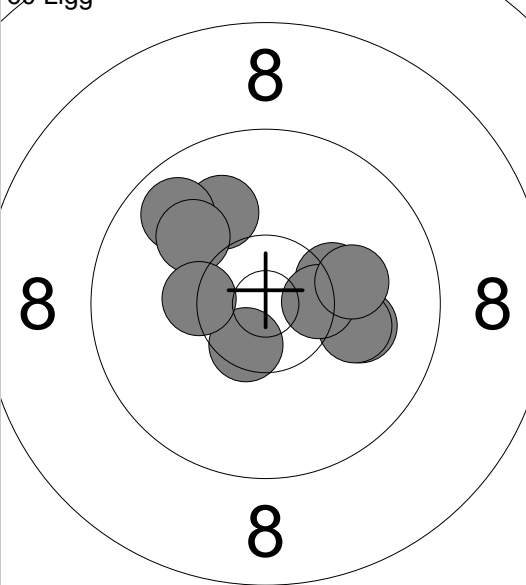
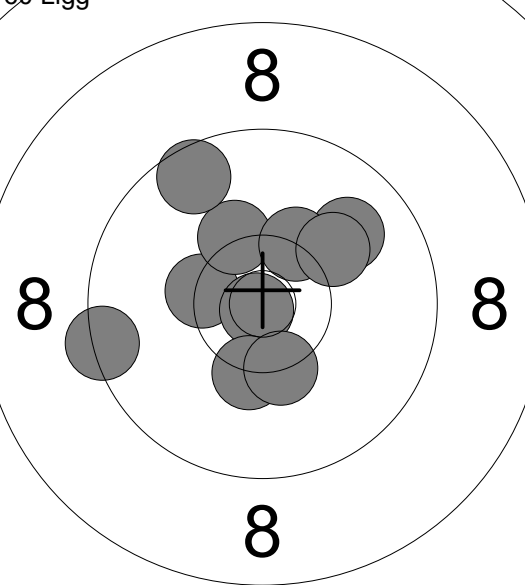
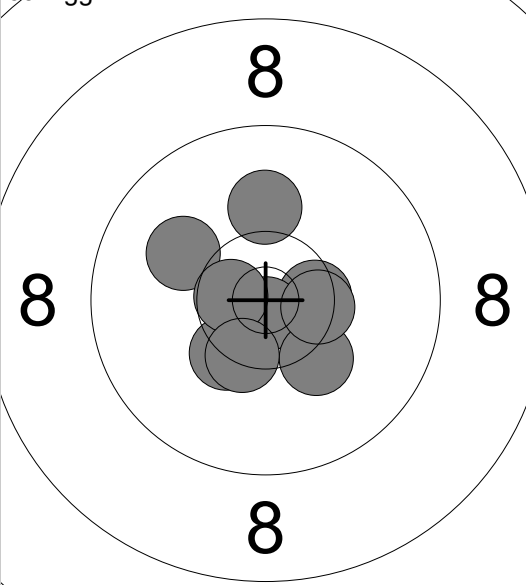
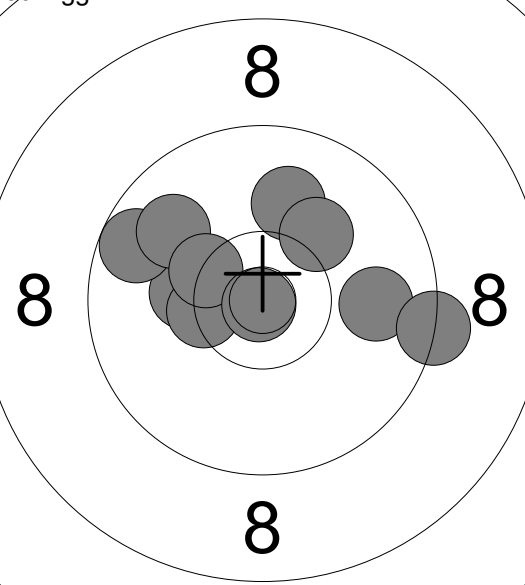
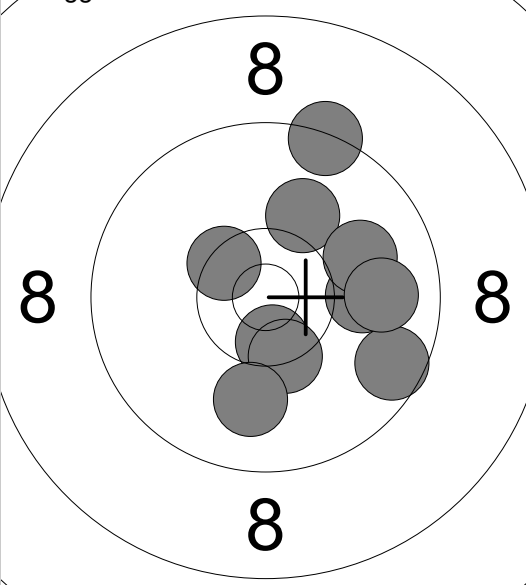
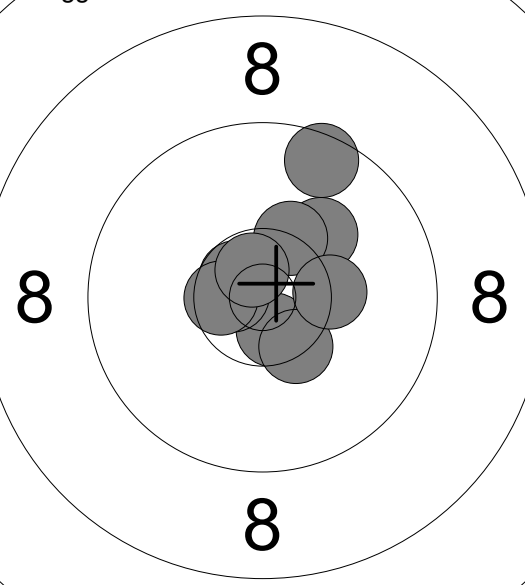
<p>60 Ligg</p>  <p style="text-align: center;">7</p>	<p>1: 10.5x ↘</p> <p>2: 10.0 →</p> <p>3: 10.3 →</p> <p>4: 10.1 →</p> <p>5: 10.4x →</p> <p>6: 10.0 ↗</p> <p>7: 10.1 →</p> <p>8: 9.8 ↖</p> <p>9: 10.0 ↖</p> <p>10: 10.3x ↘</p> <hr/> <p>Serie 101.5</p> <hr/> <p>Total 101.5</p>	<p>60 Ligg</p>  <p style="text-align: center;">7</p>	<p>11: 10.4x ↘</p> <p>12: 10.9x ↘</p> <p>13: 10.3 ↗</p> <p>14: 9.9 ↗</p> <p>15: 9.6 ↖</p> <p>16: 9.4 ←</p> <p>17: 10.3x ↘</p> <p>18: 10.3x ↗</p> <p>19: 10.1 ↗</p> <p>20: 10.3x ↘</p> <hr/> <p>Serie 101.5</p> <hr/> <p>Total 203.0</p>
<p>60 Ligg</p>  <p style="text-align: center;">7</p>	<p>21: 10.1 ↑</p> <p>22: 10.1 ↖</p> <p>23: 10.5x →</p> <p>24: 10.7x ↘</p> <p>25: 10.8x ↘</p> <p>26: 10.3x ↘</p> <p>27: 10.2 ↘</p> <p>28: 10.5x →</p> <p>29: 10.6x ↘</p> <p>30: 10.4x ↘</p> <hr/> <p>Serie 104.2</p> <hr/> <p>Total 307.2</p>	<p>60 Ligg</p>  <p style="text-align: center;">7</p>	<p>31: 10.0 ↑</p> <p>32: 10.2 ←</p> <p>33: 9.7 ↖</p> <p>34: 9.9 ↖</p> <p>35: 9.9 →</p> <p>36: 10.4x ↘</p> <p>37: 9.3 →</p> <p>38: 10.3x ↘</p> <p>39: 10.9x ↘</p> <p>40: 10.2 ↗</p> <hr/> <p>Serie 100.8</p> <hr/> <p>Total 408.0</p>
<p>60 Ligg</p>  <p style="text-align: center;">7</p>	<p>41: 10.5x ↘</p> <p>42: 10.4x ↘</p> <p>43: 10.0 →</p> <p>44: 10.4x ↘</p> <p>45: 9.3 ↗</p> <p>46: 9.6 →</p> <p>47: 10.1 ↗</p> <p>48: 10.0 →</p> <p>49: 10.0 ↓</p> <p>50: 9.9 →</p> <hr/> <p>Serie 100.2</p> <hr/> <p>Total 508.2</p>	<p>60 Ligg</p>  <p style="text-align: center;">7</p>	<p>51: 10.6x ↘</p> <p>52: 10.6x ↘</p> <p>53: 10.4x ↘</p> <p>54: 10.1 ↗</p> <p>55: 10.3x ↗</p> <p>56: 10.7x ↘</p> <p>57: 10.6x ↘</p> <p>58: 10.3x →</p> <p>59: 10.7x ↗</p> <p>60: 9.5 ↗</p> <hr/> <p>Serie 103.8</p> <hr/> <p>Total 612.0</p>

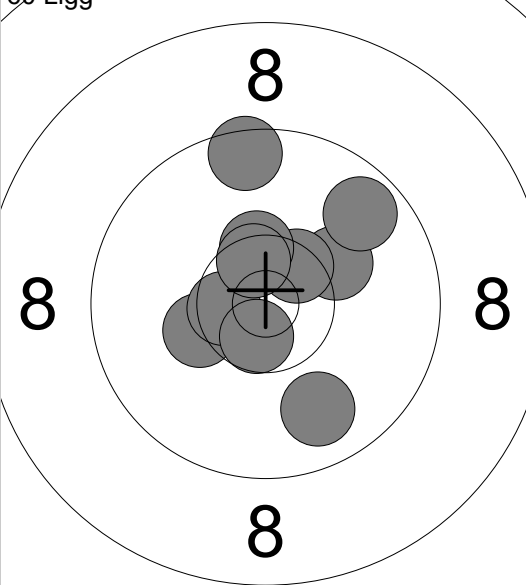
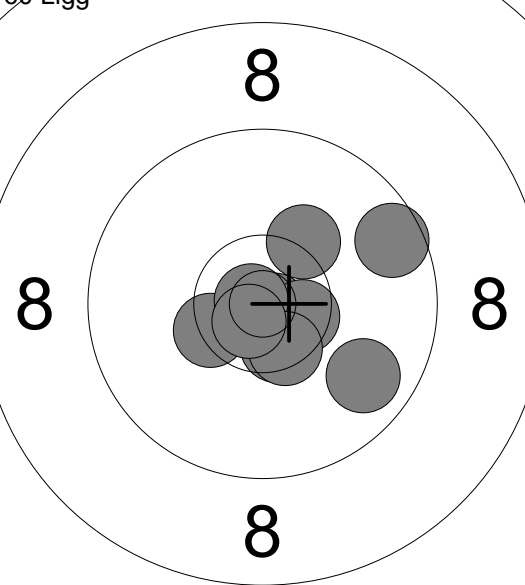
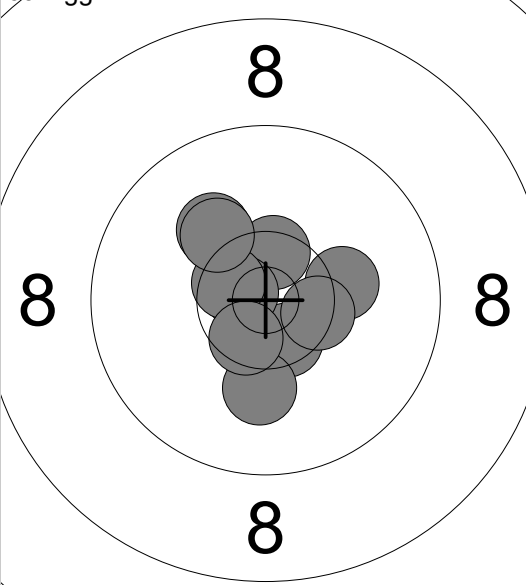
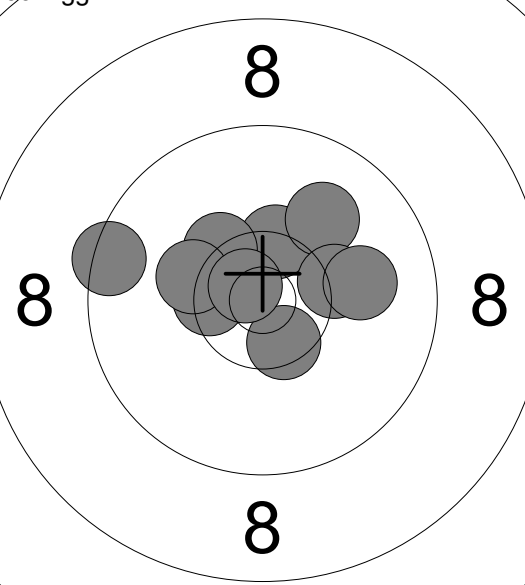
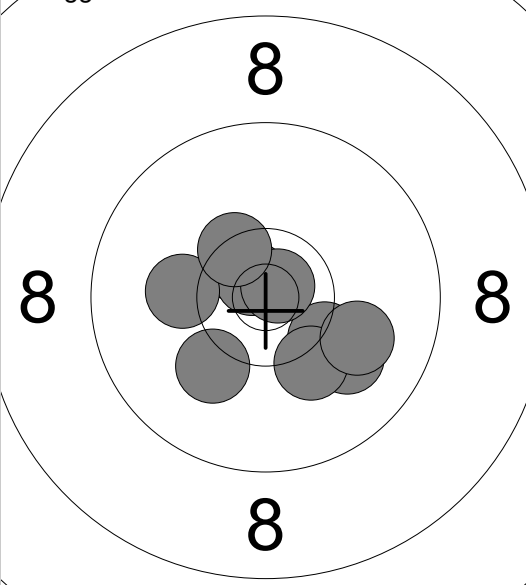
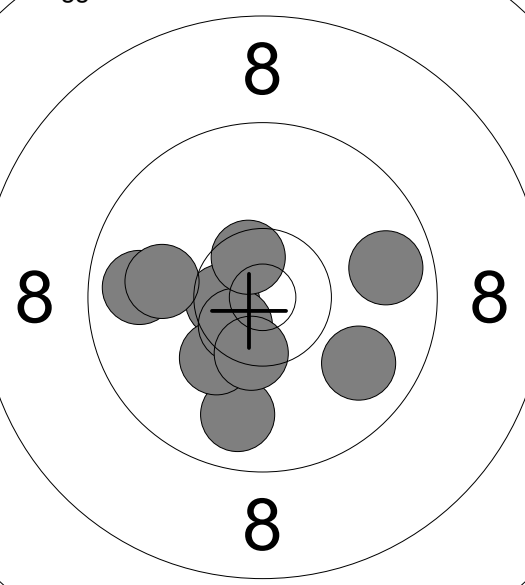
<p>60 Ligg</p>  <p style="text-align: center;">7</p>	<p>1: 10.3 ←</p> <p>2: 9.8 ↓</p> <p>3: 9.5 ↑</p> <p>4: 10.2 →</p> <p>5: 10.6 ✕</p> <p>6: 10.5 ↗</p> <p>7: 10.4x ↑</p> <p>8: 9.7 ↗</p> <p>9: 10.5x ↑</p> <p>10: 10.6x ↓</p> <p>Serie 102.1</p> <p>Total 102.1</p>	<p>60 Ligg</p>  <p style="text-align: center;">7</p>	<p>11: 10.4x ✕</p> <p>12: 10.2 ↗</p> <p>13: 10.5x ↓</p> <p>14: 10.8x ↘</p> <p>15: 9.8 ↘</p> <p>16: 10.6x →</p> <p>17: 9.6 →</p> <p>18: 10.8 ✕</p> <p>19: 10.5x ↓</p> <p>20: 10.7x ↓</p> <p>Serie 103.9</p> <p>Total 206.0</p>
<p>60 Ligg</p>  <p style="text-align: center;">7</p>	<p>21: 10.5x ↓</p> <p>22: 10.1 ↓</p> <p>23: 10.2 →</p> <p>24: 10.5x ↑</p> <p>25: 10.4x →</p> <p>26: 10.7 ✕</p> <p>27: 10.1 ↖</p> <p>28: 10.6 ✕</p> <p>29: 10.5x ↓</p> <p>30: 10.2 ↖</p> <p>Serie 103.8</p> <p>Total 309.8</p>	<p>60 Ligg</p>  <p style="text-align: center;">7</p>	<p>31: 10.4x ↑</p> <p>32: 10.4 ✕</p> <p>33: 10.5x ↓</p> <p>34: 10.3x ↖</p> <p>35: 10.0 ↗</p> <p>36: 9.4 ←</p> <p>37: 10.3 ←</p> <p>38: 10.7 ✕</p> <p>39: 10.3 →</p> <p>40: 10.0 →</p> <p>Serie 102.3</p> <p>Total 412.1</p>
<p>60 Ligg</p>  <p style="text-align: center;">7</p>	<p>41: 10.3 ↘</p> <p>42: 10.0 ↘</p> <p>43: 10.5x ↖</p> <p>44: 10.7x ↖</p> <p>45: 10.2 ↓</p> <p>46: 10.1 ↖</p> <p>47: 10.0 →</p> <p>48: 10.8x ↗</p> <p>49: 10.2 ←</p> <p>50: 10.4x ↖</p> <p>Serie 103.2</p> <p>Total 515.3</p>	<p>60 Ligg</p>  <p style="text-align: center;">7</p>	<p>51: 9.8 ↓</p> <p>52: 10.6 ✕</p> <p>53: 10.2 ↓</p> <p>54: 10.6x ↓</p> <p>55: 9.8 ←</p> <p>56: 9.8 →</p> <p>57: 10.0 ←</p> <p>58: 9.9 ↘</p> <p>59: 10.4x ↓</p> <p>60: 10.5x ↖</p> <p>Serie 101.6</p> <p>Total 616.9</p>

<p>60 Ligg</p>	<p>1: 9.7 ←                  2: 9.6 →                  3: 10.2 ↓                  4: 10.0 ↓                  5: 10.2 ↖                  6: 9.1 ↓                  7: 10.9 ↗                  8: 9.3 ↓                  9: 10.3 ↖                  10: 10.1 ↑</p> <p>Serie 99.4</p> <p>Total 99.4</p>	<p>60 Ligg</p>	<p>11: 10.5x ↓                  12: 10.7x →                  13: 9.5 ↖                  14: 10.1 ↓                  15: 9.5 →                  16: 10.2 ↗                  17: 10.4x ↗                  18: 10.4x ↖                  19: 10.8x ↗                  20: 10.3 ←</p> <p>Serie 102.4</p> <p>Total 201.8</p>
<p>60 Ligg</p>	<p>21: 9.6 ↖                  22: 10.5x ↘                  23: 10.3x ↗                  24: 9.9 ←                  25: 9.8 ↓                  26: 10.8x ↘                  27: 10.0 ↗                  28: 10.4x ↑                  29: 10.3 ↗                  30: 10.6x ↖</p> <p>Serie 102.2</p> <p>Total 304.0</p>	<p>60 Ligg</p>	<p>31: 10.5x ↑                  32: 10.4x ↖                  33: 10.5x ↖                  34: 9.7 →                  35: 10.0 ←                  36: 10.6x ↖                  37: 10.4x ↗                  38: 10.4x ↗                  39: 10.1 ←                  40: 9.9 ←</p> <p>Serie 102.5</p> <p>Total 406.5</p>
<p>60 Ligg</p>	<p>41: 10.2 ↓                  42: 9.9 ↓                  43: 10.3 ↗                  44: 10.4x ↖                  45: 10.0 ↖                  46: 9.5 ↓                  47: 10.2 ←                  48: 10.3x ↖                  49: 10.0 →                  50: 10.5x ↖</p> <p>Serie 101.3</p> <p>Total 507.8</p>	<p>60 Ligg</p>	<p>51: 10.5x ↘                  52: 10.3 ↓                  53: 8.5 ↓                  54: 10.4x ↗                  55: 9.1 ←                  56: 10.2 ←                  57: 10.1 →                  58: 9.5 →                  59: 9.9 ↓                  60: 9.9 ↑</p> <p>Serie 98.4</p> <p>Total 606.2</p>

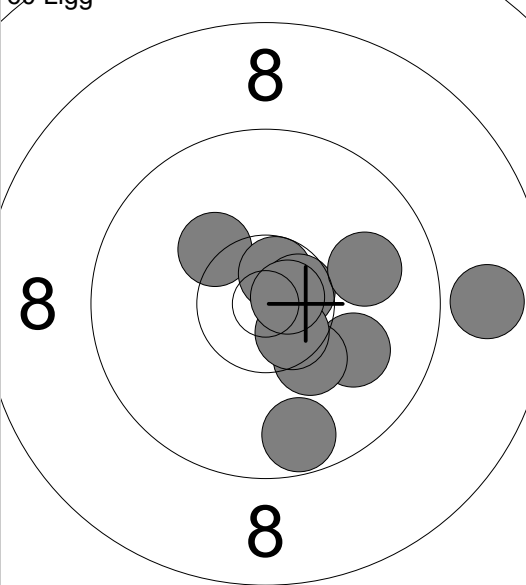
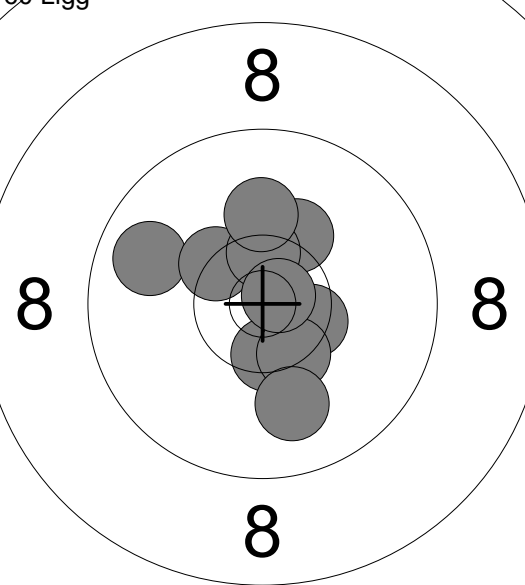
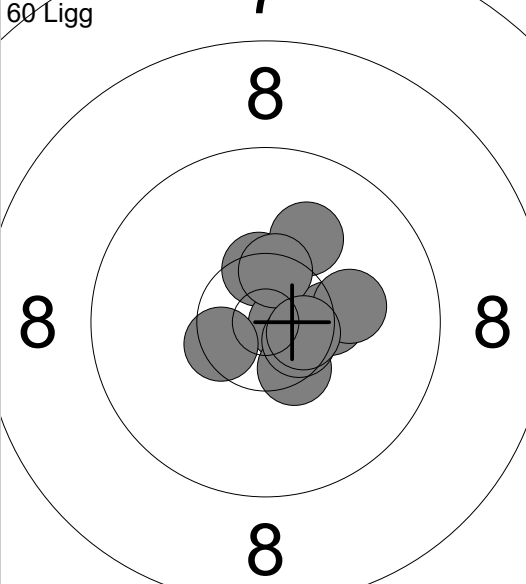
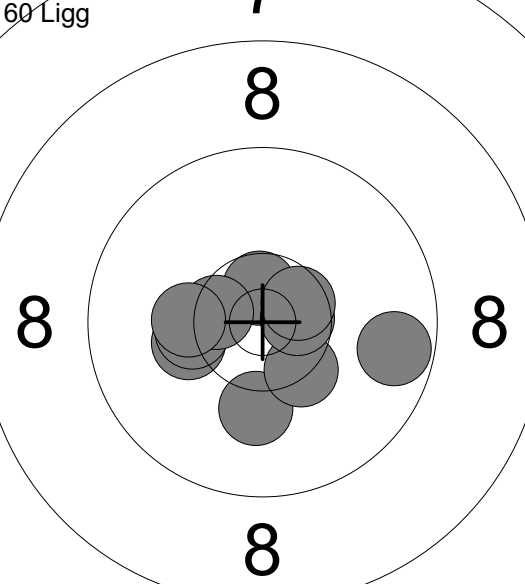
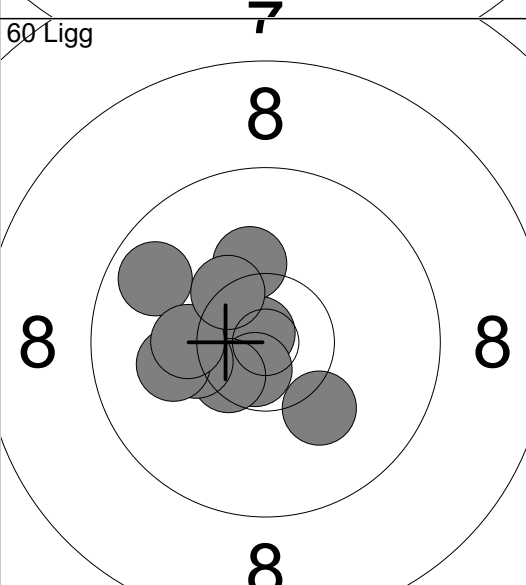
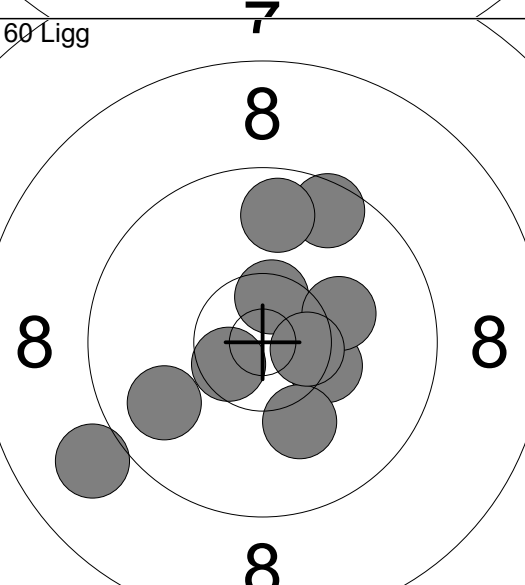
<p>60 Ligg</p> 	<p>1: 10.2 ↖                  2: 10.7x ↗                  3: 10.6x →                  4: 9.7 ↓                  5: 10.0 →                  6: 10.3x ↘                  7: 8.9 →                  8: 10.6x ↘                  9: 10.0 →                  10: 10.7x →</p> <p>Serie 101.7                  Total 101.7</p>	<p>60 Ligg</p> 	<p>11: 9.8 ↖                  12: 10.2 ↗                  13: 10.4x ↘                  14: 10.5x →                  15: 10.5x ↗                  16: 10.5x ↓                  17: 10.4x ↘                  18: 10.1 ↑                  19: 10.0 ↓                  20: 10.8x →</p> <p>Serie 103.2                  Total 204.9</p>
<p>60 Ligg</p> 	<p>21: 10.4x ↗                  22: 10.8x →                  23: 10.5x ↘                  24: 10.4x ↘                  25: 10.3x →                  26: 10.1 ↗                  27: 10.5x ↗                  28: 10.1 →                  29: 10.6x ↘                  30: 10.6x →</p> <p>Serie 104.3                  Total 309.2</p>	<p>60 Ligg</p> 	<p>31: 10.1 ↓                  32: 10.2 ↖                  33: 10.6x ↗                  34: 10.4x ↘                  35: 10.3 ↖                  36: 9.7 →                  37: 10.5x ↘                  38: 10.6x →                  39: 10.6x →                  40: 10.2 ↖</p> <p>Serie 103.2                  Total 412.4</p>
<p>60 Ligg</p> 	<p>41: 10.8x ↘                  42: 10.7x ↘                  43: 10.5x ↘                  44: 9.7 ↖                  45: 10.3 ↖                  46: 10.1 ↖                  47: 10.2 ↖                  48: 10.1 ↓                  49: 10.2 ↑                  50: 10.4x ↘</p> <p>Serie 103.0                  Total 515.4</p>	<p>60 Ligg</p> 	<p>51: 10.6x ↘                  52: 10.3x →                  53: 10.5x ↗                  54: 9.0 ↖                  55: 10.2 →                  56: 9.6 ↗                  57: 9.7 ↗                  58: 10.1 ↓                  59: 9.9 ↖                  60: 10.5x →</p> <p>Serie 100.4                  Total 615.8</p>

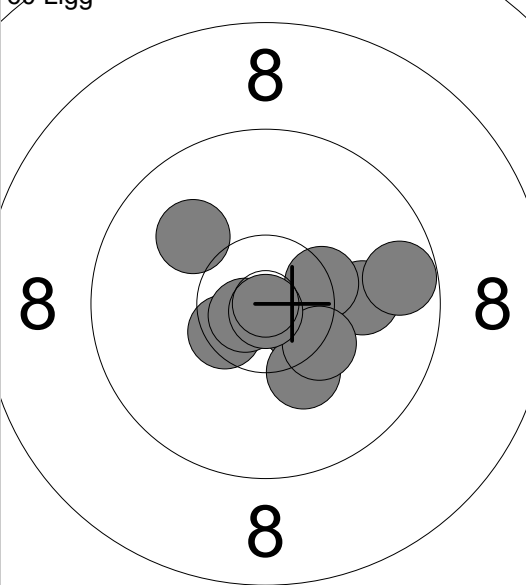
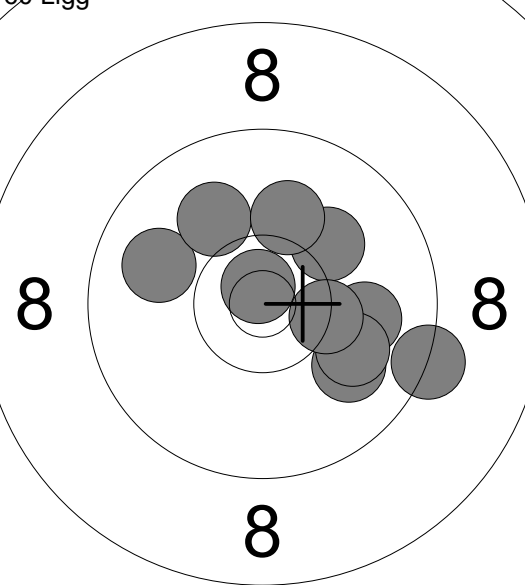
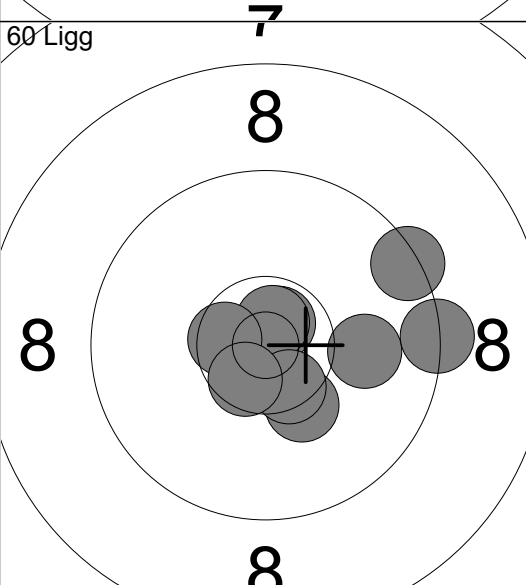
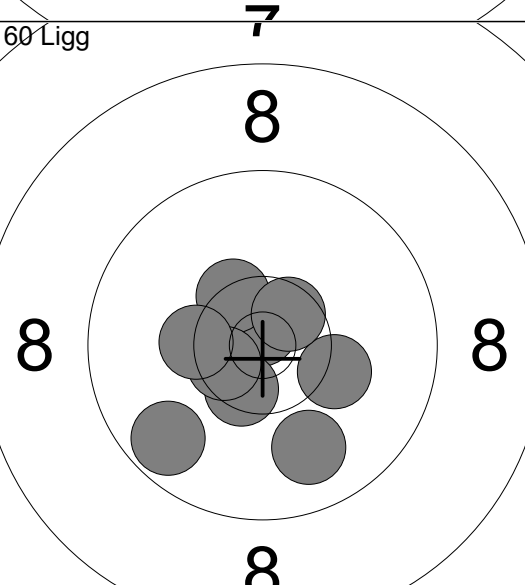
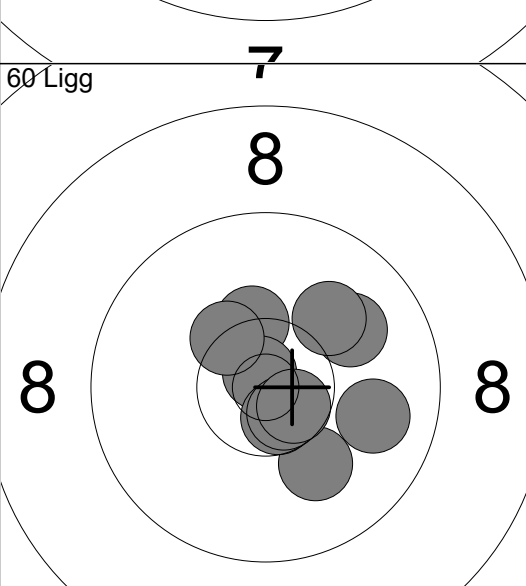
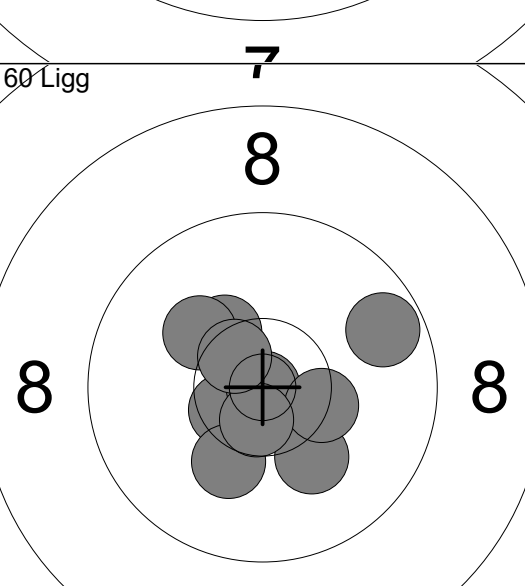
<p>60 Ligg</p> 	<p>1: 10.6x↘ 2: 10.0→ 3: 10.5↙ 4: 10.2↓ 5: 10.0↖ 6: 10.4x→ 7: 10.7x↙ 8: 10.3x↘ 9: 10.9x↓ 10: 9.7 →</p> <p>Serie 103.3 Total 103.3</p>	<p>60 Ligg</p> 	<p>11: 9.9 ↖ 12: 10.0→ 13: 10.0↘ 14: 10.0↗ 15: 10.1↗ 16: 10.1↑ 17: 10.0↘ 18: 10.8x↑ 19: 10.3x→ 20: 9.3 →</p> <p>Serie 100.5 Total 203.8</p>
<p>60 Ligg</p> 	<p>21: 10.8x↙ 22: 10.7x↗ 23: 10.0→ 24: 9.4 ↗ 25: 9.3 → 26: 10.3x↘ 27: 10.7x↗ 28: 10.6x↖ 29: 10.5x↘ 30: 10.6x↙</p> <p>Serie 102.9 Total 306.7</p>	<p>60 Ligg</p> 	<p>31: 10.7x↖ 32: 10.2→ 33: 10.8x↑ 34: 10.4x↖ 35: 9.7 ↙ 36: 10.5x↓ 37: 10.6x↖ 38: 10.3x↖ 39: 10.6x↗ 40: 9.9 ↓</p> <p>Serie 103.7 Total 410.4</p>
<p>60 Ligg</p> 	<p>41: 10.0 ↗ 42: 10.3x↑ 43: 10.1 ↓ 44: 10.1 ↗ 45: 10.8x↑ 46: 10.6x↓ 47: 9.9 → 48: 10.7x↘ 49: 10.4x↖ 50: 10.6x↘</p> <p>Serie 103.5 Total 513.9</p>	<p>60 Ligg</p> 	<p>51: 9.7 ↗ 52: 10.5x↙ 53: 10.3x↖ 54: 10.2 ↓ 55: 10.2 ↖ 56: 10.9x↘ 57: 10.1 ↓ 58: 10.4x→ 59: 10.6x↓ 60: 10.6x↖</p> <p>Serie 103.5 Total 617.4</p>

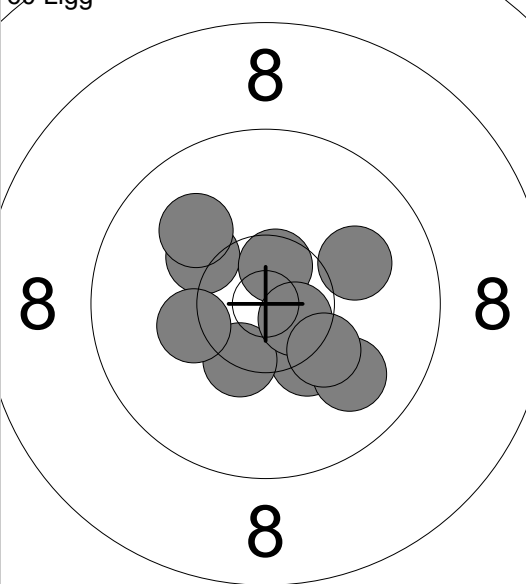
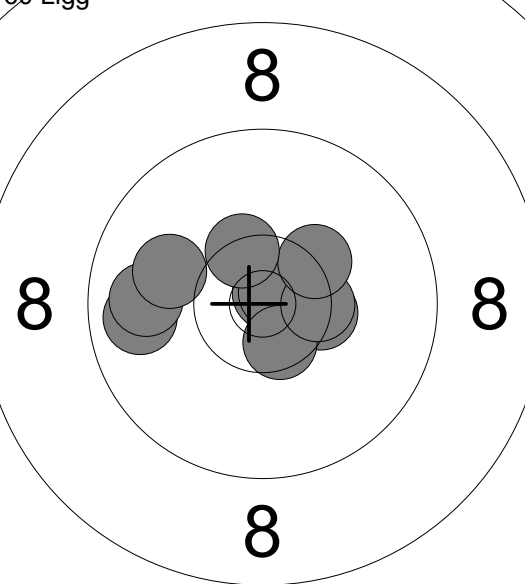
<p>60 Ligg</p>  <p style="text-align: center; font-size: 2em;">8</p>	<p>1: 10.3x ↘</p> <p>2: 10.4x ↘</p> <p>3: 10.2 ↖</p> <p>4: 10.6x ↗</p> <p>5: 10.6x →</p> <p>6: 10.2 ←</p> <p>7: 10.0 →</p> <p>8: 9.9 ↘</p> <p>9: 10.0 ↖</p> <p>10: 10.2 ↘</p> <hr/> <p>Serie 102.4</p> <hr/> <p>Total 102.4</p>	<p>60 Ligg</p>  <p style="text-align: center; font-size: 2em;">8</p>	<p>11: 10.8x ↗</p> <p>12: 9.8 ←</p> <p>13: 10.8x ↗</p> <p>14: 9.9 ←</p> <p>15: 10.4x →</p> <p>16: 10.0 ←</p> <p>17: 10.6x ↘</p> <p>18: 10.4x →</p> <p>19: 10.3x ↗</p> <p>20: 10.4x ↖</p> <hr/> <p>Serie 103.4</p> <hr/> <p>Total 205.8</p>
--	---	--	--

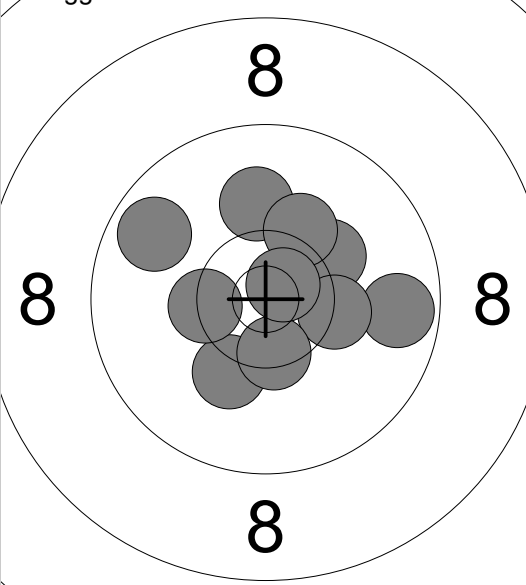
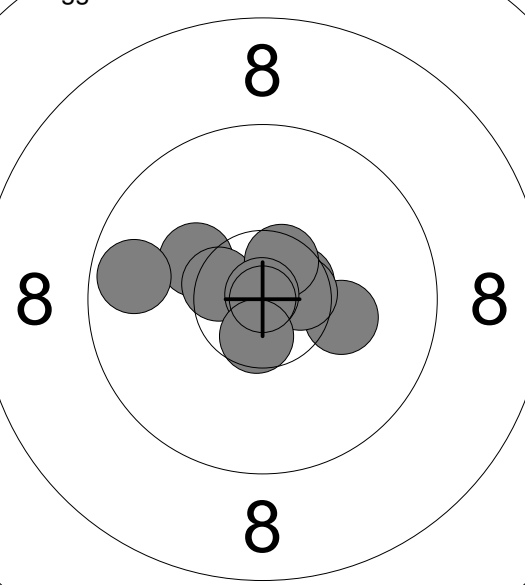
<p>60 Ligg</p>  <p style="text-align: center; font-size: 2em;">8</p>	<p>21: 9.7 →</p> <p>22: 10.2 ↗</p> <p>23: 10.3x →</p> <p>24: 10.0 ↑</p> <p>25: 9.7 ↖</p> <p>26: 10.2 ↗</p> <p>27: 10.2 ↘</p> <p>28: 10.4x ↘</p> <p>29: 10.4x ↖</p> <p>30: 10.7x ↗</p> <hr/> <p>Serie 101.8</p> <hr/> <p>Total 307.6</p>	<p>60 Ligg</p>  <p style="text-align: center; font-size: 2em;">8</p>	<p>31: 10.2 ↖</p> <p>32: 10.2 →</p> <p>33: 10.6x ↗</p> <p>34: 10.5x ↖</p> <p>35: 10.8x ↗</p> <p>36: 10.6x →</p> <p>37: 10.6x ↗</p> <p>38: 9.7 ←</p> <p>39: 10.9x ↗</p> <p>40: 10.6x ↘</p> <hr/> <p>Serie 104.7</p> <hr/> <p>Total 412.3</p>
---	---	---	---

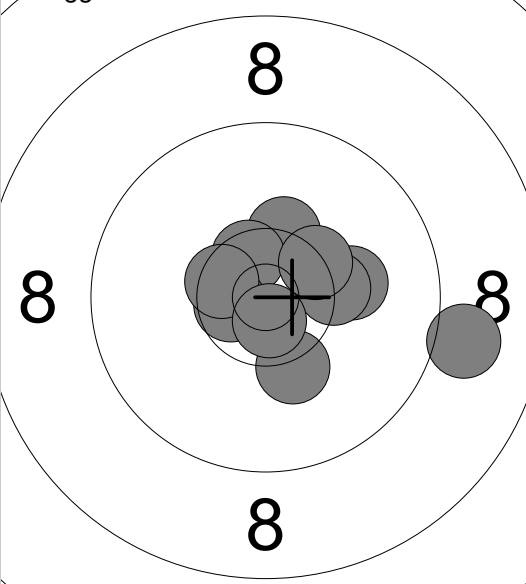
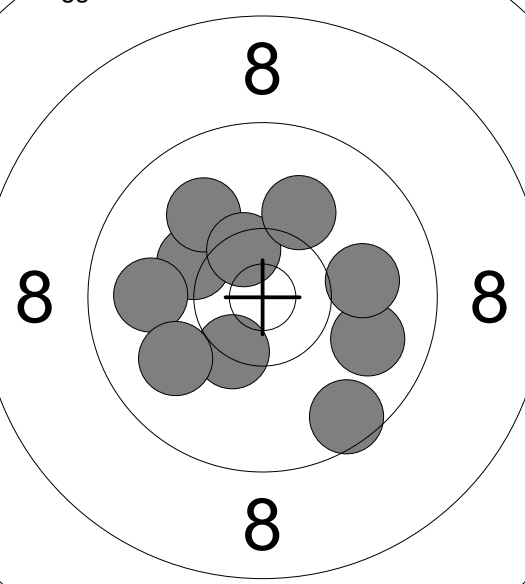
<p>60 Ligg</p>  <p style="text-align: center; font-size: 2em;">8</p>	<p>41: 10.3x ↗</p> <p>42: 9.0 →</p> <p>43: 10.5x ↘</p> <p>44: 10.6x ↖</p> <p>45: 10.1 →</p> <p>46: 10.3x →</p> <p>47: 10.5x ↖</p> <p>48: 10.2 ↘</p> <p>49: 10.7x ↘</p> <p>50: 10.4x ↗</p> <hr/> <p>Serie 102.6</p> <hr/> <p>Total 514.9</p>	<p>60 Ligg</p>  <p style="text-align: center; font-size: 2em;">8</p>	<p>51: 9.6 ↘</p> <p>52: 9.9 →</p> <p>53: 10.4x ↘</p> <p>54: 10.2 ↖</p> <p>55: 10.0 ↖</p> <p>56: 9.9 ←</p> <p>57: 10.5x ↖</p> <p>58: 10.0 →</p> <p>59: 10.1 ↗</p> <p>60: 9.9 ↖</p> <hr/> <p>Serie 100.5</p> <hr/> <p>Total 615.4</p>
--	---	--	---

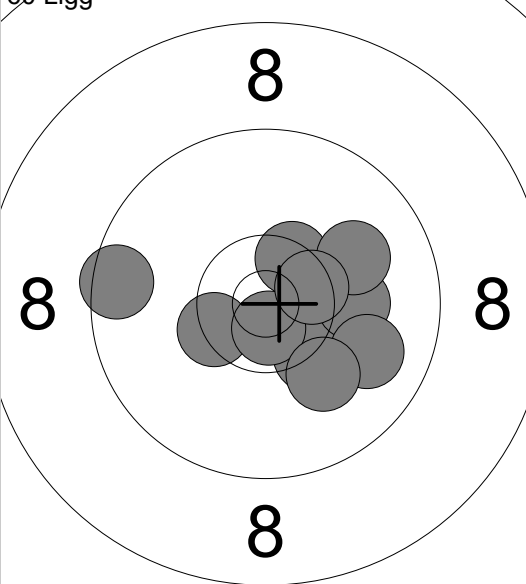
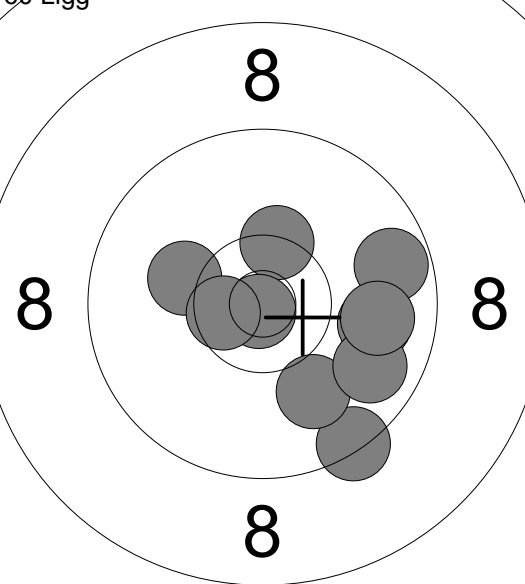

<p>60 Ligg</p>  <p style="text-align: center;"><b>8</b></p>	<p>1: 10.4x ↙</p> <p>2: 10.5x ↗</p> <p>3: 10.3x ↘</p> <p>4: 10.1 →</p> <p>5: 10.7x ↓</p> <p>6: 9.9 →</p> <p>7: 10.0 ↗</p> <p>8: 9.5 ←</p> <p>9: 10.1 ↓</p> <p>10: 10.5x ↗</p> <p>Serie 102.0</p> <p>Total 102.0</p>	<p>60 Ligg</p>  <p style="text-align: center;"><b>8</b></p>	<p>11: 10.4x ↗</p> <p>12: 9.4 ↓</p> <p>13: 10.2 ↙</p> <p>14: 10.0 ↓</p> <p>15: 9.7 →</p> <p>16: 10.9x ↓</p> <p>17: 9.9 →</p> <p>18: 9.8 ↘</p> <p>19: 9.9 →</p> <p>20: 10.6x ↙</p> <p>Serie 100.8</p> <p>Total 202.8</p>
---	---	---	---

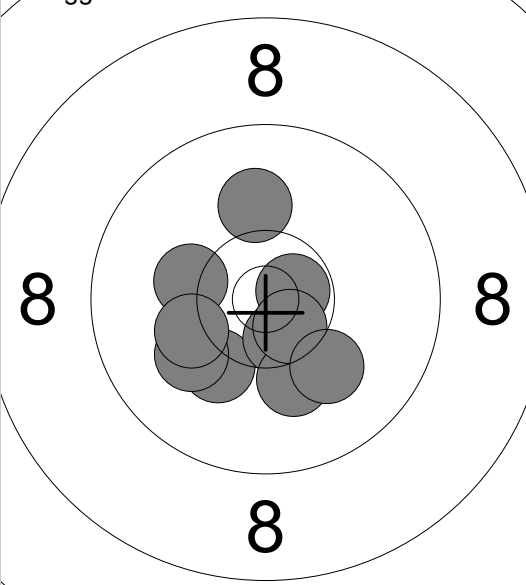
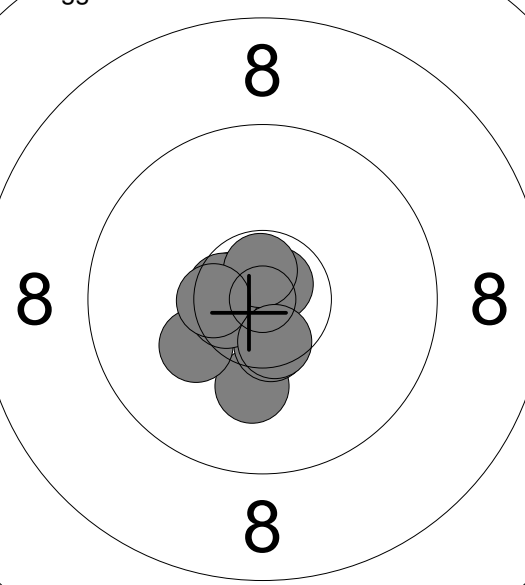
<p>60 Ligg</p>  <p style="text-align: center;"><b>8</b></p>	<p>21: 10.2 ↓</p> <p>22: 10.1 ↙</p> <p>23: 10.6x ↓</p> <p>24: 10.1 ↓</p> <p>25: 10.7x ↗</p> <p>26: 10.2 ↙</p> <p>27: 10.6x ↘</p> <p>28: 10.1 ↓</p> <p>29: 10.2 ↙</p> <p>30: 10.1 ↑</p> <p>Serie 102.9</p> <p>Total 305.7</p>	<p>60 Ligg</p>  <p style="text-align: center;"><b>8</b></p>	<p>31: 10.8x ↗</p> <p>32: 10.6x ↙</p> <p>33: 10.1 ↓</p> <p>34: 10.2 ↙</p> <p>35: 10.5x ↓</p> <p>36: 10.6x ↙</p> <p>37: 10.6x ↙</p> <p>38: 10.7x ↗</p> <p>39: 10.5x ↙</p> <p>40: 10.5x ↓</p> <p>Serie 105.1</p> <p>Total 410.8</p>
--	--	--	---

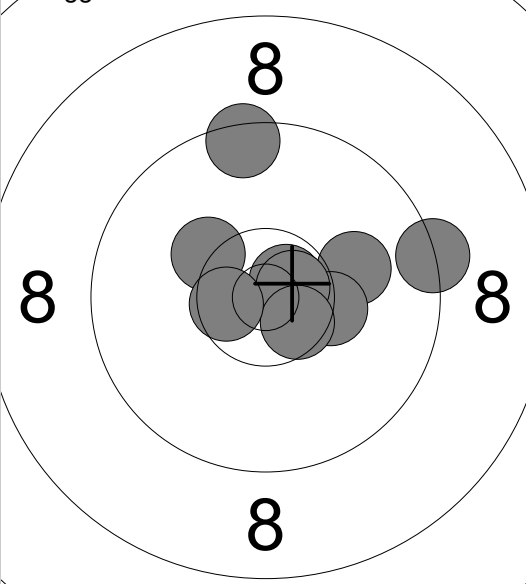
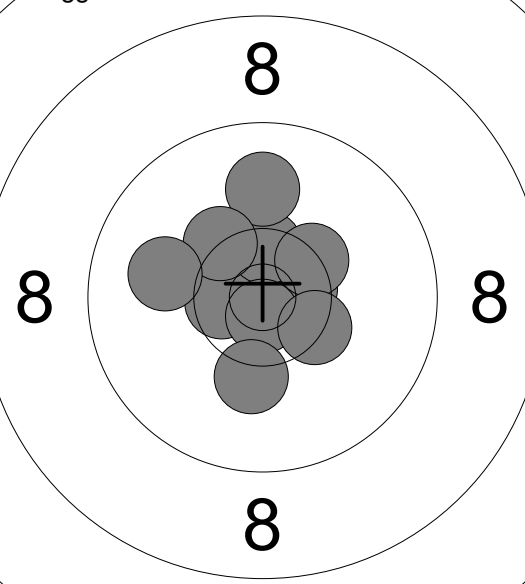
<p>60 Ligg</p>  <p style="text-align: center;"><b>8</b></p>	<p>41: 10.3 ↙</p> <p>42: 10.6x ↗</p> <p>43: 9.5 ↑</p> <p>44: 9.3 →</p> <p>45: 10.1 →</p> <p>46: 10.3x ↗</p> <p>47: 10.7x ↗</p> <p>48: 10.7x ↗</p> <p>49: 10.6x ↘</p> <p>50: 10.6x ↙</p> <p>Serie 102.7</p> <p>Total 513.5</p>	<p>60 Ligg</p>  <p style="text-align: center;"><b>8</b></p>	<p>51: 10.6x ↙</p> <p>52: 10.6x ↗</p> <p>53: 10.5x ↗</p> <p>54: 10.8x ↓</p> <p>55: 9.9 ↑</p> <p>56: 10.4x ↗</p> <p>57: 10.3x ↙</p> <p>58: 10.0 ↙</p> <p>59: 10.4x ↘</p> <p>60: 10.2 ↓</p> <p>Serie 103.7</p> <p>Total 617.2</p>
---	---	---	---

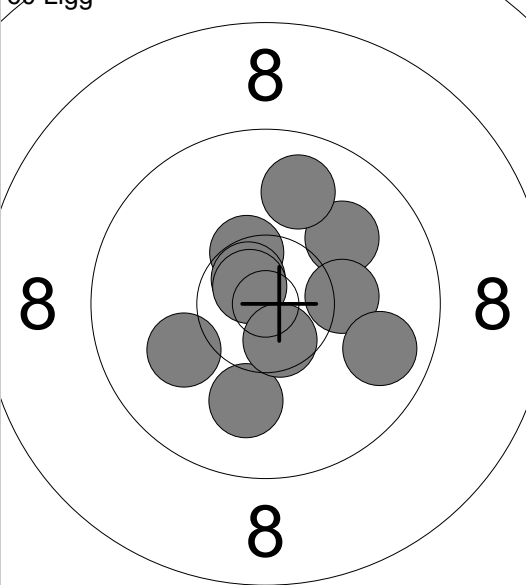
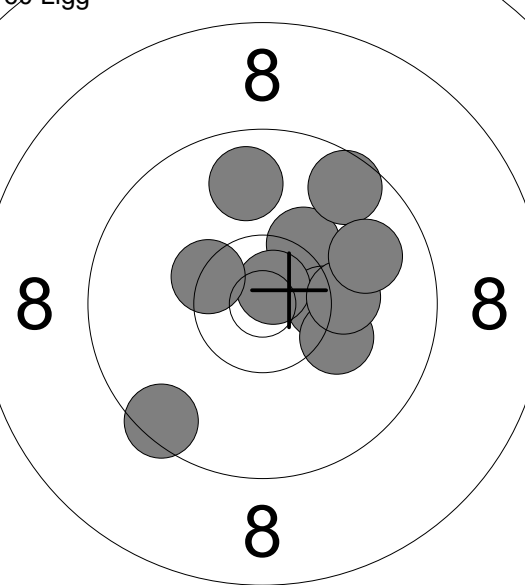
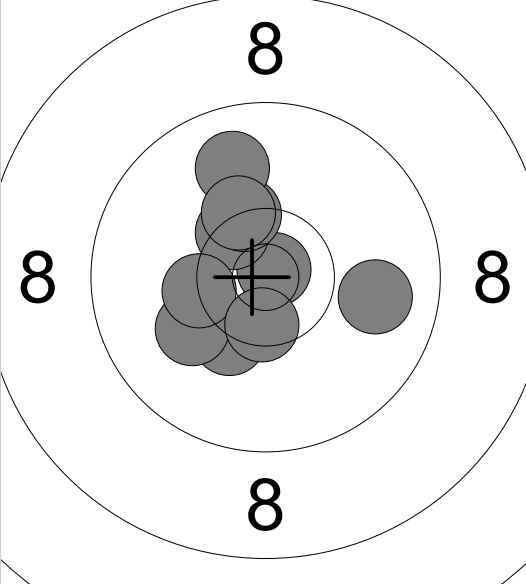
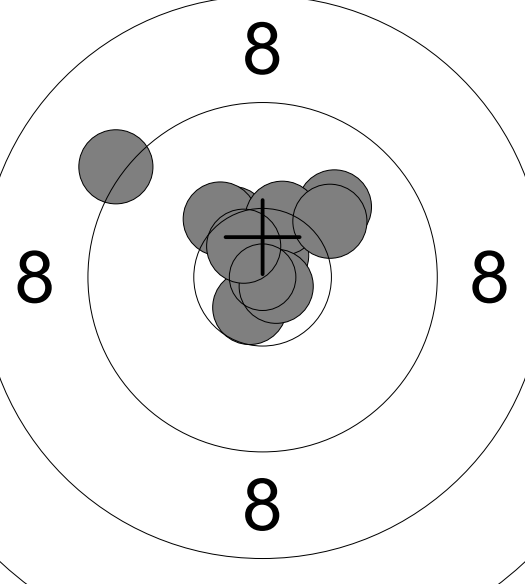
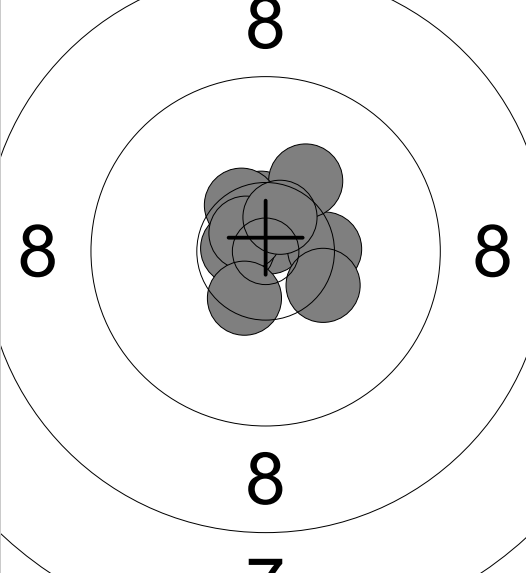
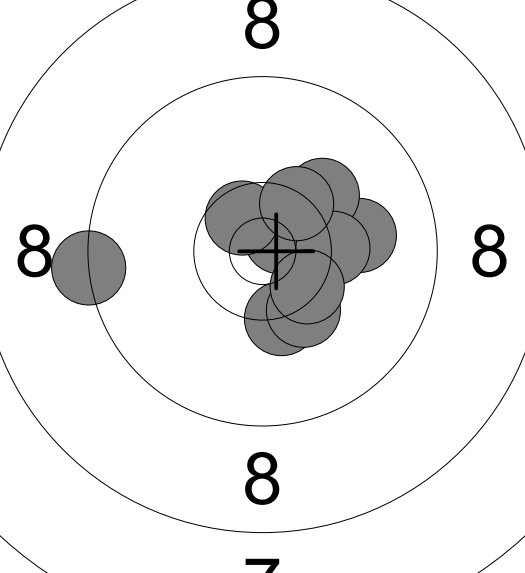
<p>60 Ligg</p>  <p style="text-align: center; font-size: 2em;"><b>8</b></p>	<p>1: 10.0 ↗</p> <p>2: 10.2 →</p> <p>3: 9.9 ↑</p> <p>4: 10.0 ↓</p> <p>5: 10.4x ↗</p> <p>6: 9.8 →</p> <p>7: 10.7x ↗</p> <p>8: 10.1 ↙</p> <p>9: 10.7x ↗</p> <p>10: 10.6x ↓</p>	<p>60 Ligg</p>  <p style="text-align: center; font-size: 2em;"><b>8</b></p>	<p>11: 10.3 ↗</p> <p>12: 10.4x →</p> <p>13: 10.2 →</p> <p>14: 10.8x ↗</p> <p>15: 9.8 ↑</p> <p>16: 9.6 ↗</p> <p>17: 10.4x ↗</p> <p>18: 9.5 ↙</p> <p>19: 10.2 →</p> <p>20: 9.9 →</p>
<b>7</b>	<b>7</b>	<b>7</b>	<b>7</b>
Serie 102.4	Total 102.4	Serie 101.1	Total 203.5
<p>60 Ligg</p>  <p style="text-align: center; font-size: 2em;"><b>8</b></p>	<p>21: 10.8x ↗</p> <p>22: 10.3 ↓</p> <p>23: 10.1 ↙</p> <p>24: 10.4x ↗</p> <p>25: 10.3x ↗</p> <p>26: 9.9 →</p> <p>27: 10.3x ↗</p> <p>28: 9.9 ↑</p> <p>29: 10.3x ↗</p> <p>30: 10.5x ↓</p>	<p>60 Ligg</p>  <p style="text-align: center; font-size: 2em;"><b>8</b></p>	<p>31: 10.4x ↗</p> <p>32: 10.7x ↗</p> <p>33: 10.6x ↓</p> <p>34: 10.0 ↗</p> <p>35: 10.3 ↗</p> <p>36: 9.2 ↙</p> <p>37: 10.4x ↗</p> <p>38: 10.1 ↗</p> <p>39: 10.8x ↗</p> <p>40: 10.6x ↗</p>
<b>7</b>	<b>7</b>	<b>7</b>	<b>7</b>
Serie 102.8	Total 306.3	Serie 103.1	Total 409.4
<p>60 Ligg</p>  <p style="text-align: center; font-size: 2em;"><b>8</b></p>	<p>41: 10.8x ↗</p> <p>42: 10.5x ↗</p> <p>43: 10.4x →</p> <p>44: 10.3x →</p> <p>45: 10.2 ↗</p> <p>46: 10.5x ↗</p> <p>47: 10.7x ↗</p> <p>48: 10.7x ↗</p> <p>49: 10.5x ↓</p> <p>50: 10.6x ↗</p>	<p>60 Ligg</p>  <p style="text-align: center; font-size: 2em;"><b>8</b></p>	<p>51: 10.0 →</p> <p>52: 10.3x ↓</p> <p>53: 10.2 ↗</p> <p>54: 10.7x ↗</p> <p>55: 10.6x ↗</p> <p>56: 10.3 →</p> <p>57: 10.3 ↓</p> <p>58: 9.3 ←</p> <p>59: 10.4x ↗</p> <p>60: 10.4x ↗</p>
<b>7</b>	<b>7</b>	<b>7</b>	<b>7</b>
Serie 105.2	Total 514.6	Serie 102.5	Total 617.1

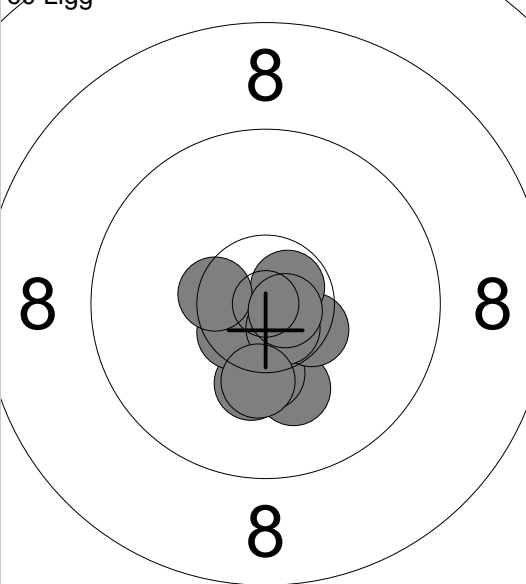
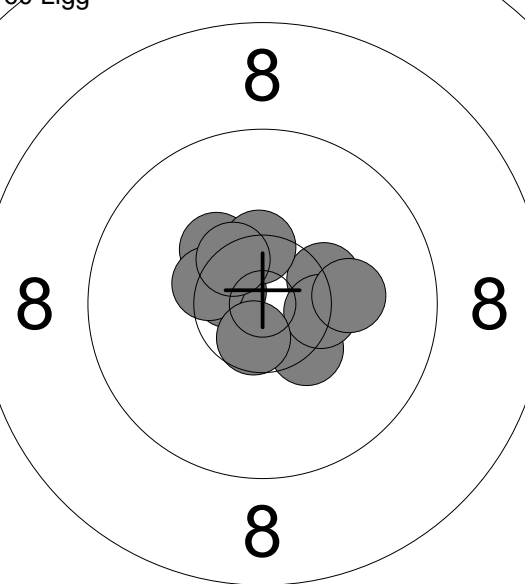
<p>60 Ligg</p> 	<p>1: 10.1 ↓</p> <p>2: 10.2 ↓</p> <p>3: 10.3x ↓</p> <p>4: 10.5x ↘</p> <p>5: 10.5x →</p> <p>6: 10.7x ↗</p> <p>7: 10.7x ↘</p> <p>8: 10.5x ↖</p> <p>9: 10.2 ↓</p> <p>10: 10.8x →</p>	<p>60 Ligg</p> 	<p>11: 10.3x →</p> <p>12: 10.4x ↘</p> <p>13: 10.6x ↖</p> <p>14: 10.4x →</p> <p>15: 10.3 ↖</p> <p>16: 10.4x ↖</p> <p>17: 10.6x ↓</p> <p>18: 10.4x ↑</p> <p>19: 10.4x ↘</p> <p>20: 10.1 →</p>
Serie 104.5	Serie 103.9		
Total 104.5	Total 208.4		

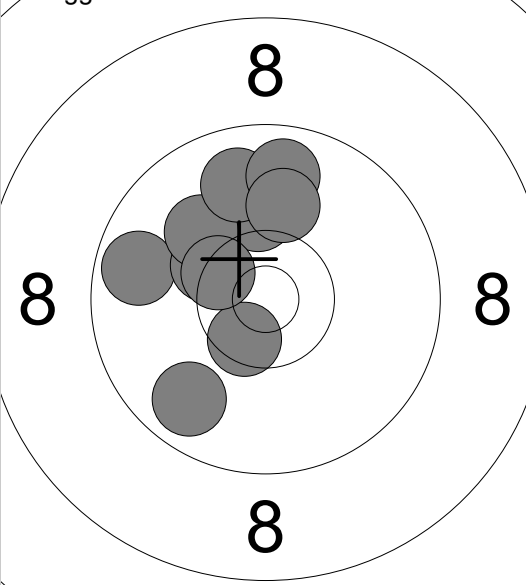
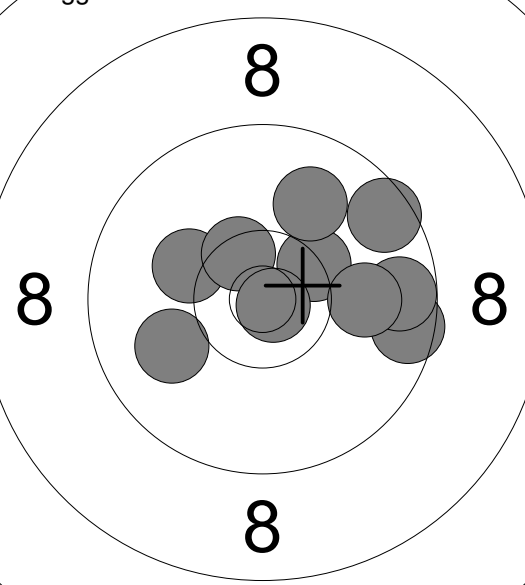
<p>60 Ligg</p> 	<p>21: 9.8 ↙</p> <p>22: 9.7 ←</p> <p>23: 10.5x ↓</p> <p>24: 10.3x ↖</p> <p>25: 10.1 ↑</p> <p>26: 10.1 ↖</p> <p>27: 10.4x ↖</p> <p>28: 9.8 ↑</p> <p>29: 9.8 ↑</p> <p>30: 10.1 ↑</p>	<p>60 Ligg</p> 	<p>31: 10.2 ↖</p> <p>32: 10.5x ↘</p> <p>33: 10.4x ↗</p> <p>34: 9.6 ↗</p> <p>35: 9.6 →</p> <p>36: 9.9 ↑</p> <p>37: 9.7 →</p> <p>38: 10.0 ↙</p> <p>39: 10.8x ↘</p> <p>40: 10.0 →</p>
Serie 100.6	Serie 100.7		
Total 309.0	Total 409.7		

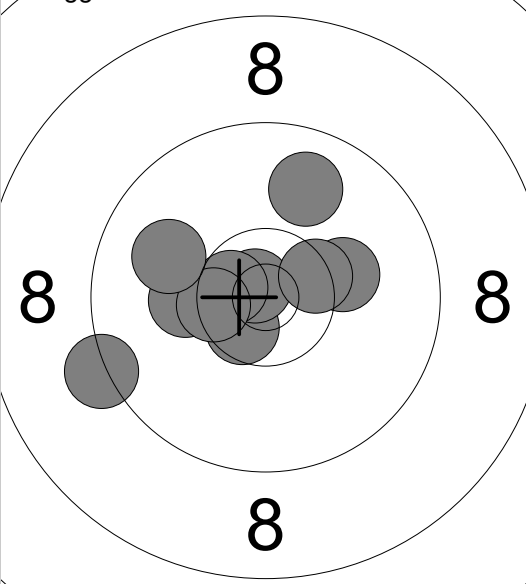
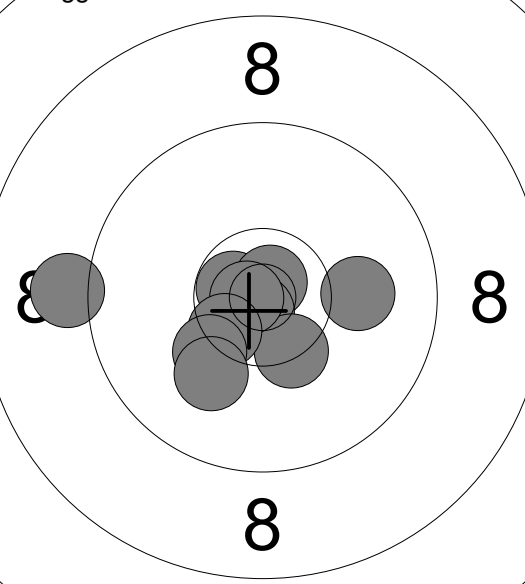
<p>60 Ligg</p> 	<p>41: 10.6x ↘</p> <p>42: 10.2 →</p> <p>43: 10.2 ←</p> <p>44: 10.8x ↘</p> <p>45: 10.4x →</p> <p>46: 10.6x ↖</p> <p>47: 10.4x ↖</p> <p>48: 9.9 ↑</p> <p>49: 9.3 ←</p> <p>50: 10.0 ↖</p>	<p>60 Ligg</p> 	<p>51: 10.7x ↖</p> <p>52: 10.8x ↗</p> <p>53: 10.8x ↓</p> <p>54: 10.4x ↘</p> <p>55: 9.1 ←</p> <p>56: 10.8x ↖</p> <p>57: 10.5x ↘</p> <p>58: 10.2 ↙</p> <p>59: 10.1 ↙</p> <p>60: 10.0 →</p>
Serie 102.4	Serie 103.4		
Total 512.1	Total 615.5		

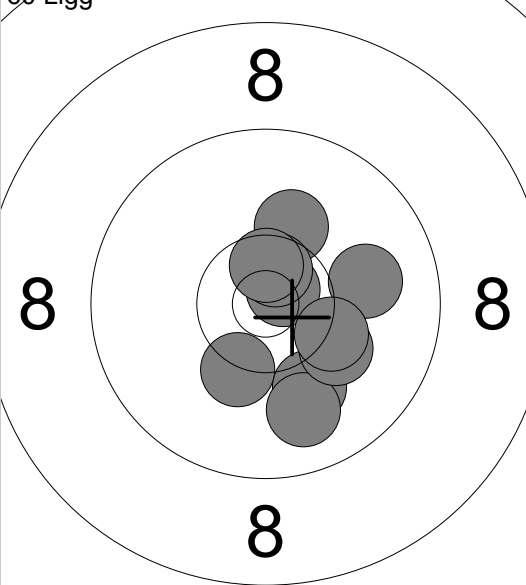
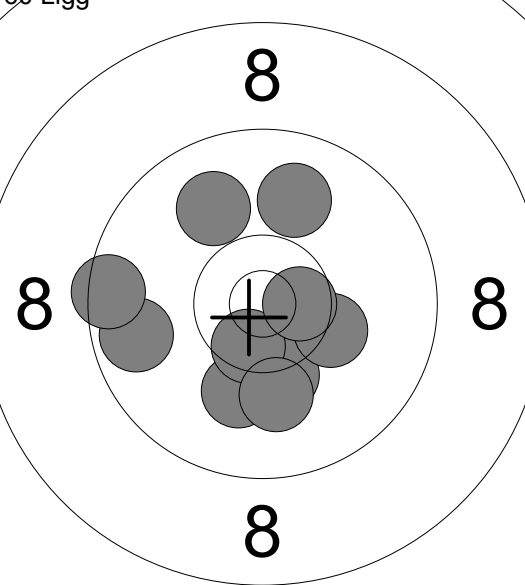
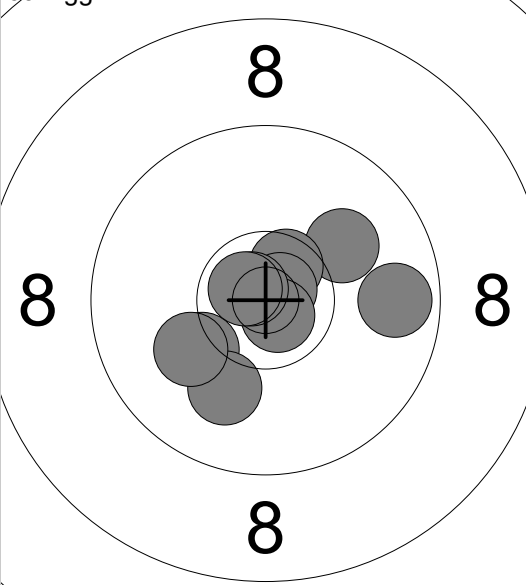
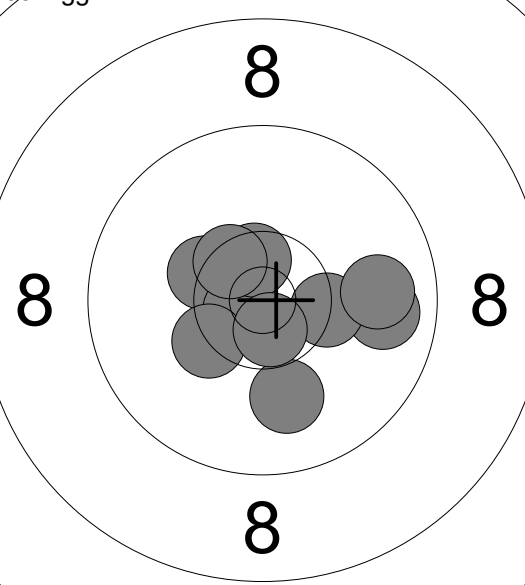
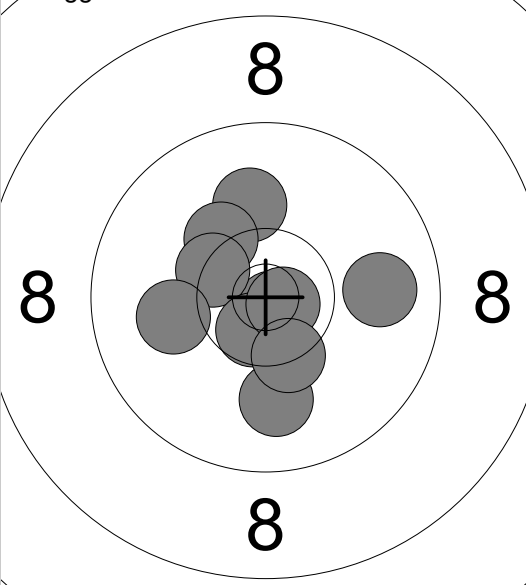
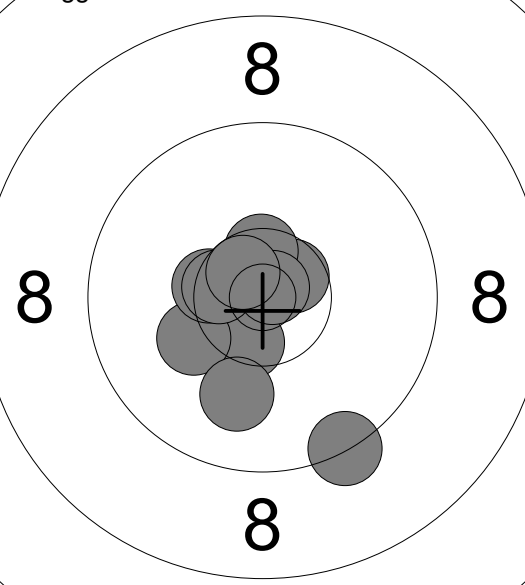
<p>60 Ligg</p>  <p style="text-align: center;">7</p>	<p>1: 10.7x ↗</p> <p>2: 10.1 ↓</p> <p>3: 10.0 →</p> <p>4: 9.9 ↓</p> <p>5: 10.2 →</p> <p>6: 10.2 ↑</p> <p>7: 10.3 →</p> <p>8: 10.6x ↑</p> <p>9: 10.6x ↑</p> <p>10: 10.3 ↓</p> <hr/> <p>Serie 102.9</p> <hr/> <p>Total 102.9</p>	<p>60 Ligg</p>  <p style="text-align: center;">7</p>	<p>11: 9.7 ←</p> <p>12: 10.1 ↓</p> <p>13: 10.3 ↓</p> <p>14: 9.9 ↗</p> <p>15: 10.5x ↓</p> <p>16: 10.1 ↓</p> <p>17: 10.3 →</p> <p>18: 9.9 ↑</p> <p>19: 9.5 ←</p> <p>20: 10.6x →</p> <hr/> <p>Serie 100.9</p> <hr/> <p>Total 203.8</p>
<p>60 Ligg</p>  <p style="text-align: center;">7</p>	<p>21: 10.1 ↗</p> <p>22: 10.6x ↑</p> <p>23: 10.8x ↗</p> <p>24: 9.7 →</p> <p>25: 10.8x ↓</p> <p>26: 10.2 ↙</p> <p>27: 10.0 ↓</p> <p>28: 10.8x ↘</p> <p>29: 10.1 ↙</p> <p>30: 10.7x ↘</p> <hr/> <p>Serie 103.8</p> <hr/> <p>Total 307.6</p>	<p>60 Ligg</p>  <p style="text-align: center;">7</p>	<p>31: 10.3x ↘</p> <p>32: 10.7x ↘</p> <p>33: 9.8 →</p> <p>34: 10.6x ↑</p> <p>35: 10.5x ↘</p> <p>36: 10.0 ↓</p> <p>37: 10.3x ↘</p> <p>38: 10.3x →</p> <p>39: 9.9 →</p> <p>40: 10.7x ↓</p> <hr/> <p>Serie 103.1</p> <hr/> <p>Total 410.7</p>
<p>60 Ligg</p>  <p style="text-align: center;">7</p>	<p>41: 10.1 ↑</p> <p>42: 10.3 ↗</p> <p>43: 10.8x ↓</p> <p>44: 10.4x ↘</p> <p>45: 10.6x ↓</p> <p>46: 10.8x →</p> <p>47: 10.1 ←</p> <p>48: 10.0 ↓</p> <p>49: 9.9 →</p> <p>50: 10.4x ↓</p> <hr/> <p>Serie 103.4</p> <hr/> <p>Total 514.1</p>	<p>60 Ligg</p>  <p style="text-align: center;">7</p>	<p>51: 10.6x ↗</p> <p>52: 10.5x ↓</p> <p>53: 10.2 ↙</p> <p>54: 10.5x ↑</p> <p>55: 10.4x ↘</p> <p>56: 10.5x ↘</p> <p>57: 9.3 ↓</p> <p>58: 10.8x ↗</p> <p>59: 10.0 ↓</p> <p>60: 10.7x ↘</p> <hr/> <p>Serie 103.5</p> <hr/> <p>Total 617.6</p>

<p>60 Ligg</p> <p style="text-align: center;"><b>7</b></p>	<p>60 Ligg</p> <p style="text-align: center;"><b>7</b></p>	<p>60 Ligg</p> <p style="text-align: center;"><b>7</b></p>	<p>60 Ligg</p> <p style="text-align: center;"><b>7</b></p>
<p>60 Ligg</p> <p style="text-align: center;"><b>7</b></p>	<p>60 Ligg</p> <p style="text-align: center;"><b>7</b></p>		

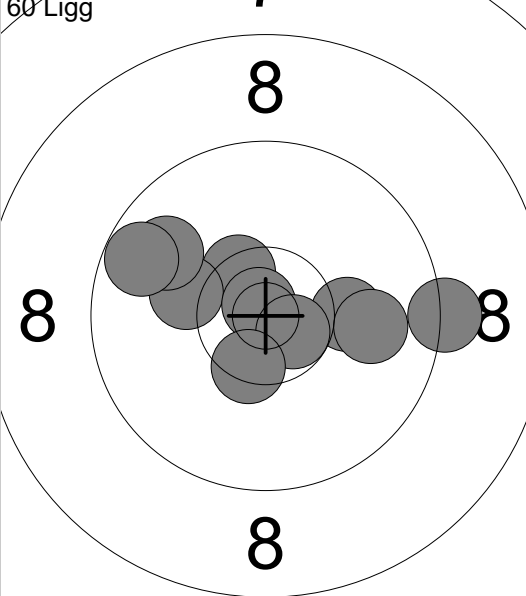
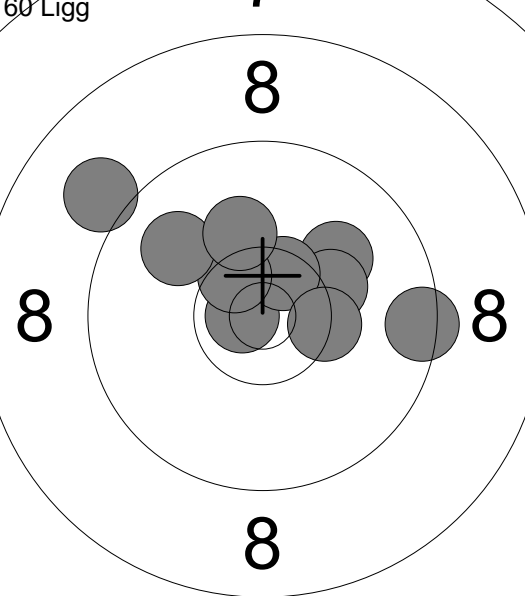
<p>60 Ligg</p> 	<p>1: 10.5x ↗ 2: 10.2 ↙ 3: 10.8x ↗ 4: 9.8 ↖ 5: 9.3 → 6: 10.2 → 7: 10.0 → 8: 10.7x ↘ 9: 9.7 ↖ 10: 10.4x ↘</p> <p>Serie 101.6 Total 101.6</p>	<p>60 Ligg</p> 	<p>11: 10.1 ↗ 12: 9.0 ↖ 13: 10.2 ↗ 14: 10.8x ↖ 15: 10.5x ↗ 16: 10.5x ↖ 17: 9.9 ↖ 18: 10.1 ↖ 19: 10.4x ↘ 20: 9.4 →</p> <p>Serie 100.9 Total 202.5</p>
---	---	---	--

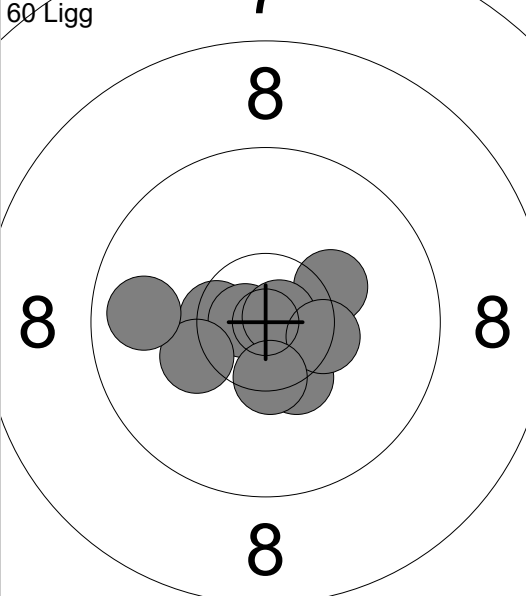
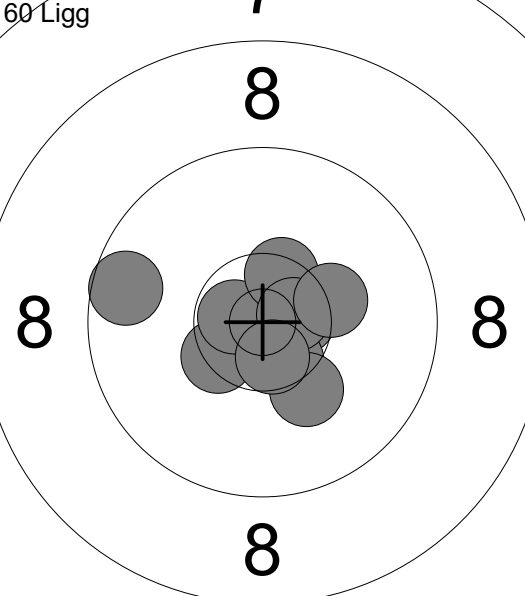
<p>60 Ligg</p> 	<p>21: 10.2 ↗ 22: 10.9x ↘ 23: 10.5x ↖ 24: 10.8x ↖ 25: 10.4x ↘ 26: 10.8x ↗ 27: 10.4x ↘ 28: 10.4x ↘ 29: 10.2 ↖ 30: 9.8 ↖</p> <p>Serie 104.4 Total 306.9</p>	<p>60 Ligg</p> 	<p>31: 10.6x ↘ 32: 10.4x ↘ 33: 9.6 ↖ 34: 10.7x ↖ 35: 10.5x ↘ 36: 10.5x ↗ 37: 10.6x ↘ 38: 10.2 ↘ 39: 10.6x ↘ 40: 10.3 →</p> <p>Serie 104.0 Total 410.9</p>
--	---	--	---

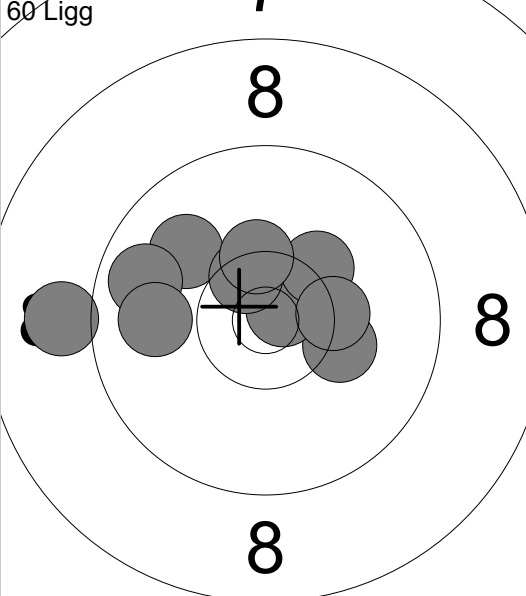
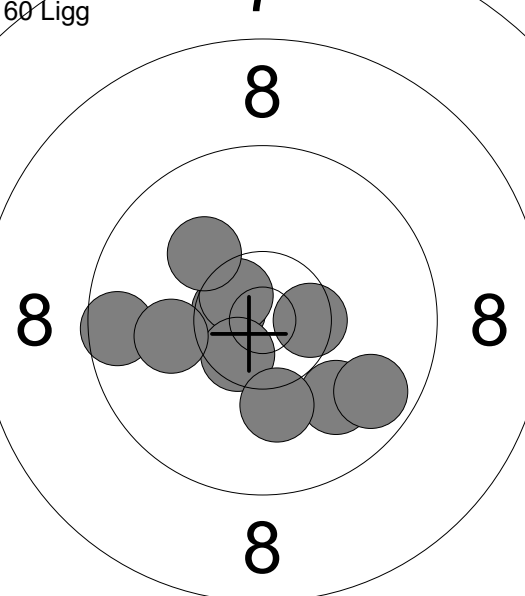
<p>60 Ligg</p> 	<p>41: 10.2 → 42: 10.8x ↗ 43: 10.0 ↖ 44: 10.5x ↗ 45: 10.3 ↗ 46: 9.0 ↖ 47: 9.8 ↖ 48: 10.3x ↘ 49: 9.9 ↖ 50: 10.3x ↗</p> <p>Serie 101.1 Total 512.0</p>	<p>60 Ligg</p> 	<p>51: 10.6x ↖ 52: 10.6x ↖ 53: 9.6 ↖ 54: 10.6x ↘ 55: 10.1 ↖ 56: 10.5x ↘ 57: 10.0 ↘ 58: 9.7 ↘ 59: 10.1 ↘ 60: 10.1 ↖</p> <p>Serie 101.9 Total 613.9</p>
---	--	---	---

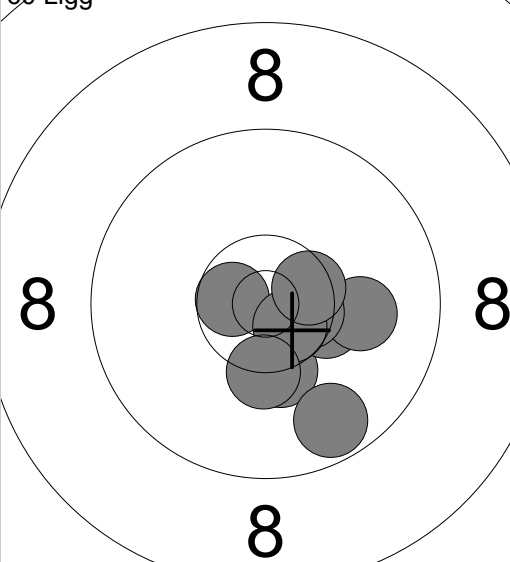
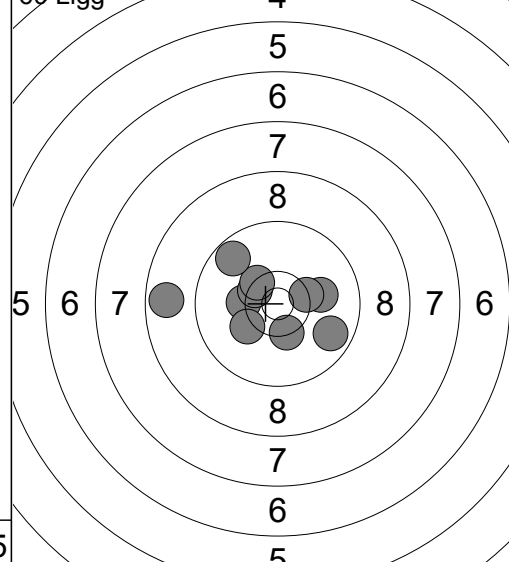
<p>60 Ligg</p> 	<p>60 Ligg</p> 	
<p>1: 10.3x ↘</p> <p>2: 10.5x →</p> <p>3: 10.4x →</p> <p>4: 10.1 →</p> <p>5: 10.6x ↗</p> <p>6: 10.5x →</p> <p>7: 10.6x ↘</p> <p>8: 10.5x →</p> <p>9: 10.3x ↘</p> <p>10: 9.7 ↘</p>	<p>11: 10.1 →</p> <p>12: 10.3 ←</p> <p>13: 10.2 ↙</p> <p>14: 9.7 ↘</p> <p>15: 10.4x ↗</p> <p>16: 10.4x ↘</p> <p>17: 10.4x ↗</p> <p>18: 9.7 ↖</p> <p>19: 10.3x →</p> <p>20: 8.7 ←</p>	
Serie 103.5	Serie 100.2	
Total 103.5	Total 203.7	

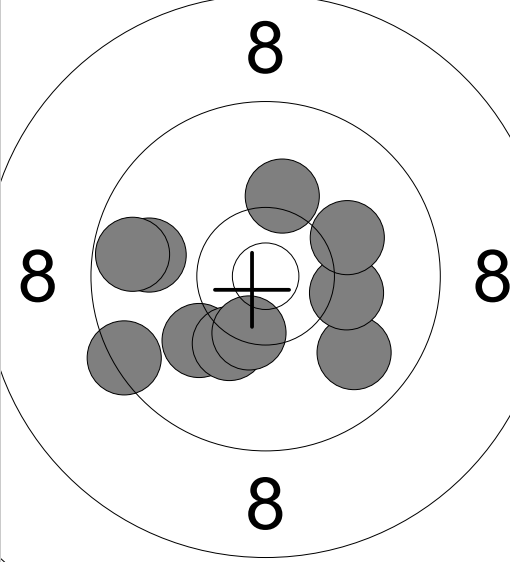
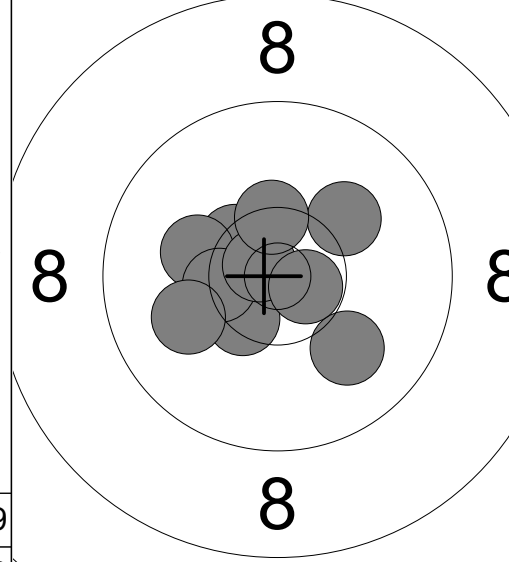
<p>60 Ligg</p> 	<p>60 Ligg</p> 	
<p>21: 10.2 ↑</p> <p>22: 9.8 ↘</p> <p>23: 9.8 ←</p> <p>24: 9.4 ↙</p> <p>25: 10.1 ↙</p> <p>26: 10.2 →</p> <p>27: 10.1 →</p> <p>28: 10.2 ↘</p> <p>29: 10.4x ↘</p> <p>30: 9.7 ←</p>	<p>31: 10.1 ↗</p> <p>32: 10.4x ↗</p> <p>33: 10.4x ↘</p> <p>34: 10.0 ↘</p> <p>35: 10.2 ←</p> <p>36: 10.4x ↗</p> <p>37: 10.7x ↗</p> <p>38: 10.0 ←</p> <p>39: 10.4x ↑</p> <p>40: 10.7x →</p>	
Serie 99.9	Serie 103.3	
Total 303.6	Total 406.9	

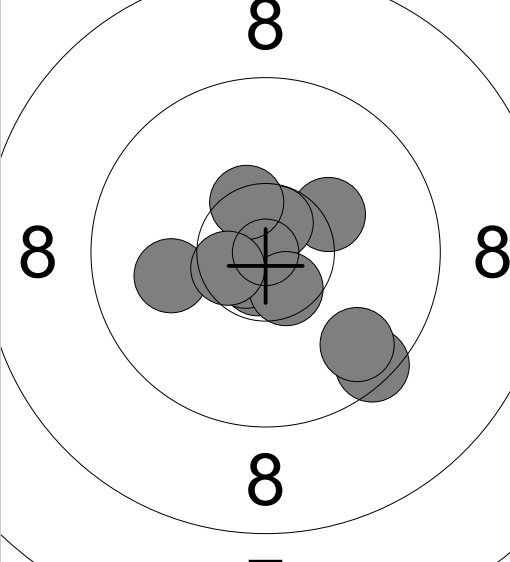
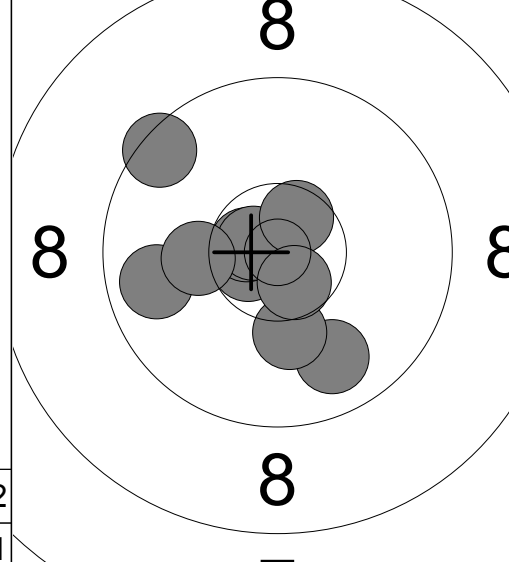
<p>60 Ligg</p> 	<p>60 Ligg</p> 	
<p>41: 10.7x ↘</p> <p>42: 9.5 ↘</p> <p>43: 10.7x ↘</p> <p>44: 10.0 ←</p> <p>45: 9.7 ↘</p> <p>46: 10.3 ↗</p> <p>47: 10.7x ↗</p> <p>48: 10.4x ↗</p> <p>49: 10.6x ↘</p> <p>50: 10.6x ↗</p>	<p>51: 9.8 ↘</p> <p>52: 10.7x ↗</p> <p>53: 10.6x ↗</p> <p>54: 10.7x ↗</p> <p>55: 10.6x ↗</p> <p>56: 9.5 ↖</p> <p>57: 9.8 ←</p> <p>58: 10.2 ↘</p> <p>59: 10.6x ↘</p> <p>60: 10.2 ←</p>	
Serie 103.2	Serie 102.7	
Total 510.1	Total 612.8	

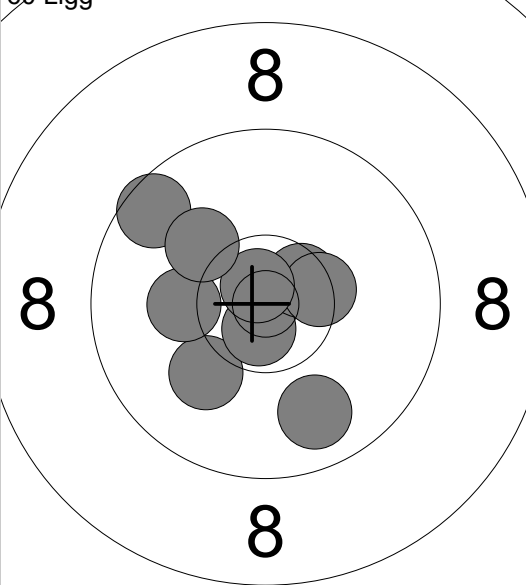
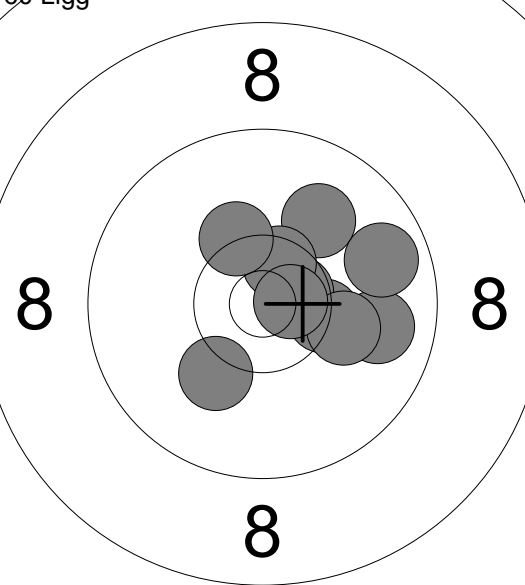
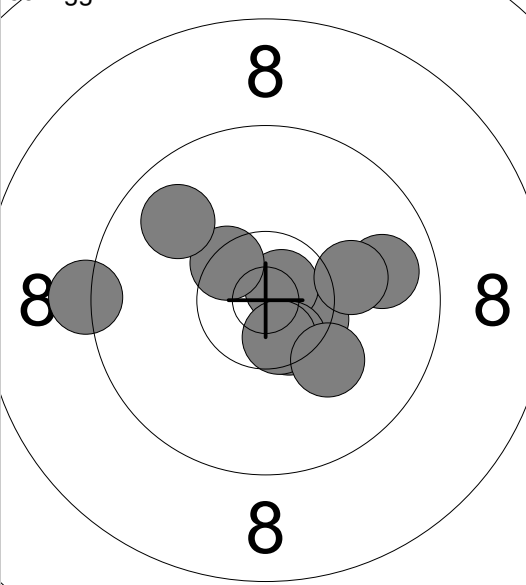
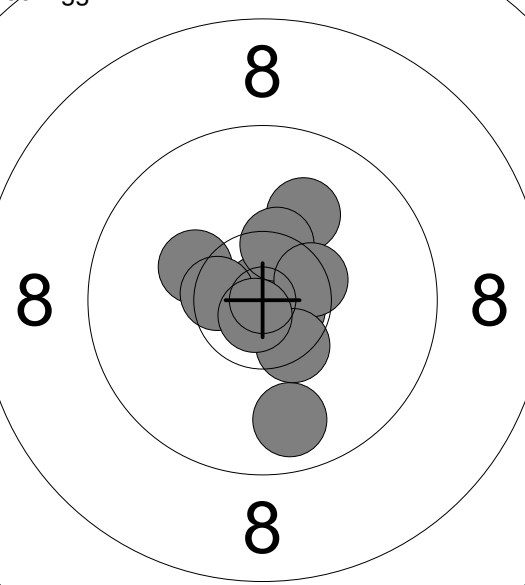
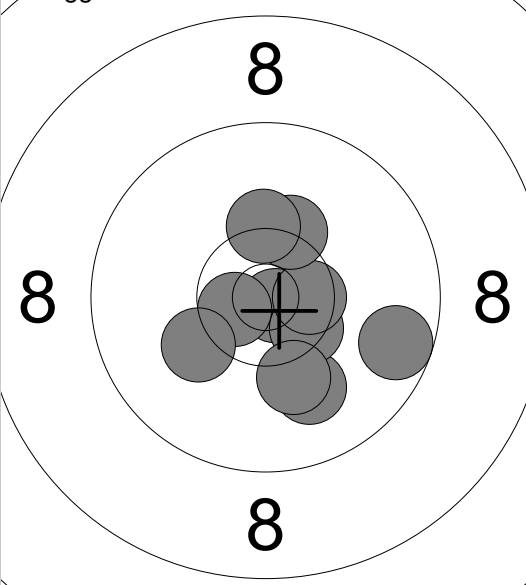
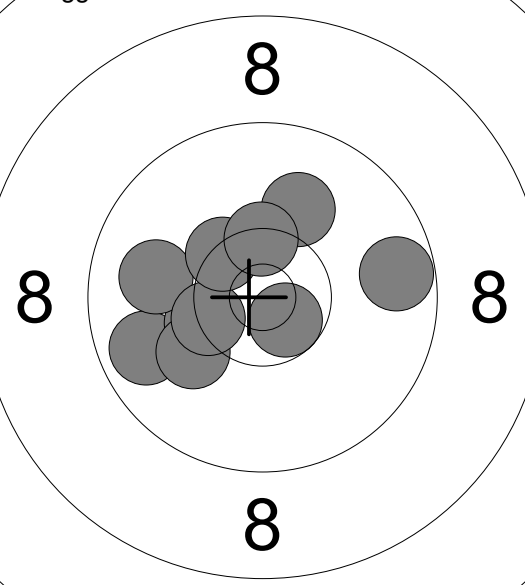
<p>60 Ligg</p>  <p style="text-align: center;"><b>8</b></p>	<p>1: 10.1 ↙</p> <p>2: 10.9x↑</p> <p>3: 10.7x↘</p> <p>4: 10.5x↗</p> <p>5: 9.8 ↓</p> <p>6: 9.6 ↖</p> <p>7: 10.4x→</p> <p>8: 10.2←</p> <p>9: 10.8x↖</p> <p>10: 10.1 ↖</p> <p>Serie 103.1</p> <p>Total 103.1</p>	<p>60 Ligg</p>  <p style="text-align: center;"><b>8</b></p>	<p>11: 9.8 →</p> <p>12: 10.4x→</p> <p>13: 10.6x→</p> <p>14: 10.0 ↗</p> <p>15: 10.5x↖</p> <p>16: 10.2→</p> <p>17: 10.3 ↖</p> <p>18: 9.8 →</p> <p>19: 10.2 ↘</p> <p>20: 10.7x→</p> <p>Serie 102.5</p> <p>Total 205.6</p>
<p>60 Ligg</p>  <p style="text-align: center;"><b>8</b></p>	<p>21: 10.5x→</p> <p>22: 10.8x↗</p> <p>23: 10.5x↘</p> <p>24: 9.8 →</p> <p>25: 10.6x↘</p> <p>26: 9.3 ←</p> <p>27: 10.4x↖</p> <p>28: 10.1→</p> <p>29: 10.1 ↘</p> <p>30: 9.8 ↖</p> <p>Serie 101.9</p> <p>Total 307.5</p>	<p>60 Ligg</p>  <p style="text-align: center;"><b>8</b></p>	<p>31: 10.7x→</p> <p>32: 10.1 ↗</p> <p>33: 10.9x↖</p> <p>34: 10.2↖</p> <p>35: 9.8 ↓</p> <p>36: 10.5x↖</p> <p>37: 10.4x↖</p> <p>38: 10.5x→</p> <p>39: 10.4x↘</p> <p>40: 10.8x↘</p> <p>Serie 104.3</p> <p>Total 411.8</p>
<p>60 Ligg</p>  <p style="text-align: center;"><b>8</b></p>	<p>41: 10.0 ↓</p> <p>42: 10.8x↘</p> <p>43: 10.5x↘</p> <p>44: 10.2 ↓</p> <p>45: 10.5x→</p> <p>46: 10.3x↖</p> <p>47: 10.6x↖</p> <p>48: 9.7 →</p> <p>49: 10.2↖</p> <p>50: 10.3 ↑</p> <p>Serie 103.1</p> <p>Total 514.9</p>	<p>60 Ligg</p>  <p style="text-align: center;"><b>8</b></p>	<p>51: 9.8 ←</p> <p>52: 10.3x↖</p> <p>53: 9.9 ←</p> <p>54: 10.1↖</p> <p>55: 10.1 ↗</p> <p>56: 10.4x↖</p> <p>57: 9.7 →</p> <p>58: 10.6x↘</p> <p>59: 10.4x↖</p> <p>60: 10.4x↖</p> <p>Serie 101.7</p> <p>Total 616.6</p>



<p>60 Ligg</p>	<p>1: 10.1 ↘ 2: 10.5x ↘ 3: 10.8x ↘ 4: 10.5x ↗ 5: 10.8x ↘ 6: 10.4x ↗ 7: 10.5x ↘ 8: 10.0 → 9: 10.7x ↗ 10: 10.1 ↖</p> <p>Serie 104.4 Total 104.4</p>	<p>60 Ligg</p> <p>11: 10.2 ↙ 12: 10.2 ↘ 13: 9.9 → 14: 10.5x ↘ 15: 10.1 ← 16: 10.3x ↗ 17: 10.6x ↗ 18: 9.6 → 19: 9.4 → 20: 10.7x ↗</p> <p>Serie 101.5 Total 205.9</p>
<p>60 Ligg</p>	<p>21: 10.6x ↘ 22: 10.6x ↘ 23: 9.7 → 24: 10.5x ↘ 25: 10.4x ↗ 26: 10.4x ↗ 27: 9.7 ↘ 28: 9.6 → 29: 10.9x ↘ 30: 9.6 ↙</p> <p>Serie 102.0 Total 307.9</p>	<p>60 Ligg</p> <p>31: 9.6 ↙ 32: 9.6 ← 33: 9.3 ↙ 34: 9.3 ← 35: 10.1 ← 36: 9.6 ↙ 37: 8.7 ← 38: 9.2 ↗ 39: 9.5 → 40: 9.5 →</p> <p>Serie 94.4 Total 402.3</p>
<p>60 Ligg</p>	<p>41: 10.7x ↗ 42: 10.8x ↗ 43: 9.7 ↑ 44: 10.8x ↘ 45: 10.2 ↖ 46: 9.5 ↗ 47: 10.1 ↗ 48: 10.6x ↗ 49: 10.1 ↑ 50: 9.9 ↑</p> <p>Serie 102.4 Total 504.7</p>	<p>60 Ligg</p> <p>51: 10.2 ← 52: 10.4x ↘ 53: 9.8 ↑ 54: 10.3x ↗ 55: 10.5x ↗ 56: 10.6x ↗ 57: 9.6 ↗ 58: 9.9 ↑ 59: 8.6 ← 60: 10.9x ↘</p> <p>Serie 100.8 Total 605.5</p>

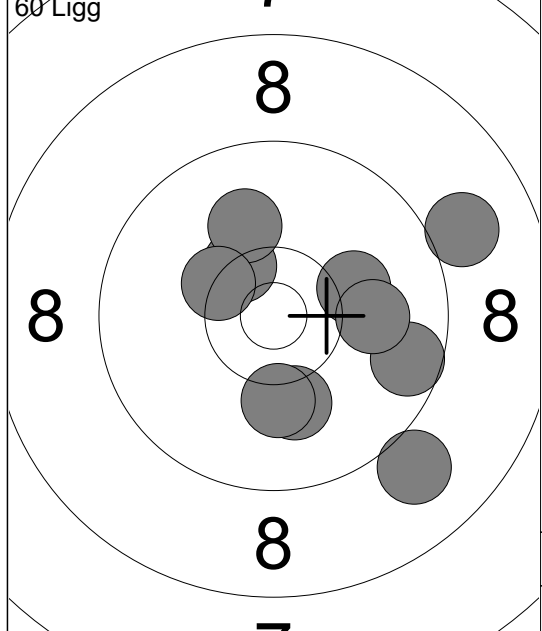

1:	10.2	→
2:	9.6	→
3:	10.4	↘
4:	10.1	↓
5:	10.1	↑
6:	10.2	↓
7:	10.0	→
8:	9.0	↘
9:	10.3	↘
10:	9.0	→
Serie		98.9
Total		98.9

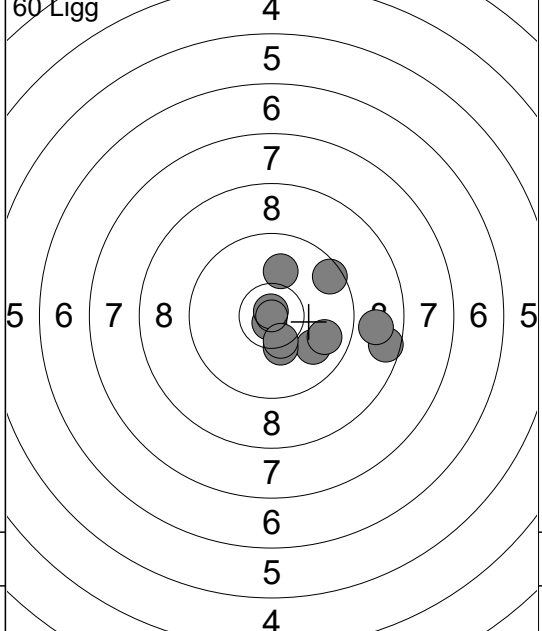

11:	10.8	↘
12:	9.5	↗
13:	10.0	↑
14:	9.9	↘
15:	8.6	→
16:	8.8	→
17:	10.3	↘
18:	10.9	↑
19:	10.4	↘
20:	9.8	→
Serie		99.0
Total		197.9

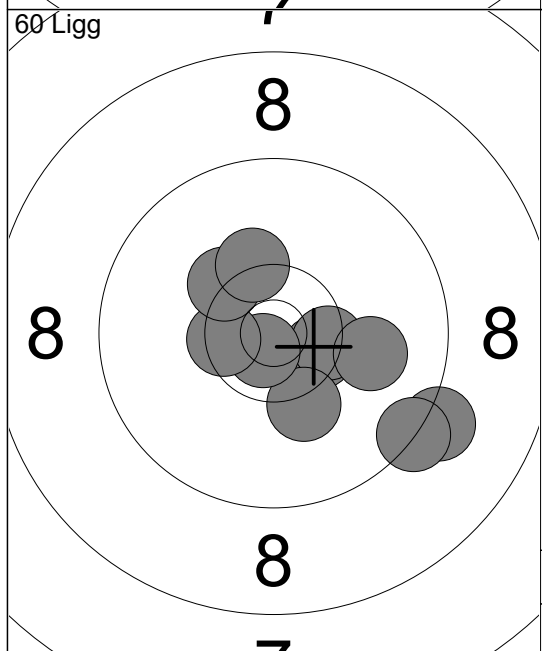

21:	9.2	↘
22:	10.5	↘
23:	9.3	↘
24:	10.4	↘
25:	10.0	→
26:	10.2	↓
27:	10.8	↘
28:	10.5	↘
29:	10.3	↘
30:	10.3	↑
Serie		101.5
Total		299.4

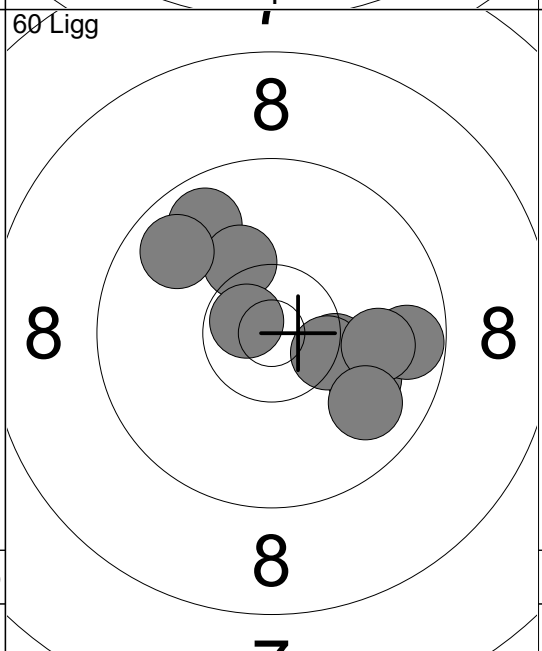

31:	9.8	↖
32:	10.3	↘
33:	10.2	↑
34:	10.7	↘
35:	9.8	↖
36:	10.0	→
37:	10.4	↘
38:	9.7	→
39:	9.9	→
40:	9.8	↘
Serie		100.6
Total		400.0

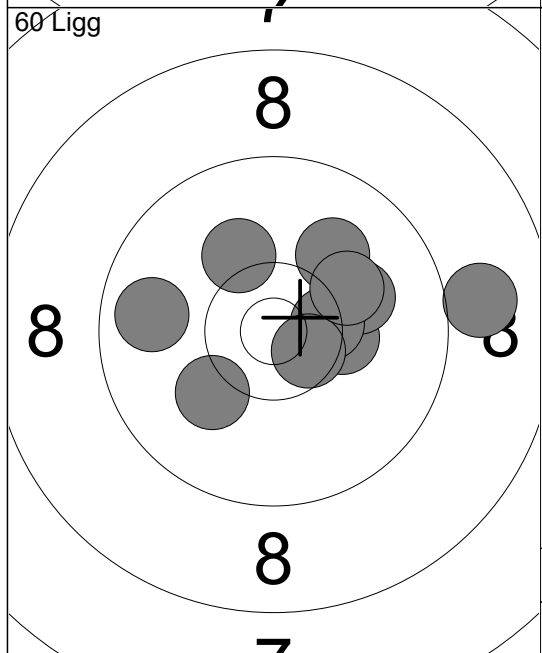

41:	9.8	←
42:	10.2	↑
43:	10.0	↗
44:	10.1	↙
45:	9.0	→
46:	10.3	↘
47:	10.1	→
48:	10.4	↘
49:	10.6	↘
50:	10.1	↗
Serie		100.6
Total		500.6

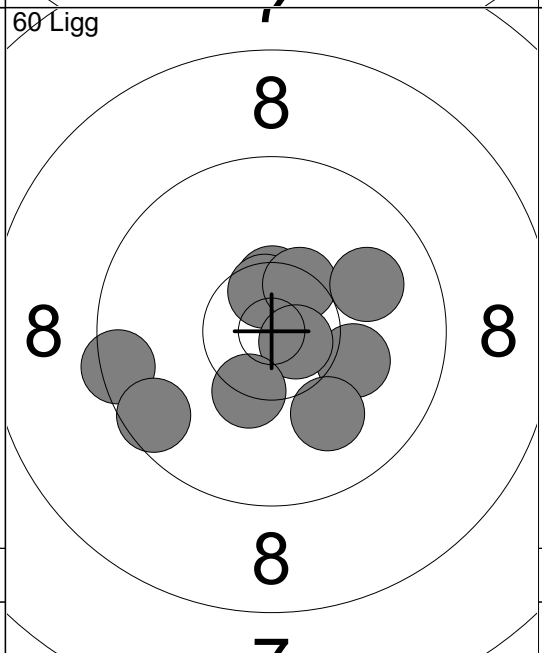

51:	10.5	↑
52:	10.1	→
53:	10.6	↑
54:	10.0	↓
55:	10.4	↗
56:	9.5	←
57:	9.6	↙
58:	10.0	↗
59:	10.7	↘
60:	10.4	↘
Serie		101.8
Total		602.4

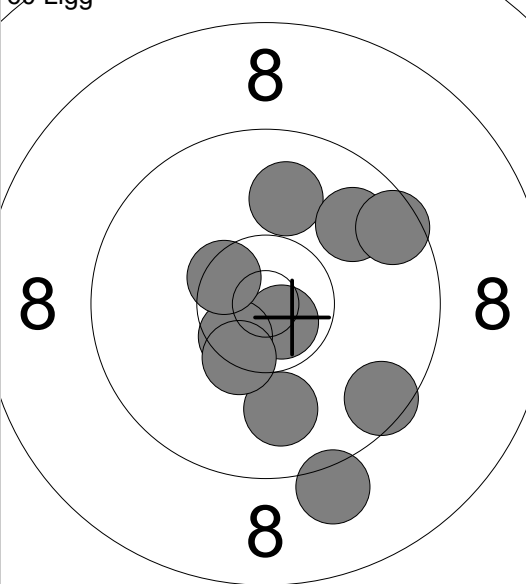
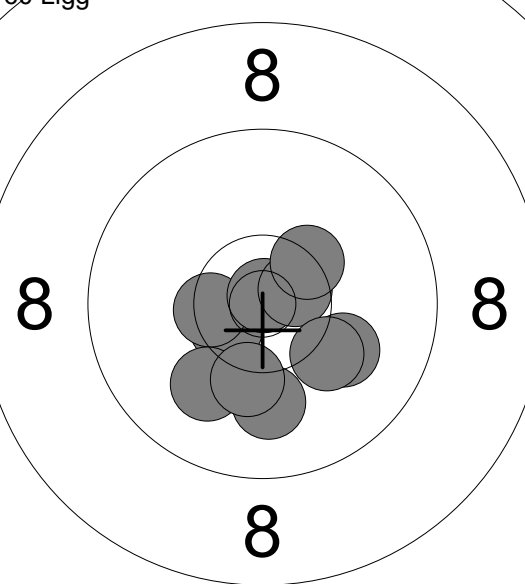
<p>60 Ligg</p>  <p style="text-align: center; font-size: 2em;"><b>8</b></p>	<p>1: 10.7x ↘                  2: 9.9 ↓                  3: 10.5x ↘                  4: 10.4x ↘                  5: 9.9 ↑                  6: 9.8 ↗                  7: 9.5 ↗                  8: 9.1 ↓                  9: 9.5 ↘                  10: 10.5x ↘</p> <p>Serie 99.8</p> <p>Total 99.8</p>	<p>60 Ligg</p>  <p style="text-align: center; font-size: 2em;"><b>8</b></p>	<p>11: 10.1 ↘                  12: 10.5x ↘                  13: 10.0 ↓                  14: 10.5x ↘                  15: 10.9x ↗                  16: 10.6x ↗                  17: 10.0 ↓                  18: 10.2 ↘                  19: 10.2 ↓                  20: 10.4x ↗</p> <p>Serie 103.4</p> <p>Total 203.2</p>
---	--	---	--

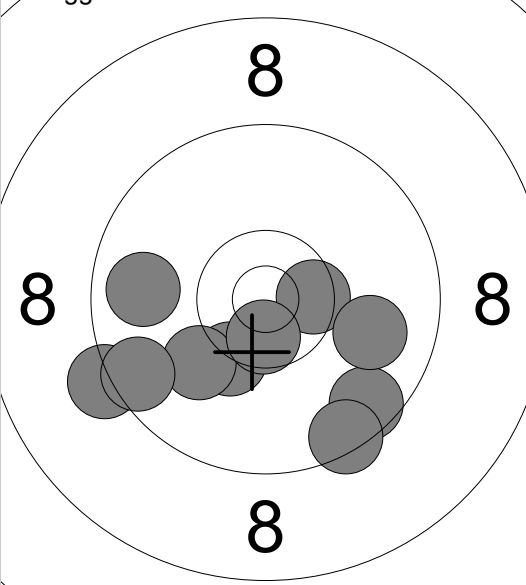
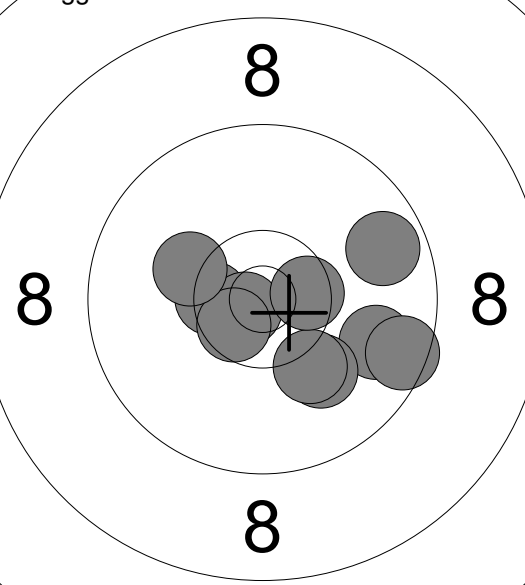
<p>60 Ligg</p>  <p style="text-align: center; font-size: 2em;"><b>8</b></p>	<p>21: 10.3x ↘                  22: 10.1 ↘                  23: 9.6 ↓                  24: 9.4 ↓                  25: 10.5x ↗                  26: 9.9 →                  27: 9.2 ←                  28: 9.6 ←                  29: 9.8 ←                  30: 10.6x ↓</p> <p>Serie 99.0</p> <p>Total 302.2</p>	<p>60 Ligg</p>  <p style="text-align: center; font-size: 2em;"><b>8</b></p>	<p>31: 10.5x ↘                  32: 9.8 →                  33: 10.8x ↘                  34: 10.1 ↓                  35: 10.6x ↘                  36: 10.2 ↘                  37: 10.2 ↓                  38: 9.7 →                  39: 9.5 →                  40: 10.5x ↗</p> <p>Serie 101.9</p> <p>Total 404.1</p>
--	---	--	--

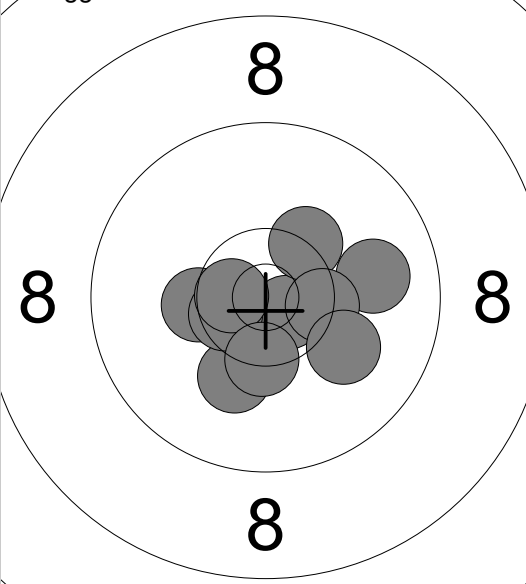
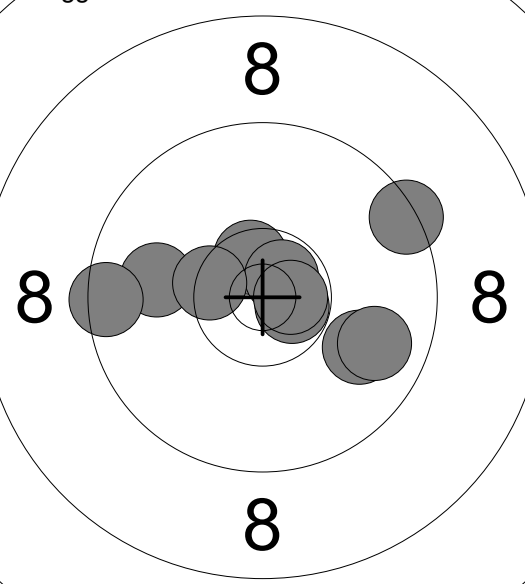
<p>60 Ligg</p>  <p style="text-align: center; font-size: 2em;"><b>8</b></p>	<p>41: 10.3x ↘                  42: 9.9 →                  43: 10.7x ↘                  44: 10.3x ↗                  45: 10.2 ↓                  46: 10.4x ↗                  47: 10.5x ↘                  48: 10.6x ↘                  49: 10.4x ↓                  50: 10.1 ↘</p> <p>Serie 103.4</p> <p>Total 507.5</p>	<p>60 Ligg</p>  <p style="text-align: center; font-size: 2em;"><b>8</b></p>	<p>51: 9.9 ←                  52: 10.7x ↗                  53: 10.6x ↗                  54: 9.5 ←                  55: 10.7x ↗                  56: 9.9 →                  57: 9.8 →                  58: 9.4 ↗                  59: 10.4x ↘                  60: 10.7x ↗</p> <p>Serie 101.6</p> <p>Total 609.1</p>
---	---	---	---